

BD FACSAria™ Fusion User's Guide

For Research Use Only

bdbiosciences.com
23-14816-00
8/2013



Becton, Dickinson and Company
BD Biosciences
2350 Qume Drive
San Jose, CA 95131 USA
Tel 877.232.8995
Fax 408.954.2347
ResearchApplications@bd.com

BD Biosciences
European Customer Support
Tel +32.2.400.98.95
Fax +32.2.401.70.94
help.biosciences@europe.bd.com

Copyrights

© 2013, Becton, Dickinson and Company. All rights reserved. No part of this publication may be reproduced, transmitted, transcribed, stored in retrieval systems, or translated into any language or computer language, in any form or by any means: electronic, mechanical, magnetic, optical, chemical, manual, or otherwise, without prior written permission from BD Biosciences.

The information in this guide is subject to change without notice. BD Biosciences reserves the right to change its products and services at any time to incorporate the latest technological developments. Although this guide has been prepared with every precaution to ensure accuracy, BD Biosciences assumes no liability for any errors or omissions, nor for any damages resulting from the application or use of this information. BD Biosciences welcomes customer input on corrections and suggestions for improvement.

Trademarks

Alexa Fluor®, Cascade Blue®, and Texas Red® are registered trademarks and Pacific Blue™ is a trademark of Life Technologies Corporation.

Clorox is a registered trademark of The Clorox Company.

Contrad is a registered trademark of Decon Labs, Inc.

Cy™ is a trademark of GE Healthcare. Cy™ dyes are subject to proprietary rights of GE Healthcare and Carnegie Mellon University and are made and sold under license from GE Healthcare only for research and in vitro diagnostic use. Any other use requires a commercial sublicense from GE Healthcare, 800 Centennial Avenue, Piscataway, NJ 08855-1327, USA.

Eppendorf is a registered trademark of Eppendorf AG.

FlexAIR is a registered trademark of The Baker Company.

Fluoresbrite is a registered trademark of Polysciences, Inc.

Kimwipes is a registered trademark of Kimberly-Clark Corporation.

Lauda is a registered trademark of Metrohm USA, Inc.

Living Colors is a registered trademark of Clontech.

Microsoft, Windows, and Excel are registered trademarks of Microsoft Corporation.

SPHERO is a trademark of Spherotech, Inc.

Teflon is a registered trademark of E.I. du Pont de Nemours and Company.

BD, BD Logo and all other trademarks are property of Becton, Dickinson and Company. © 2013

Patents

APC-Cy7: US 5,714,386

Regulatory information

Class 1 Laser Product.

For Research Use Only. Not for use in diagnostic or therapeutic procedures.

FCC Information

WARNING: Changes or modifications to this unit not expressly approved by the party responsible for compliance could void the user's authority to operate the equipment.

NOTICE: This equipment has been tested and found to comply with the limits for a Class A digital device, pursuant to Part 15 of the FCC Rules. These limits are designed to provide reasonable protection against harmful interference when the equipment is operated in a commercial environment. This equipment generates, uses, and can radiate radio frequency energy and, if not installed and used in accordance with the instruction manual, may cause harmful interference to radio communications. Operation of this equipment in a residential area is likely to cause harmful interference in which case the user will be required to correct the interference at his or her own expense.

Shielded cables must be used with this unit to ensure compliance with the Class A FCC limits.

This Class A digital apparatus meets all requirements of the Canadian Interference-Causing Equipment Regulations.

Cet appareil numérique de la classe A respecte toutes les exigences du Règlement sur le matériel brouilleur du Canada.

History

Revision	Date	Change Made
23-14816-00	8/2013	Initial release

Contents

About This Guide	xiii
Conventions	xiv
Technical Assistance	xv
Limitations	xvi
Chapter 1: System Components	17
BD FACSAria Fusion System	18
Workstation	19
Biosafety Cabinet	20
Flow Cytometer	21
Fluidics System	22
Optics System	35
Cytometer Electronics	43
Emergency Stop Button	44
Chapter 2: Theory of Operation	47
Fluid Movement	48
Sheath Flow	49
Sample Flow	50
Signal Generation	52
Light Scatter	52
Fluorescence Signals	53

Signal Detection	54
Detector Arrays	54
Filters	55
Detectors	59
Electronic Processing	60
Pulse Parameters	61
Laser Delay	63
Sorting	64
Drop Formation	65
Side Stream Formation	69
Drop Charging	72
Conflict Resolution During Sorting	73
Chapter 3: Using BD FACSDiva Software	81
Workspace Components	82
Cytometer Controls	83
Fluidics Controls	83
Fluidics Level Indicators	86
Cytometer Configuration	87
Cytometer Status Report	90
Custom Configurations	92
Acquisition Controls	100
Sorting Controls	101
Sort Menu	102
Sort Setup	103
Sort Report	112
Templates	114

Chapter 4: Startup and Running Samples	115
Cytometer Startup	116
Performing Fluidics Startup	119
Starting the Stream	121
Setting Up the Breakoff	123
Setting Up the Fluidics	126
Checking Cytometer Performance	134
Preparing the CS&T Workspace	135
Preparing the BD FACSDiva CS&T Research Beads	138
Running a Performance Check	138
Reviewing the Results	139
CST Mismatch Dialog	140
Application Settings	141
Creating Application Settings	142
Data Collection	148
Setting Up the Workspace	148
Calculating Compensation	152
Data Recording and Analysis	155
Setting Up the Experiment	156
Setting Up the Global Worksheet	157
Recording Data	159
Analyzing Data	160
Performing a Batch Analysis	162
Manual Adjustment of Laser Delay	164
Chapter 5: Sorting	169
Setting Up for Sorting	170
Setting Up for Bulk Sorting	171
Determining the Drop Delay – Manual Method	176
Setting Up the Experiment	176
Using Manual Drop Delay	178

Determining the Drop Delay – Automatic Method	181
Overview of Auto Drop Delay	181
Using Auto Drop Delay	181
Sorting	183
Setting Up the Experiment	184
Starting and Monitoring the Sort	185
Stopping and Resuming a Sort	187
Pausing and Resuming a Sort	189
Responding to a Nozzle Clog During a Sort	190
Setting Up for Sorting onto a Plate or Slide	192
Installing the Sorting Hardware	192
Setting Up the Stream	194
Creating a Custom Device	197
Index Sorting	199
Setting Up for Index Sorting	199
Terasaki Plate Adapter	203
Using the Adapter	203
Using the Correct Device in the Sort Layout	204
Chapter 6: Shutdown and Maintenance	205
Daily Shutdown	206
Cleaning the Flow Cell (Daily)	206
Fluidics Shutdown (Weekly or As Needed)	207
External Cleaning	210
Scheduled Maintenance	211
Internal Cleaning	212
Purging the Fluid Filters	217
Purging the Sheath Filter	218
Changing the Fluid Filters	218
Changing the Sheath Filter	219
Changing the Ethanol Shutdown Filter	220

Changing the Sample Lines	221
Changing the Air Filter	229
Changing the Sheath Tank Air Filter	229
Unscheduled Maintenance	230
Changing the Integrated Nozzle	231
Cleaning the Integrated Nozzle	233
Handling the Integrated Nozzle	235
Temporary Replacement of a Seal	236
Closed-Loop Nozzle Maintenance	237
Installing or Removing a Sample Line Filter	239
Changing the Pinch Valve Tubing	241
Cleaning the Camera Windows	244
Removing the Deflection Plates	247
Lubricating the Sample Injection Chamber O-Ring	248
Using Custom Optical Filters	249
Cleaning the Optical Filters	250
Removing or Installing the FSC ND Filter	251
Chapter 7: Troubleshooting	253
Troubleshooting the Stream	254
Troubleshooting the Breakoff	259
Sorting Troubleshooting	260
Acquisition Troubleshooting	265
Fluidics Troubleshooting	272
Electronics Troubleshooting	274
Chapter 8: Supplies and Consumables	275
Cytometer Supplies	276
Optical Components	276
Accessory Kit	278
Other Replacement Parts	281

Consumables	282
Cytometer Setup Particles	282
Reagents	283
Labware	284
Chapter 9: Laser Options	285
Planning Considerations	286
Optics Choices for the 375-nm Laser	286
Optics Changes When Using the 445-nm Laser	286
Using a Fluorochrome with Multiple Lasers	286
Detector Locations	287
Detector Configurations	289
488/640 Two-Laser System	289
488/640/405 Three-Laser System	291
488(445)/561/640 Four-Laser System	293
488(445)/640/405(375) Five-Laser System	295
488(445)/561/640/405(375) Six-Laser System	297
Fifth PMT in the 561-nm Octagon	301
Chapter 10: BD Aerosol Management Option	303
Option Components	304
Evacuator	304
ULPA Filter	305
Operating the BD Aerosol Management Option	306
Starting Up the Evacuator	306
Setting Up for Sorting	309
Responding to a Nozzle Clog During a Sort with the AMO	310
Turning Off the Evacuator	312
Maintenance	312
Replacing the ULPA Filter	313
Replacing the Air Filter	317

Upgrades for the AMO	319
Troubleshooting	320
Control Panel Troubleshooting	321
Filter Flow Gauge Troubleshooting	322
Specifications	323
Chapter 11: Biosafety Cabinet Option	325
Biosafety Cabinet Overview	326
View Screen	327
Sash	328
Safe Work Access Opening	328
Ready Safe Mode	329
Storage Cabinet	329
Cabinet Gauge and Controls	329
Aerosol Management System	333
AMS Gauge and Controls	333
Operating the AMS	335
Responding to a Nozzle Clog During a Sort	336
Working in the BSC	338
Cleaning the BSC	339
Materials	339
Procedure	339
Cleaning the Base Pan	340
Materials	340
Procedure	341
Replacing the Electronics Cable Plastic Sleeve	343
Ergonomics Safety Guidelines	344

Chapter 12: Temperature Control Option	345
Option Components	346
Using the BD Temperature Control Option	347
Setting Up the Water Bath	347
Setting Up the Tube Holder	349
Setting Up the ACDU Stage	350
Starting Up the Water Bath	353
Maintenance	354
Tube Holders	354
Recirculating Water Tubing	354
Specifications	355
Index	357

About This Guide

This user's guide contains the instructions necessary to operate and maintain your BD FACSAria™ Fusion flow cytometer. Because many instrument functions are controlled by BD FACSDiva™ software, this guide also contains basic software information needed for instrument setup. For detailed information on software functions, see the *BD FACSDiva Software Reference Manual*.

The *BD FACSAria Fusion User's Guide* assumes you have a working knowledge of basic Microsoft® Windows® operation. If you are not familiar with the Windows operating system, see the documentation provided with your computer.

Before using the BD FACSAria Fusion flow cytometer for the first time, review the following information:





- System Components on page 17 to become familiar with system components
- Theory of Operation on page 47 to understand how the instrument works and to learn about the software components used to control different subsystems
- Using BD FACSDiva Software on page 81 to see where software controls are located

Instructions for routine acquisition, analysis, and sorting can be found in Chapters 4 and 5.

Conventions

The following tables list conventions used throughout this guide. Table 1 lists the symbols that are used in this guide or on safety labels to alert you to a potential hazard. Text and keyboard conventions are shown in Table 2.

Table 1 Hazard symbols

Symbol ^a	Meaning
	Caution: hazard or unsafe practice that could result in material damage, data loss, minor or severe injury, or death
	Electrical danger
	Laser radiation
	Biological risk
	Pinch hazard

a. Although these symbols appear in color on the instrument, they are in black and white throughout this user's guide; their meaning remains unchanged.

Table 2 Text and keyboard conventions

Convention	Use
 Tip	Highlights features or hints that can save time and prevent difficulties
NOTE	Describes important features or instructions
<i>Italics</i>	Italics are used to highlight book titles.
Bold	Bold text indicates software elements such as windows, menus, buttons, and tabs that are used to complete tasks.

Table 2 Text and keyboard conventions (continued)

Convention	Use
>	The arrow indicates a menu choice. For example, “select File > Print” means to select Print from the File menu.
Ctrl+X	When used with key names, a plus sign means to press two keys simultaneously. For example, Ctrl+P means to hold down the Control key while pressing the letter <i>p</i> .

Technical Assistance

For technical questions or assistance in solving a problem:

- Read the section of the user’s guide specific to the operation you are performing.
- See Troubleshooting on page 253.

If additional assistance is required, contact your local BD Biosciences technical support representative or supplier.

When contacting BD Biosciences, have the following information available:

- Product name, part number, and serial number
- Any error messages
- Details of recent system performance

For instrument support from within the US, call 877.232.8995.

For support from within Canada, call 888.259.0187.

Customers outside the US and Canada, contact your local BD representative or distributor.

Limitations

This instrument is for Research Use Only. Not for use in diagnostic or therapeutic procedures.

BD Biosciences is providing software without warranty of any kind on an as-is basis. The software and workstations are intended for running the instruments supplied by BD Biosciences. It is the responsibility of the buyer/user to ensure that all added electronic files including software and transport media are virus-free. If the workstation is used for internet access or purposes other than those specified by BD Biosciences, it is the buyer/user's responsibility to install and maintain up-to-date virus protection software. BD Biosciences does not make any warranty with respect to the workstation remaining virus-free after installation. BD Biosciences is not liable for any claims related to or resulting from the buyer/user's failure to install and maintain virus protection.

System Components

The following topics are covered in this chapter:

- BD FACSAria Fusion System on page 18
- Workstation on page 19
- Biosafety Cabinet on page 20
- Flow Cytometer on page 21
- Emergency Stop Button on page 44

BD FACSAria Fusion System

The BD FACSAria Fusion flow cytometer is a high-speed fixed-alignment benchtop cell sorter. With its fixed-optics design and digital electronics, the BD FACSAria Fusion flow cytometer enables multicolor analysis of up to 18 fluorescence and two scatter options simultaneously.

The BD FACSAria Fusion system improves on BD FACSAria™ III technology with the following features:

- Higher power blue, red, and violet lasers for better multicolor performance and small particle resolution.
- Easier access to the fluidics, detectors, and electronics located in the base of the system.
- Enhanced biosafety with an optional biosafety cabinet (BSC) and integrated Aerosol Management System (AMS) that operates independently.

The system consists of three main components: the BD FACSAria Fusion, the BSC, and the workstation, as shown in Figure 1-1 on page 19.

Figure 1-1 BD FACSAria Fusion system with the BSC



Workstation

Data acquisition and analysis, as well as most BD FACSAria Fusion cytometer functions, are controlled by BD FACSDiva software on a PC workstation. The workstation includes a desktop computer, one or two monitors, and a color printer, and is equipped with the following applications:

- Microsoft® Windows® 7 operating system
- BD FACSDiva software, version 8.0 or later
 - Data acquisition and analysis
 - Automatic fluidics startup, shutdown, and cleaning modes

- Sort setup, stream monitoring, clog detection, and recovery
- BD™ Cytometer Setup and Tracking (CS&T) module for setup and tracking performance
- Supporting documentation for the software

For information about software features specific to the BD FACSAria Fusion, see Chapter 2, Theory of Operation, and Chapter 3, Using BD FACSDiva Software. For general software information, see the *BD FACSDiva Software Reference Manual*.

BD FACSDiva software version 8 includes the CS&T module version 3.0. For information on running the CS&T module with the BD FACSAria Fusion, see Checking Cytometer Performance on page 134. For information about the CS&T module, see the *BD Cytometer Setup and Tracking Application Guide*.

 **Tip** For easy access to the online *BD FACSDiva Software Reference Manual*, select **Help > Documentation > Reference Manual**.

Biosafety Cabinet

The optional BSC for the BD FACSAria Fusion has been verified to meet personnel and product protection standards for a Class II Type A2 biosafety cabinet, the National Sanitation Foundation International Standard 49, and the Australian Standard® AS 2252.2–2009. The BSC is suitable for work with Biosafety Level (BSL) 1, 2, and 3 (low to moderate risk) infectious agents.

The BSC has an integrated Aerosol Management System (AMS). See page 333 for information.

Flow Cytometer

The BD FACSAria Fusion cytometer consists of three subsystems (fluidics, optics, and electronics). The BD FACSAria Fusion cytometer is relatively compact, with a much smaller footprint than most sorters with the same capabilities. The cytometer requires only a 20-A electrical outlet and an in-house air source (or optional compressor) for the fluidics. See Figure 1-2 for a view of the BD FACSAria Fusion cytometer without the optional BSC.

Figure 1-2 BD FACSAria Fusion system without the optional BSC



See the following sections for more information on each subsystem:

- Fluidics System on page 22
- Optics System on page 35
- Cytometer Electronics on page 43

Fluidics System

The fluidics system supplies sheath and cleaning fluids, and collects waste from the cytometer. The contents of the fluidics drawer and the fluidics components located inside the cytometer make up the fluidics system.

Fluidics Drawer

The fluid containers, lines, and filters, and the connectors panel are located inside the fluidics drawer. The fluidics drawer slides out for easy access to its contents. Press down the yellow lever on the top right side of the drawer to release the lock and slide the drawer out or in.

Figure 1-3 Location of fluidics drawer and lock-release lever

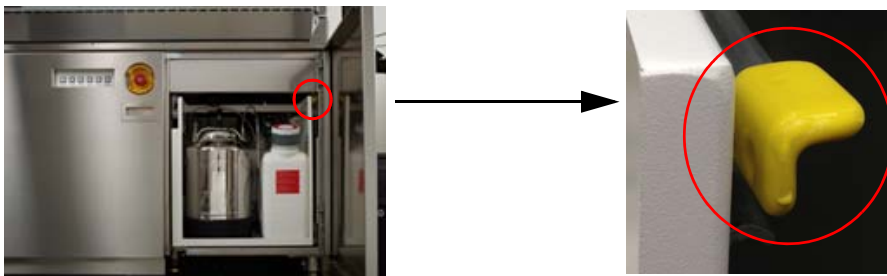

Containers

The fluidics drawer holds a 10-L stainless steel sheath tank, a 5-L stainless steel ethanol shutdown tank, a 10-L waste container, and three 5-L auxiliary cleaning fluid containers (Figure 1-4 on page 23).

Figure 1-4 Fluidics drawer containers

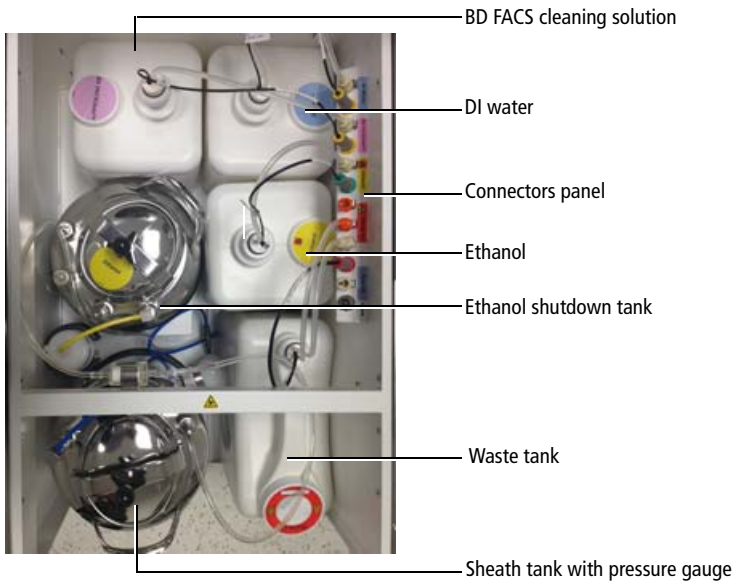

Pressure Gauge

A pressure gauge is located on the sheath fluid tank to confirm that the tank is pressurized.

Figure 1-5 Sheath pressure gauge



Fluid Filters

The fluid filters for DI water, BD FACSClean™ cleaning solution, and ethanol are located in the outside left panel of the fluidics drawer.



Connectors Panel

The connectors panel is located in the top right section of the fluidics drawer. A fluid line and a sensor connect each container to the panel.

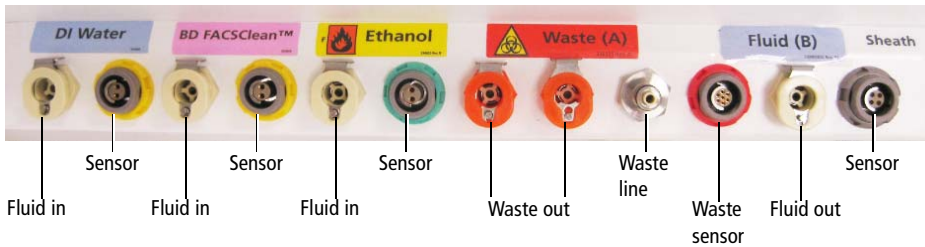

Fluidics Components

When the fluidics system is activated, the sheath fluid from the pressurized sheath tank is forced from the fluidics drawer up into the cuvette flow cell where hydrodynamic focusing forces particles from the sample injection chamber through the cuvette in a single-file stream.

Within the cuvette flow cell, laser light is focused on the sample core stream. Fluorescent molecules excited by the different laser wavelengths are detected by the optics and analyzed by the electronics. Particles are then either transported to waste reservoirs via the waste aspirator, or sorted into a collection device within the sort collection chamber.

The following fluidics components are described in this section. For more information about fluidics, see Fluid Movement on page 48.

- Sample Injection Chamber on page 26
- Tube Holders on page 28
- Cuvette Flow Cell on page 28
- Integrated Nozzle on page 29
- Sort Block on page 30
- Sort Collection Chamber on page 34

Figure 1-6 Overview of the flow cell region

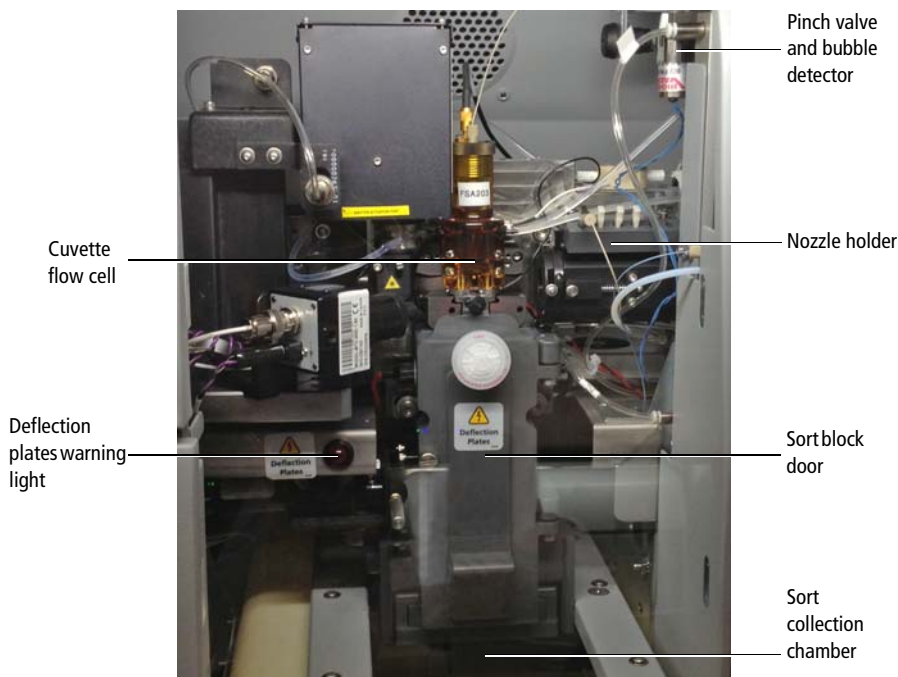

Sample Injection Chamber

The sample injection chamber is where sample is introduced into the flow cytometer. During acquisition, the chamber is pressurized to force sample toward the cuvette flow cell.

Samples can be agitated and temperature-controlled within the sample injection chamber using controls in the software (see Fluidics Controls on page 83). You can view the amount of fluid remaining in your sample tube by pressing the chamber light button shown in Figure 1-7.



Do not use the chamber light for long periods with samples stained with light-sensitive reagents.

Figure 1-7 Sample injection chamber

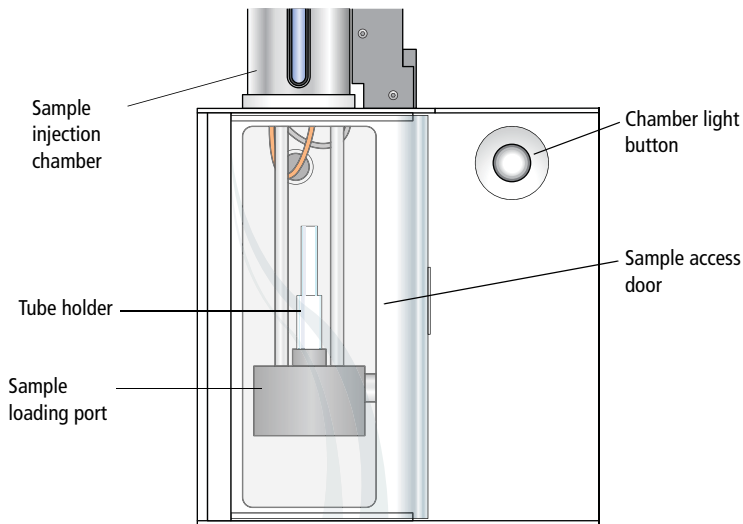

Bubble Detector

The bubble detector is an optical sensor that detects air bubbles from the sample tube. Located on the sample line just before the pinch valve, it triggers the pinch valve to close, cutting off sample flow and preventing bubbles from entering the flow cell. When a bubble is detected, the bulk injection chamber light and LED in the button blink to alert the operator.

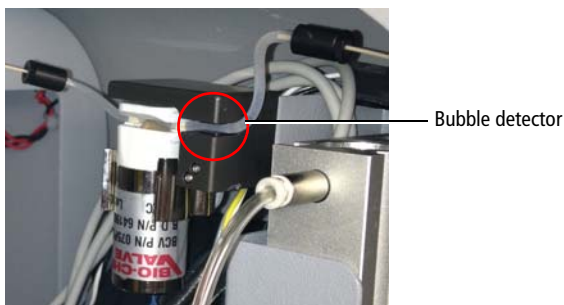

Tube Holders

A variety of tube holders are provided with the cytometer to accommodate tubes from 15-mL centrifuge tubes to 1.0-mL microtubes (Figure 1-8).

To load a tube, install the appropriate-size tube holder onto the loading port, and place a tube in the holder. Make sure to press the tube holder down firmly onto the metal rod in the loading port, so the tube holder is seated correctly each time a tube is installed.

When the Load button is clicked in the software (see Acquisition Controls on page 100), the loading port rises to enclose the tube within the chamber. The chamber is then pressurized so that sample will flow to the flow cell.

Figure 1-8 Tube holders

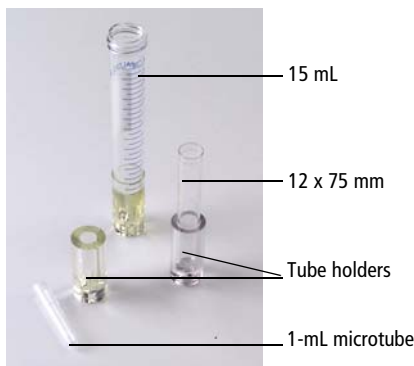

After a tube is loaded, the Load button changes to Unload. Click the Unload button to lower the loading port after data has been recorded. After each tube is unloaded, sheath fluid flushes the sample tubing inside and out to reduce potential sample carryover.



To prevent injury from moving parts, keep your hands and clothing away from the loading port when a tube is loading or unloading. Do not place objects under the loading port.

Cuvette Flow Cell. The BD FACSAria Fusion system includes a next-generation flow cell that has been optimized for four laser beam spots. The cuvette flow cell is the heart of the BD FACSAria Fusion cytometer (Figure 1-9). Within the flow

cell, hydrodynamic focusing forces particles through the cuvette in a single-file stream, where laser light intercepts the stream at the sample interrogation point.

Figure 1-9 Cuvette flow cell

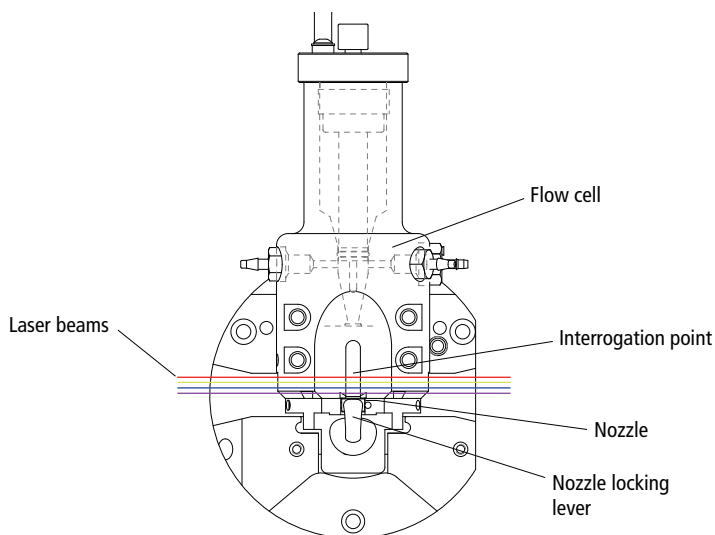

The unique flow cell design permits particles to flow through the cuvette at a low velocity (approximately 6 meters per second for the 70-micron sort setup), allowing longer exposure to laser energy. The cuvette is gel-coupled to the fluorescence objective lens to transmit the greatest amount of emitted light from the interrogation point to the collection optics (see Optics System on page 35). After passing through the cuvette, the stream is accelerated (to approximately 30 meters per second with the 70-micron sort setup) as it enters the nozzle tip, where the drop drive breaks the stream into droplets for sorting.

Integrated Nozzle

The BD FACSAria Fusion next-generation flow cell requires integrated nozzles that have been optimized for it.

The integrated nozzles are available in four sizes (70, 85, 100, and an optional 130 μm) to accommodate a variety of particle sizes, plus a closed-loop nozzle for use in cleaning and shutdown procedures. The nozzle is keyed to a fixed position

at the lower end of the cuvette. Because the nozzle is below the interrogation point, optical alignment is not affected when the nozzle is changed.

Figure 1-10 Integrated nozzle

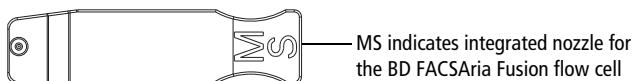

Bottom view of nozzle

See these sections for more information on the nozzle:

- Changing the Integrated Nozzle on page 231
- Cleaning the Integrated Nozzle on page 233
- Handling the Integrated Nozzle on page 235

Sort Block

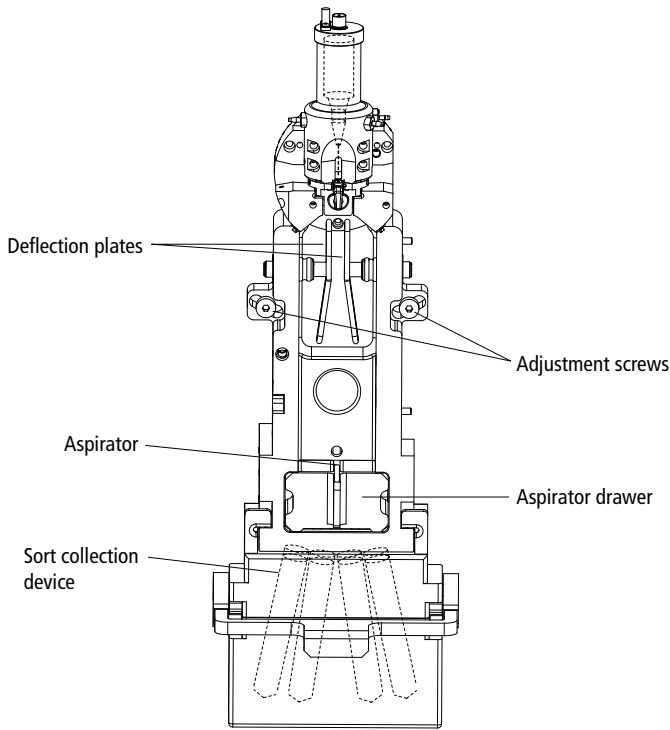

After leaving the nozzle, particles pass through the sort block where they are either transported to waste via the waste aspirator, or sorted into a collection device in the sort collection chamber. The sort block houses the high-voltage deflection plates, along with the aspirator and aspirator drawer (Figure 1-11 on page 31).

Figure 1-11 Sort block with door open



Note that the entire sort block assembly can be rotated on a fixed pivot point to adjust the position of the stream in the waste aspirator. If the keyed stream position differs between different nozzles, the stream might not hit the center of the aspirator after the nozzle is changed. In this case, you can change the angle of the sort block by loosening the adjustment screws on both sides of the deflection plates and rotating the sort block. An Allen wrench is provided in the accessory kit. Tighten the screws when the stream is re-centered in the aspirator.

Deflection Plates. The high-voltage deflection plates are used to deflect side streams during sorting. The plates are turned on and off using the Voltage control in the Side Stream window (see Side Stream Formation on page 69). A red warning light is illuminated whenever the plate voltage is on (Figure 1-13 on page 33).

  A 12,000-volt potential exists between the deflection plates when they are on. Contact with the charged plates results in serious electrical shock. Do not touch the deflection plates when the voltage warning light is illuminated, or when the software indicates that the plate voltage is on. The plates remain energized even when the sort block door is open.

Aspirator Drawer. The aspirator drawer keeps the sort collection tubes covered until sorting begins (Figure 1-12). You can open and close the drawer using a control in the Sort Layout or Side Stream window (see Using Sorting Controls on page 109). When the Sweet Spot is on and a clog is detected during sorting, the drawer automatically closes to protect the sort collection tubes. For information on how to handle a clog, see Responding to a Nozzle Clog During a Sort on page 190.

 To avoid pinching your hands or fingers in the drawer, keep your hands away from the sort block during sorting.

Figure 1-12 Aspirator drawer closed (left) vs open (right)



Aerosol Management . During sample acquisition and sorting, the sort block door and flow cell access door should be kept closed to help contain potential aerosols (Figure 1-13 on page 33).

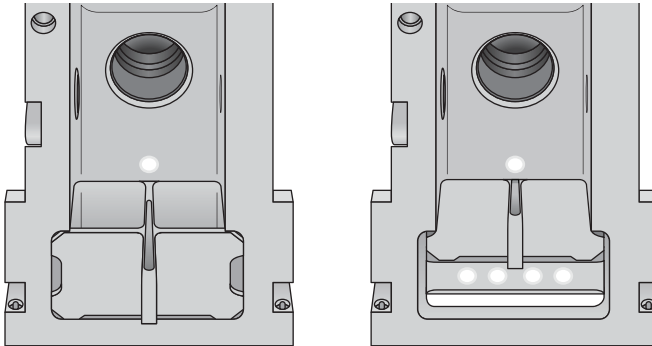

Cell sorters that use droplet generation methods, such as the BD FACSAria Fusion, can produce aerosols around the sample stream. When acquiring biohazardous samples, follow universal precautions at all times. Keep the sort block door closed during sorting. If you need to access the sort block and you are working with highly infectious samples, consider turning off the stream before opening the sort block door.

Figure 1-13 Sort block with door closed

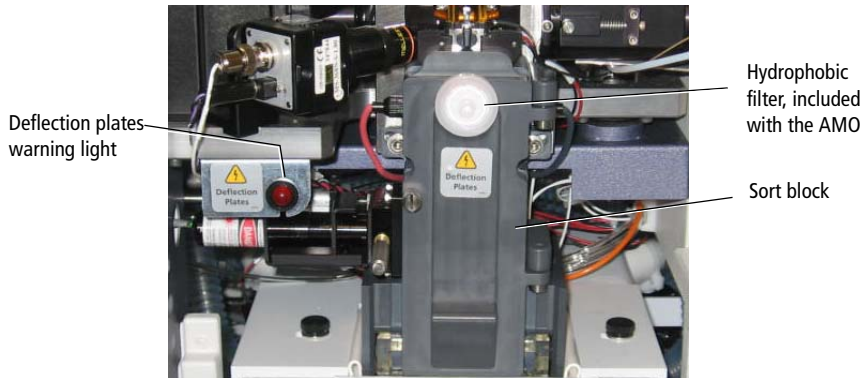

Additional aerosol removal is provided by either the AMS or the BD™ Aerosol Management Option (AMO).

The AMS is integrated into the BSC and contains a high efficiency particulate air (HEPA) filter. See *Operating the AMS* on page 335 for instructions.

The AMO is an optional device for systems without a BSC. The AMO evacuates the sort collection chamber during sorting and is equipped with an ultra-low penetrating air (ULPA) filter to trap aerosolized particles. See *Chapter 10, BD Aerosol Management Option* on page 303 for complete information on using this option.

Sort Collection Chamber

Collection devices are installed in the sort collection chamber to collect sorted samples. The collection devices are designed in two pieces with a universal top that can be used with different tube configurations. The universal top has three holes on the back side that help with aerosol evacuation when an AMO or AMS is installed. Figure 1-14 shows the types of collection devices that are available.

Figure 1-14 Sort collection devices

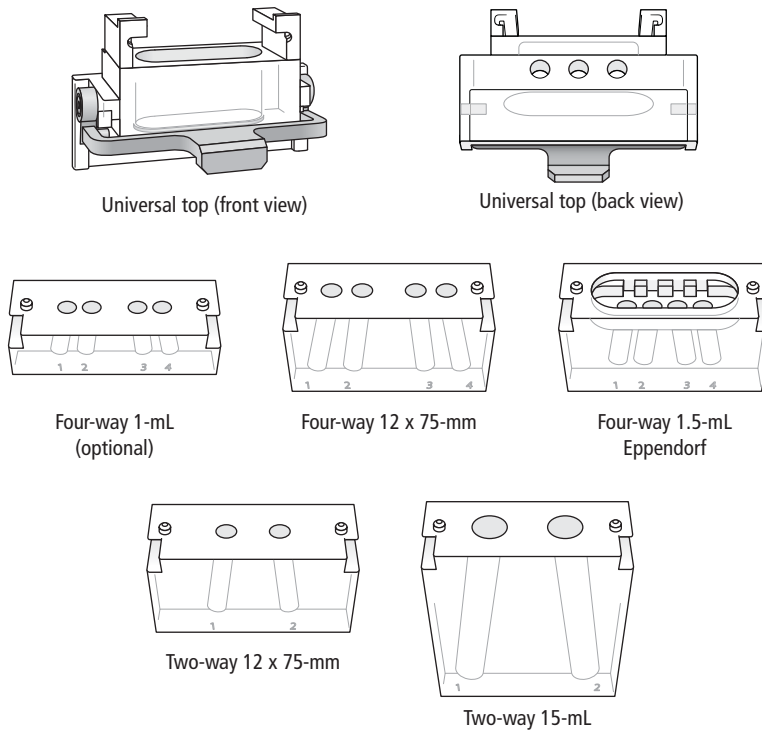

An automated cell deposition unit (ACDU) that sorts into multiwell plates and onto microscope slides is available as an option. See Figure 1-15 on page 35. BD Biosciences also offers a temperature control option to maintain the temperature of sorted samples during sorting. See Temperature Control Option on page 345.

The sort collection chamber door should be kept closed when sorting onto a plate. The door keeps the chamber free of dust and other airborne particles, and seals the chamber during aerosol evacuation for cytometers equipped with the AMO.

Figure 1-15 Plate Loader on ACDU



Optics System

The BD FACSAria Fusion cytometer uses innovative designs for both the excitation and collection optics. For detailed optics specifications, see Chapter 9, Laser Options on page 285.

Excitation Optics

The excitation optics consist of lasers, fiber optic cables, beam-shaping prisms, and an achromatic focusing lens, as shown on the X-mount optical plate (Figure on page 36).

Figure 1-16 X-mount optical plate



For information about how signals are generated, see Signal Generation on page 52.

The BD FACSAria Fusion cytometer uses air-cooled and solid state lasers that do not have special power or cooling requirements.

The system also supports up to six installed lasers, of which only four can be used at once.

See Table 1-1 for the laser choices. See Laser Options on page 285 for laser specifications.

Table 1-1 Laser configurations

Laser	Wavelength (nm)	Comments
Red	640	Standard
Yellow-Green	561	Optional
Blue	488	Standard
Blue-Violet	445	Optional Shares the blue-laser optics. See Laser Options on page 285.

Table 1-1 Laser configurations

Laser	Wavelength (nm)	Comments
Violet	405	Optional
Near UV	375	Optional Shares the violet-laser optics. See Laser Options on page 285.



Lasers emit intense, coherent electromagnetic radiation that can cause irreparable damage to skin and eyes. To prevent retinal burns and possible blindness, do not remove laser shielding, adjust laser controls, or attempt to service the cytometer any place where laser warning labels are attached. See the *BD FACSAria Fusion Safety and Limitations Guide* for the placement of laser warning labels.

Fiber optics direct the laser light in a precise and constant manner onto beam-shaping prisms, which in turn transmit the laser light to a focusing lens. The lens focuses the laser light onto the sample core stream within the cuvette flow cell (Figure 1-9). The lasers are positioned on the sample stream for optimal generation of signals. Since the optical pathway and sample core stream are fixed, optimization is constant from day to day.

X-Mount Optical Plate

The fiber optic heads for all existing lasers (except the 375-nm laser) are mounted on an X-mount optical plate. Figure 1-17 on page 38 shows the location for each fiber optic head.

The 488-nm and the 445-nm lasers share the same beam spot, so only one of them can be used at a time. Similarly, the 375-nm and 405-nm lasers share a beam spot and only one of them can be used at a time.

Figure 1-17 The X-mount optical plate laser configuration

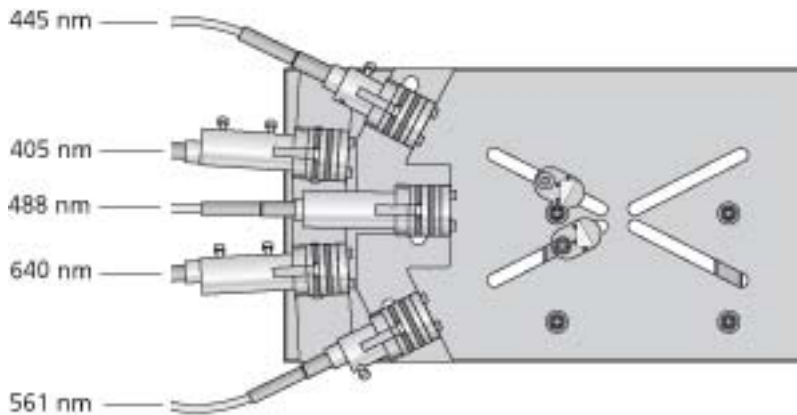

375-nm Laser

The 375-nm laser option features a solid state laser that also excites fluorochromes and dyes. It is also useful for side population studies. It uses the same emission pathways as the violet laser option. The laser alignment is fixed and requires no adjustments once it is installed.

The 375-nm laser is the only laser not mounted on the X-mount optical plate. It is mounted next to the flow cell as shown in the Figure 1-18.

Figure 1-18 The 375-nm laser

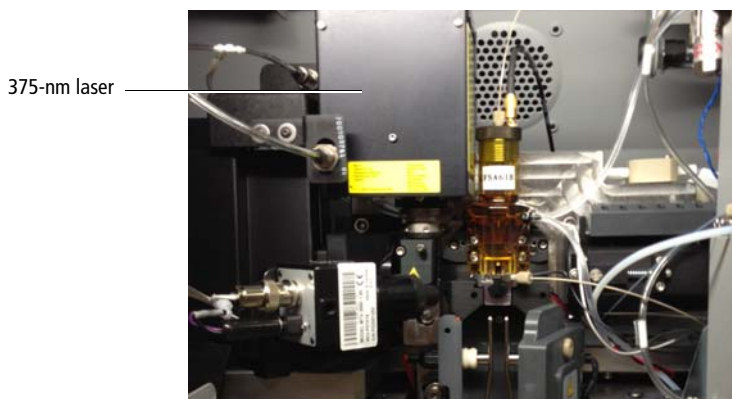

Collection Optics

From the cuvette flow cell, laser light is collected by a fluorescence objective lens that is gel-coupled to the cuvette to transmit the maximum amount of light. The lens collects and focuses fluorescent light emitted at each of the laser focal points onto individual collection fibers. These fibers transfer the emitted light to the collection optics, as shown in Figure 1-19.

Figure 1-19 Side view of flow cell, nozzle, and objective lens

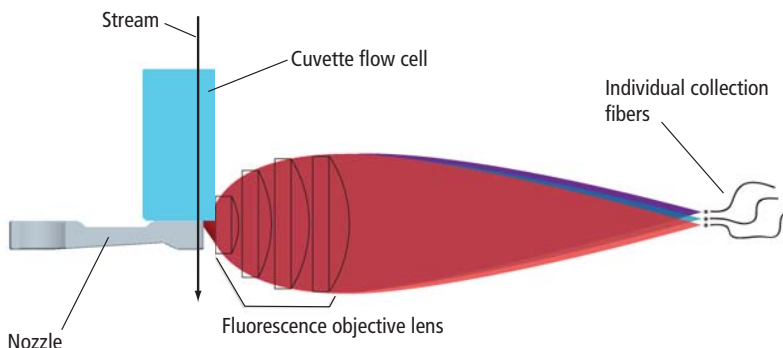

The collection optics are set up in octagon-shaped arrays that are engineered to maximize signal detection from each laser. This is accomplished by transmitting the highest wavelengths to the first photomultiplier tube (PMT), and reflecting lower wavelengths to the next PMT through a series of longpass dichroic mirrors. Bandpass filters in front of each PMT allow fine-tuning of the spectral wavelengths that need to be collected. Since reflection is more efficient than transmission, this design greatly increases the multicolor detection capabilities of the cytometer. See Figure 1-20 on page 40.

Figure 1-20 Transmission pathways in an octagon

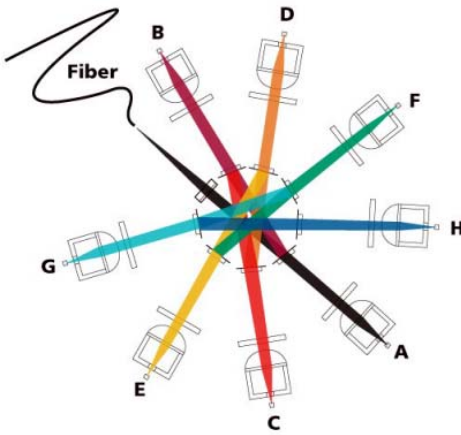

Detectors

BD FACSAria Fusion systems can be configured with up to six lasers, with four active at one time. For complete information about laser options, mirrors, filters, and fluorochromes required for each laser, see Laser Options on page 285.

The following figure shows the locations of detector arrays in a 6-laser system.

Figure 1-21 Six-laser system with four octagons

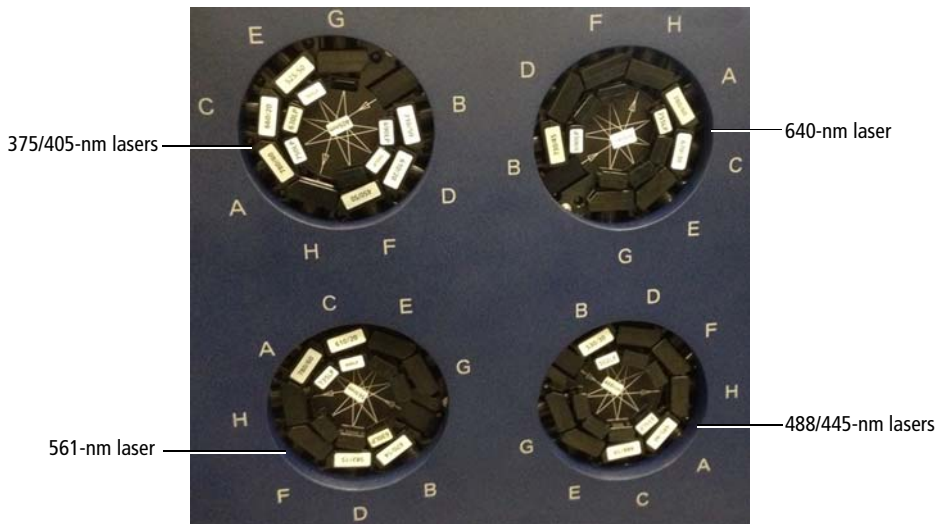

Laser Power Panel

The laser power panel is located above and to the right of the laser octagons. Pressing a laser button powers up the corresponding laser. The laser button lights up when the laser is on. Depending on how your system is configured, you can choose different combinations of lasers by pressing the corresponding button in the laser power panel. For more information, see Excitation Optics on page 35.



Stream-Viewing Optics

The BD FACSAria Fusion cytometer is equipped with optical components that are used to view the stream (Figure 1-22).

- The upper camera generates an image used to monitor drop formation. It is focused on the stream, just below the nozzle, to provide an image of the drop breakoff.
- The lower camera generates an image used for the BD FACST[™] Accudrop option. It enhances the ability to see the side streams and assists in setting an accurate drop-delay value.

Figure 1-22 Stream-viewing optics

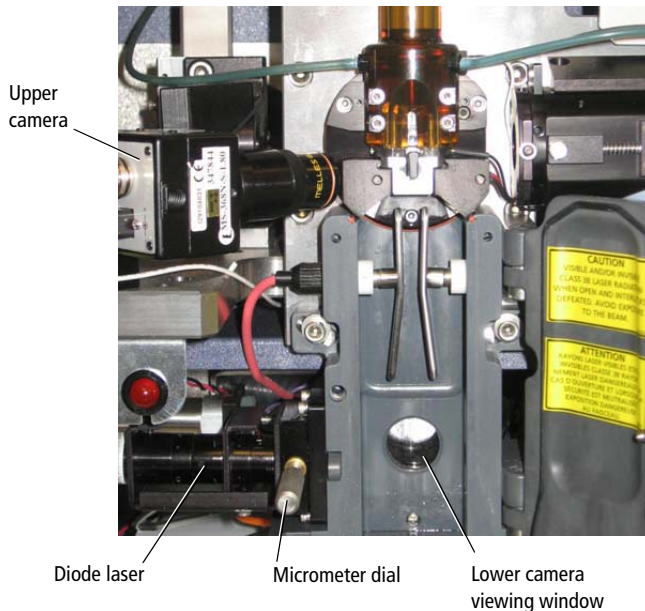

Special image-processing software allows you to view the stream images from each camera within separate windows in BD FACSDiva software. See Sorting on page 64 for more information about viewing the streams and to learn how Accudrop components are used to determine the drop delay.

Cytometer Electronics

The electronic components consist of the power and air supply panels along with processing boards in the card cage. The power and air supply panels are located on the right side of the cytometer base in the lower left corner. Other electronic components are embedded within the cytometer and do not need adjustment. This section describes only adjustable cytometer electronics. For more information about the electronics, see Signal Detection on page 54.

Power and Operation

Power to the BD FACSAria Fusion is supplied by a power cord plugged directly into a standard electrical outlet. The optional BSC is hard-wired to the in-house electrical system.

Power Panel

The power panel contains the power button, a USB port for BD service, an ethernet connection, connectors for the stream-viewing cameras, and a serial communications cable (Figure 1-23).

Figure 1-23 Power panel

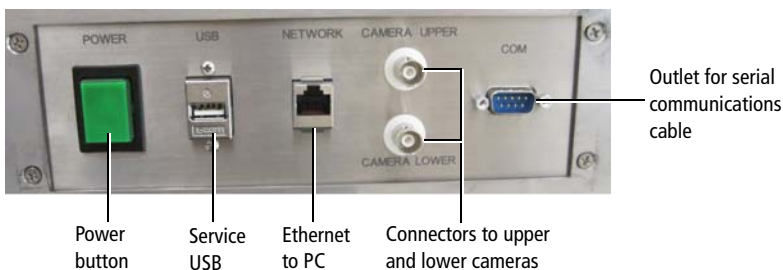

Air Supply Panel

The air supply panel (Figure 1-24 on page 44) is located to the right of the power panel. The air supply panel contains the external air regulator, air pressure gauge, power cord, external air input connector, and the cytometer circuit breaker. Air pressure is adjusted using BD FACSDiva software.

Figure 1-24 Air supply panel

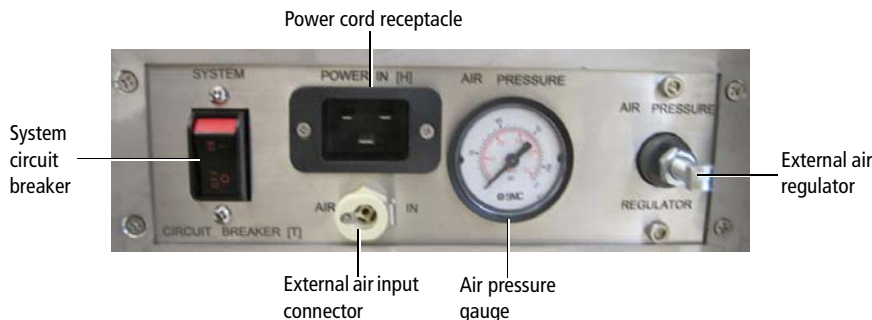

Connecting to the External Air Supply

The BD FACSAria Fusion system requires an external (in-house) air source or optional compressor to operate.

To connect the fluidics to the external air supply, switch on the external air, if necessary. Attach the external air line to the external air input connector (Figure 1-24). The external air supply must provide 6.6–6.9 Bar (95–100 PSI) regulated. The source of the compressed air must deliver clean (<5 ppm) dry-filtered (oil-free) air at stable pressures.

Emergency Stop Button

The emergency stop button (Figure 1-25 on page 45) is a safety feature that can be used to stop the movement of the loading port and ACPU stage. The emergency stop button is located on the front of the optics drawer. The button lights up when a tube is loading to remind you to keep your hands away from the loading port.

Figure 1-25 Emergency stop button



The following occur when this button is pushed:

- The tube is unloaded from the sample injection chamber.
- The ACDU stage (if in use) stops moving.
- The stream is turned off.
- The deflection plate voltage is turned off.
- The aspirator drawer (if open) closes to protect the sort collection tubes.
- A warning message is displayed on the screen.

NOTE The emergency stop button does not turn off the lasers or shut down the cytometer main power.

Do not reset the button until the message is displayed. To reset the button, slowly turn the button clockwise until the light turns off and the button returns to its original position.

THIS PAGE INTENTIONALLY LEFT BLANK

2

Theory of Operation

This chapter describes how the BD FACSAria Fusion cytometer works and how BD FACSDiva software controls are used to operate different system components. For a general overview of the software, see Using BD FACSDiva Software on page 81.

See the following sections for a description of these BD FACSAria Fusion functions:

- Fluid Movement on page 48
- Signal Generation on page 52
- Signal Detection on page 54
- Sorting on page 64

Fluid Movement

The fluidics system is responsible for moving particles from the sample injection chamber through the cuvette flow cell for interrogation, and then to waste or into a collection device during sorting (Figure 2-1). The following sections describe the controls used to move fluids through the BD FACSAria Fusion fluidics system.

Figure 2-1 Fluid movement through the fluidics system

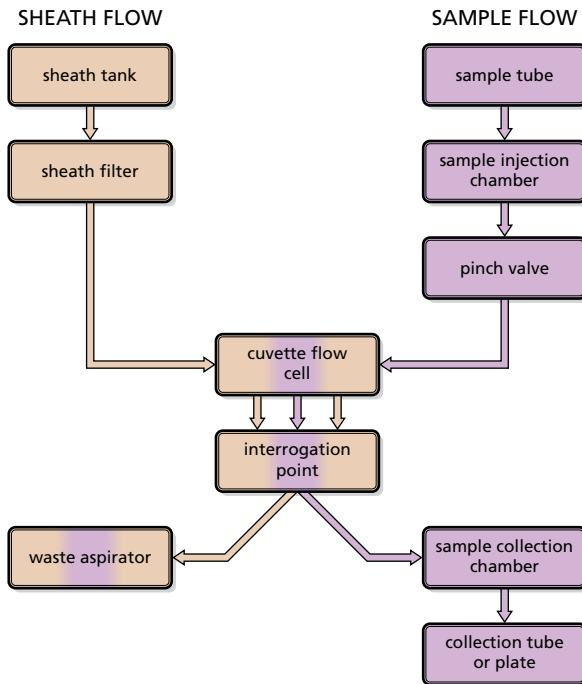

Sheath Flow

When you turn on the cytometer, the main air compressor starts up. The fluidics system is activated when you select the Fluidics Startup command in BD FACSDiva software. During fluidics startup, sheath fluid is forced from the pressurized sheath tank through a filter and is delivered to the cuvette flow cell at a constant pressure. You can view the current sheath pressure setting by selecting Cytometer > Sheath Pressure (Figure 2-2).

Figure 2-2 Sheath pressure level

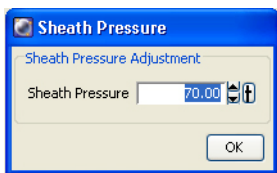

After fluidics startup, sheath flow is controlled using the Stream button in the Breakoff window (Figure 2-3). When clicked, the button changes from a red "X" to a green check mark, and sheath flows through the cuvette flow cell at the rate that is specified in the Sheath Pressure dialog. (See Drop Formation on page 65 for a complete description of the Breakoff window.)

Figure 2-3 Stream control in Breakoff window

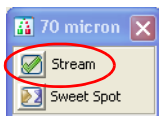

As a general rule, the sheath pressure level is set by selecting a sort setup mode from the Sort menu, rather than by adjusting the sheath pressure control. Each sort setup mode is optimized at a preset sheath pressure. If you change the sheath pressure, a multitude of other values will be affected and need updating, including the drop-drive frequency, drop-delay value, laser delay, area scaling factor, and other values. For more information, see Sort Setup on page 103.

Sample Flow

Sample is introduced into the cuvette when the Load button is clicked on the Acquisition Dashboard (Figure 2-4). After Load is clicked, the loading port rises to enclose the tube within the sample injection chamber. The chamber is automatically pressurized and the chamber pressure forces sample through the sample line into the cuvette flow cell. To stop sample flow after a tube is loaded, click the Stop Acquiring button.

The sample flow rate is specified using the Flow Rate field on the Acquisition Dashboard. You can adjust the flow rate from 1–11, which corresponds to approximately 10–80 $\mu\text{L}/\text{minute}$.

Figure 2-4 Load button and Flow Rate field on the Acquisition Dashboard

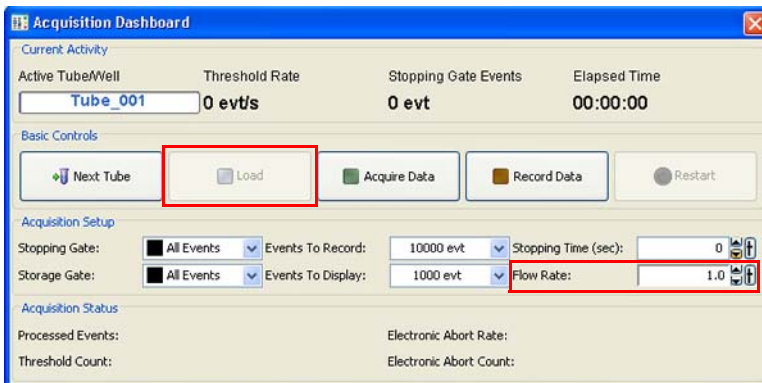

Note that the relatively longer sample tubing on the BD FACSAria Fusion cytometer results in a different flow rate between cells and beads. Thus, absolute counting using BD Trucount™ beads can yield erroneous results.

Hydrodynamic Focusing

In the flow cell, pressurized sheath fluid surrounds the sample fluid to hydrodynamically focus the core stream of suspended cells into the center of the cuvette, where the particles are intercepted by the laser beam.

The difference in pressure between the sheath fluid and the sample fluid can be used to vary the diameter of the sample core. A lower difference results in a relatively narrow core stream, while a higher difference results in a wider sample stream.

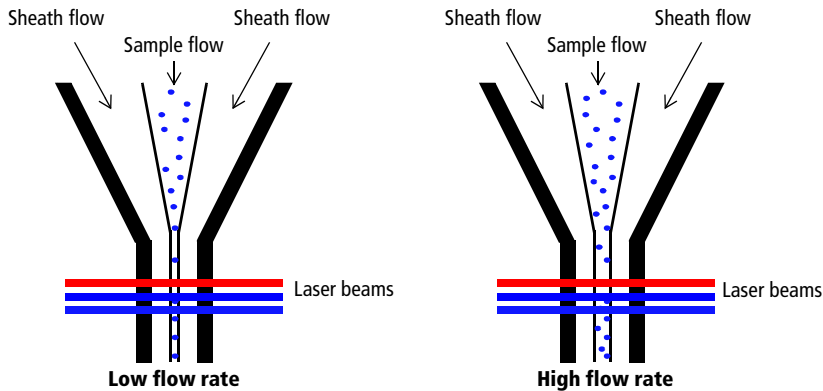

Ideally, you want the core stream at its minimum diameter so that cells pass through the laser beam in a single-file stream. However, depending on your application, a lower resolution might be acceptable in order to acquire the data more quickly. For example, with this three-laser configuration, a higher flow rate is generally used for qualitative measurements such as immunophenotyping—the data is less resolved but is acquired more quickly. A lower flow rate is generally used in applications for which greater resolution is critical.

Signal Generation

The following sections describe how signals are generated when cells or particles intercept the laser within the cuvette flow cell.

Light Scatter

When a cell or particle passes through a focused laser beam, laser light is scattered in all directions. Light that scatters axial to the laser beam is called forward scatter (FSC). Light that scatters perpendicular to the laser beam is called side scatter (SSC). FSC and SSC are related to certain physical properties of cells:

- FSC indicates relative differences in the size of the cells or particles.
- SSC indicates relative differences in the internal complexity or granularity of the cells or particles.

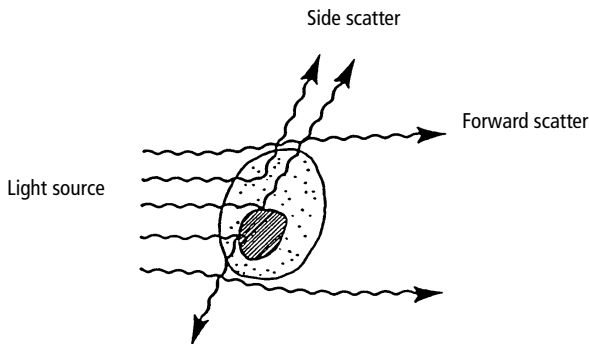

Fluorescence Signals

When cells or particles stained with fluorochrome-conjugated antibodies or other dyes pass through a laser beam, the dyes can absorb photons (energy) and be promoted to an excited electronic state. In returning to their ground state, the dyes release energy, most of which is emitted as light. This light emission is known as fluorescence.

Fluorescence is always a longer wavelength (lower-energy photon) than the excitation wavelength. The difference between the excitation wavelength and the emission wavelength is known as the Stokes shift. Some fluorescent compounds such as PerCP exhibit a large Stokes shift, absorbing blue light (488 nm) and emitting red light (675 nm), while other fluorochromes such as FITC have a smaller Stokes shift, absorbing blue light and emitting green light (530 nm).

The emission spectra for some commonly used fluorochromes are shown in Figure 2-5.

Figure 2-5 Emission spectra of commonly used fluorochromes

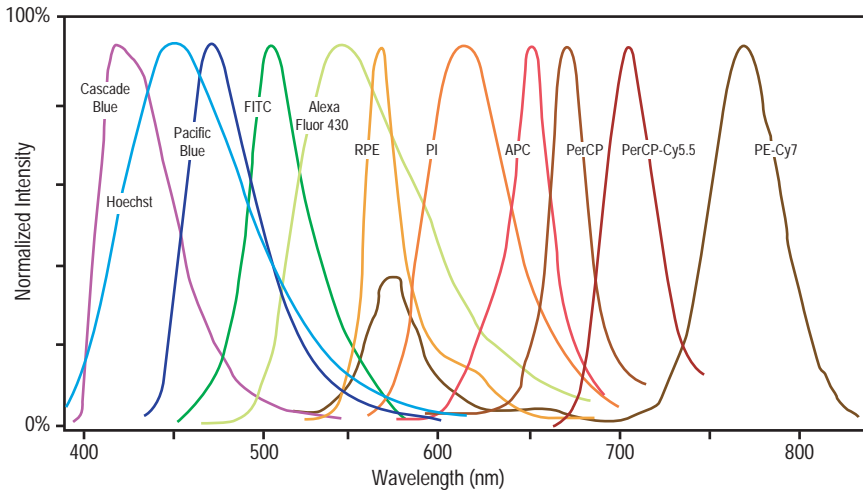

Signal Detection

From the cuvette flow cell, scattered and fluorescent light is collected by the fluorescence objective lens. The lens collects and focuses fluorescent light emitted at each of the laser focal points onto individual collection fibers. These fibers transfer the emitted light to the individual detector arrays.

The following sections describe how laser light is detected and translated into signals that can be displayed in a plot.

Detector Arrays

The BD FACSAria Fusion has four octagon detector arrays. Each detector array houses dichroic and bandpass filters, which steer and filter the emitted light, and PMTs, which detect light signals.

In the configuration shown in Figure 2-6, the top left octagon detects fluorescence signals excited by the 405-nm (violet) laser. The top right octagon detects fluorescence signals excited by the 640-nm (red) laser. The bottom right octagon detects SSC and up to seven fluorescence signals excited by the 488-nm (blue) laser. Each octagon can detect up to eight fluorescence channels. (An optical upgrade is required to fill all detection channels.)

Figure 2-6 3-laser system with three octagons

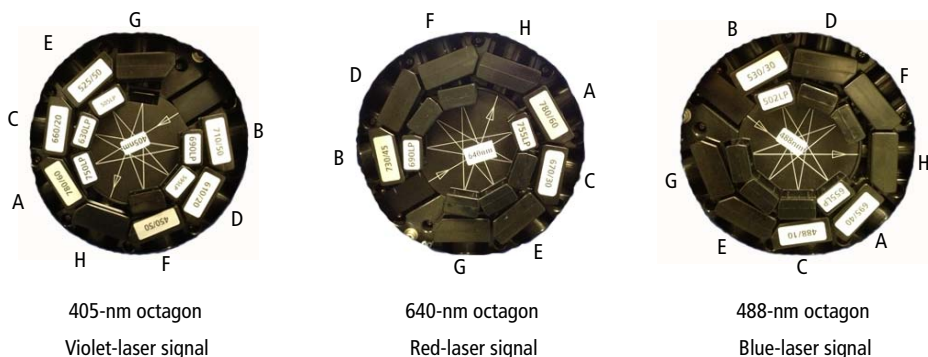

Filters

Optical filters modify the spectral distribution of light scatter and fluorescence directed to the detectors. Three kinds of filters are used in the detector arrays. Longpass (LP) filters are used to steer light between the detectors within a detector array, while bandpass (BP) and neutral density (ND) filters allow fine-tuning of the spectral wavelengths that need to be collected (Figure 2-7).

Figure 2-7 Detectors and filters in an octagon array

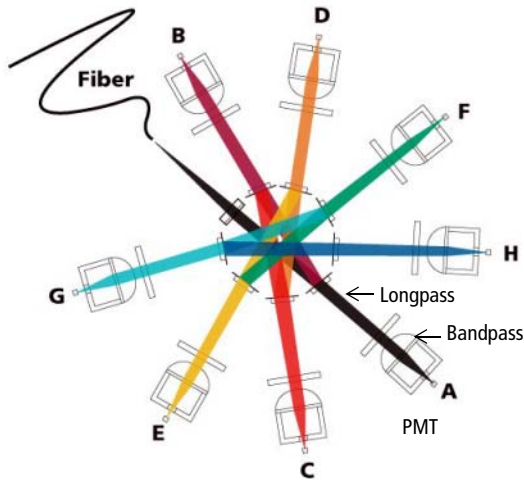

Longpass Filters

LP filters pass wavelengths longer than the filter rating and reflect shorter wavelengths. For example, a 500 LP filter permits wavelengths longer than 500 nm to pass through it and reflects wavelengths shorter than 500 nm (Figure 2-8).

Figure 2-8 Light reflection by longpass filter

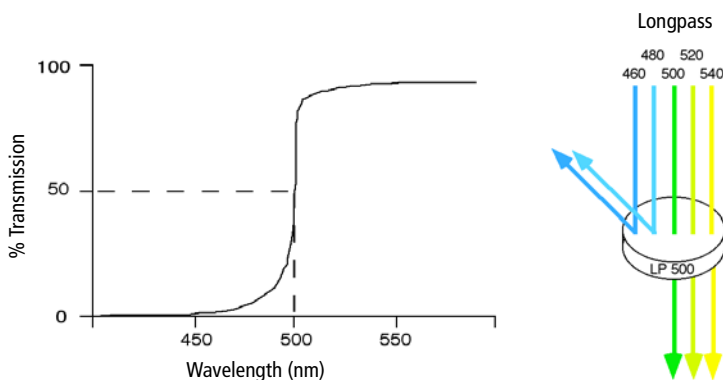

Dichroic filters that are used to direct different color light signals to different detectors are called dichroic mirrors or beam splitters.

Although dichroic mirrors have the properties of LP optical filters, you cannot necessarily use any type of LP filter as a beam splitter. A beam splitter must have a surface coating that reflects certain wavelengths, but many types of LP filters are absorbance filters that do not have any specific reflective characteristics. Also, optical filters and beam splitters are rated at a specific angle of incidence. When used as a beam splitter, they are placed at an angle relative to the light source. Their optical properties are therefore designed for that angle of incidence.

The detector arrays use LP dichroic mirrors to steer progressively shorter wavelengths of light to the next PMT in the array. For example, in the octagon array, light first passes through a 735 LP filter in the A position, followed by a 655 LP filter in the B position. Thus, wavelengths longer than 735 nm are detected at PMT-A. All wavelengths <735 nm are reflected to PMT-B. Wavelengths between 655 nm and 735 nm are detected at PMT-B. All wavelengths <655 nm are reflected to PMT-C, and so on. For a list of the longpass filters used in the detector arrays, see Laser Options on page 285.

Bandpass Filters

BP filters transmit a relatively narrow range or band of light. Bandpass filters are typically designated by two numbers. The first number indicates the center wavelength and the second refers to the width of the band of light that is passed. For example, a 500/50 BP filter transmits light that is centered at 500 nm and has a total bandwidth of 50 nm. Therefore, this filter transmits light between 475 and 525 nm (Figure 2-9).

Figure 2-9 Light transmittance by bandpass filters

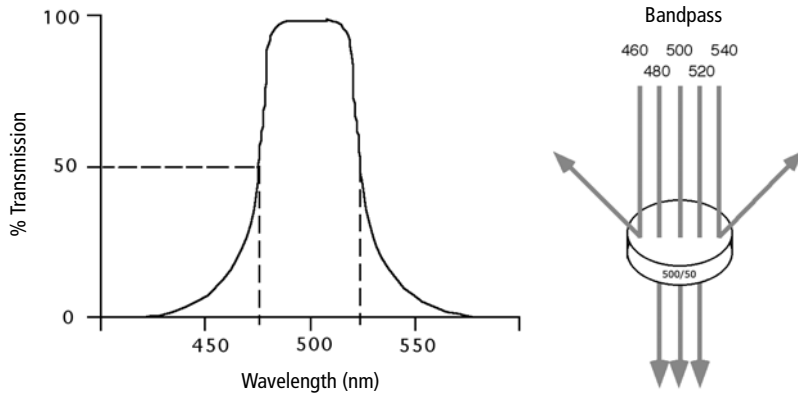

Discriminating (DF) filters have the same general function—they transmit a relatively narrow band of light. The principal difference between BP and DF filters is their construction. DF filters have more cavities or layers of optical coatings, resulting in a steeper transmission curve than the curve for a BP filter. This steep slope means that a DF filter is better at blocking light outside the rated bandwidth of the filter. See Figure 2-10 on page 58.

Figure 2-10 Bandpass (BP) vs discriminating (DF) filters

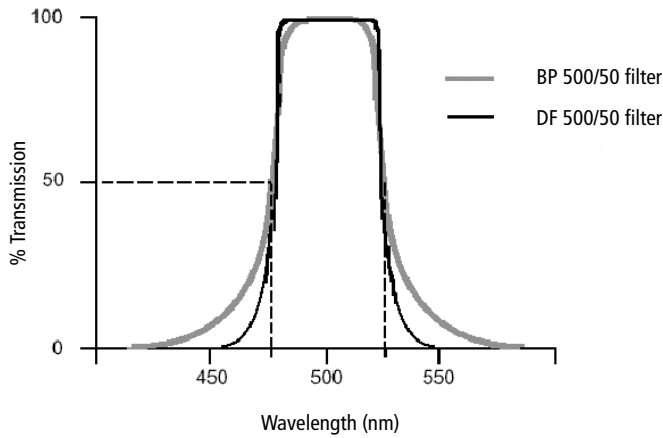

In the detector arrays, DF filters block high-intensity laser light and filter the remaining light to ensure that only the required wavelengths reach their intended detector. For example, in the octagon array, PMT-A has a 780/60 DF filter in front of it, which transmits light of 750–810 nm. Thus, the only wavelengths that will reach the A detector are those between 750 and 810 nm.

For optimal detection of fluorescent light, a bandpass filter must always be installed in front of each detector. For a list of the bandpass filters used in the detector arrays, see Laser Options on page 285.

Neutral Density Filters

ND filters transmit a fixed percentage of light, reducing the transmitted intensity of all wavelengths equally. ND filters are neutral with respect to wavelength.

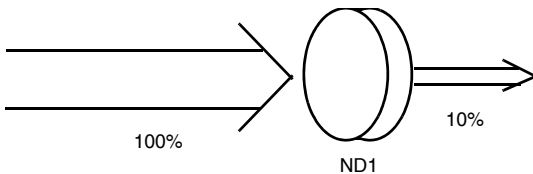

The ND1.5 filter on the BD FACSAria Fusion allows approximately 15% of the light to be transmitted. The FSC detector has an ND filter placed in front of the 488/10 BP filter. The percentage of light needed for detection is based on particle size. For applications involving small particles (for example, bacteria or platelets), you might need to remove the FSC ND filter. For applications involving large particles for which events appear off scale on the FSC axis with a gain of zero, a higher value ND filter is needed to decrease the FSC signal and keep the events on scale.

The system comes with three ND filters: 1.0, 1.5, and 2.0. See *Removing or Installing the FSC ND Filter* on page 251.

Detectors

Detectors within each detector array convert light signals into electrical signals that can be processed by the electronics system.

There are two types of signal detectors in the BD FACSAria Fusion flow cytometer: the photodiode and PMTs. The photodiode is less sensitive to light signals than the PMTs, and is used to detect the stronger FSC signal. The photodiode detects FSC light from the blue laser, and is stored outside the detector arrays. PMTs are used to detect the weaker signals generated by SSC and all fluorescence channels. Each octagon can hold up to eight PMTs.

Each PMT detects only one fluorochrome at a time. In BD FACSDiva software, the Cytometer Configuration window lets you define which fluorochromes or cell parameters will be measured at each PMT detector. If more than one fluorochrome is measured using the same PMT, you can add additional parameters to your configuration and select the appropriate fluorochrome within your software experiment. See *Cytometer Configuration* on page 87 for more information.

Figure 2-11 Example BD FACSAria Fusion cytometer configuration

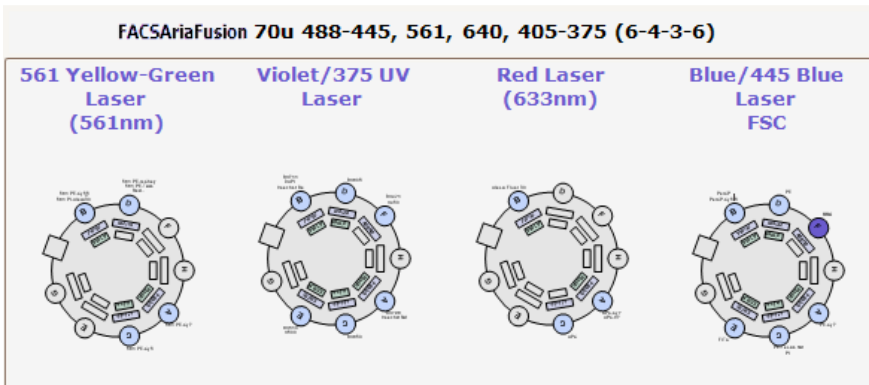

Electronic Processing

As cells or other particles pass through the focused laser beams, they scatter the laser light and can emit fluorescence. Because each laser beam is focused on a small spot and particles move rapidly through the flow cell, the scatter or fluorescence emission has a very brief duration—only a few microseconds. The PMTs convert this brief flash of light into an electrical signal called a pulse (Figure 2-12).

Figure 2-12 Anatomy of a pulse

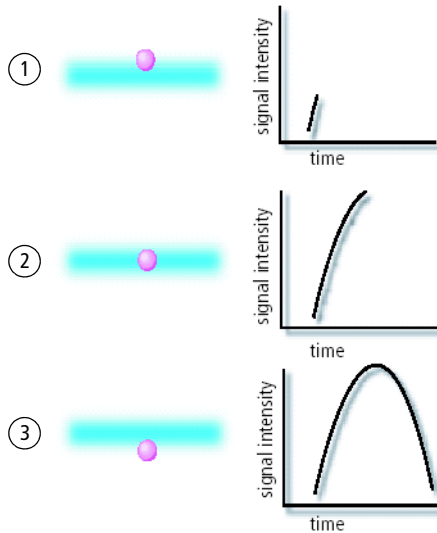

No.	Description
1	A pulse begins when a particle enters the laser beam. At this point, both the beam intensity and signal intensity are low.
2	The pulse reaches a maximum intensity or height when the particle reaches the middle of the beam, where the beam and signal intensity are the brightest. The peak intensity, or height of the pulse, is measured at this point.
3	As the particle leaves the beam, the pulse trails off.

Pulse Parameters

A parameter is a pulse property that is generated by a single PMT or photodiode, measuring fluorescent or scattered light. You can measure three characteristics of a pulse: area, height, and width. The pulse height measures the maximum digitized value for the pulse, the pulse area calculates the sum of all height areas for the pulse, and the pulse width calculates $\frac{\text{area}}{\text{height}} \times 64000$

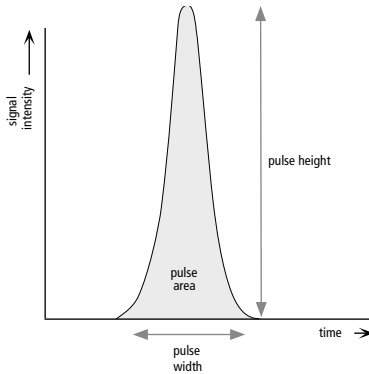

You can select which pulse characteristics you want to measure for each parameter using the Parameters tab. Pulse area (A) is measured by default. The Parameters tab also contains voltage controls that allow you to amplify signals by applying a voltage to PMTs or an electronic gain to the FSC signal. As the voltage is increased, the detector sensitivity increases, resulting in increased signal. As the voltage is decreased, the detector sensitivity decreases, resulting in decreased signal.

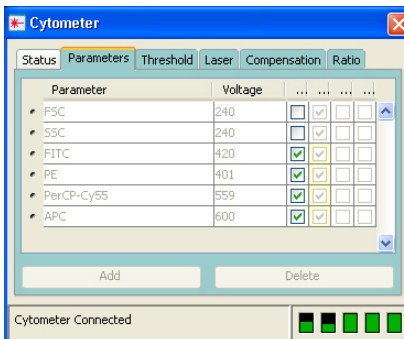

Digital data is displayed on an 18-bit linear scale, from 2.6–262,144. Select the Log checkbox to convert the display to a log scale. The Experiment Inspector contains an option to display log data on a four- or five-decade scale. (See the *BD FACSDiva Software Reference Manual* for more information.)

Laser Delay

Sample interrogation takes place within the cuvette flow cell. Fiber optic cables are used to direct laser light through a series of prisms that focus each laser on the stream at a separate position. This allows optimal detection of fluorescence signals from each laser with minimal cross-contamination from the other beams.

In a three-laser system, the red laser intercepts the stream first, followed by the blue and then the violet laser. Because the laser signals are spatially separated, there is a slight delay between the detection of each laser's signal (Figure 2-13).

Figure 2-13 Signal separation over time

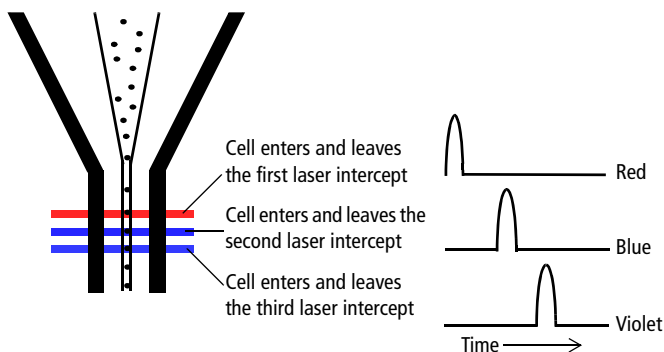

The delay factor in BD FACSDiva software is used to realign the signals so they can be measured and displayed on the same time scale. Note that signals are aligned with respect to the blue laser, so the red laser signals always have a negative delay value.

When using a fourth laser beam spot, you will notice a difference in default laser delays with the 561-nm or 445-nm laser compared to a three-laser configuration.

Laser delay is set automatically when you use the CS&T module. For information about manually adjusting the laser delay, see Manual Adjustment of Laser Delay on page 164.

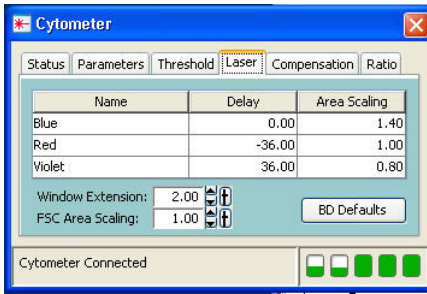

Sorting

During sorting, drop-drive energy is applied to the stream to break it into highly uniform droplets. Droplets detach from the stream a few millimeters downstream from the nozzle. The time between when a particle intercepts the laser and when it reaches the droplet breakoff point is determined using BD FACS Accudrop technology (see Drop-Delay Overview on page 71).

When a particle is detected and meets the predefined sorting criteria, an electrical charge is applied to the stream just as the droplet containing that particle breaks off from the stream. Once broken off from the stream, the droplet—now surrounded by air—still retains its charge. The charged droplet passes by two strongly charged deflection plates. Electrostatic attraction and repulsion cause each charged droplet to be deflected to the left or right, depending on the droplet’s charge polarity. Uncharged droplets are not affected by the electric field and pass down the center to the waste aspirator. See Figure 2-14 on page 65.

The following sections describe how the BD FACSAria Fusion cytometer creates and charges drops, how the drops are deflected, and how sorting populations are identified.

Figure 2-14 Sorting

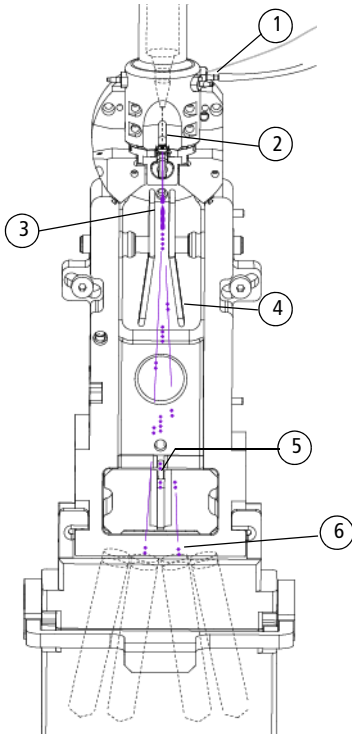

No.	Description
1	Charge is applied via the stream-charging wire in the barb.
2	The sample generates light scatter and fluorescence signal. The signal is analyzed.
3	The charged droplet breaks off.
4	Deflection plates attract or repel the charged droplet.
5	Uncharged droplets pass to waste.
6	Charged drops containing particles of interest are collected.

Drop Formation





The BD FACSAria Fusion cytometer constantly applies drop-drive energy to the stream. Droplets form as soon as you turn on the stream. Sample interrogation takes place upstream of the stream vibration so that analysis is not affected by the drop drive.

A drop breakoff image is created using an LED strobe and a video camera. The image is displayed in the Breakoff window (see Breakoff Window on page 66). Patented Sweet Spot technology analyzes the drop breakoff image and provides feedback to the appropriate cytometer controls.

Breakoff Window

Use the Breakoff window to control a number of aspects related to drop formation.

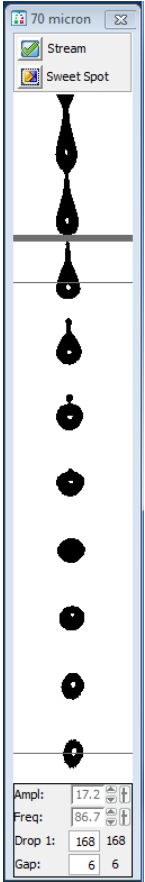
Table 2-1 Breakoff window controls

Control	Description	
Stream button   On Off	Turns the stream on and off.	
Sweet Spot button   On Off	Enables automatic adjustment of the drop-drive amplitude to maintain the stability of the breakoff point. When the Sweet Spot is on, the Amplitude and Frequency fields are disabled. The amplitude is automatically adjusted by the software. To enable the fields, turn off the Sweet Spot.	
Amplitude field	Adjusts the amplitude or intensity of the drop drive, from 1.0–80.0 volts. The drop-drive amplitude determines the breakoff point. A higher amplitude value results in a shorter stream breakoff. A lower amplitude results in a longer stream breakoff. Typically, the amplitude is set once, at the beginning of a sorting experiment, and then maintained using the Sweet Spot.	
Frequency field	Determines the number of drops formed per second and the size of the drops. (Drop size is also influenced by the nozzle size.) The drop-drive frequency can be adjusted from 1.0–102.0 kHz. The higher the frequency, the more drops are generated per second and the smaller the drops. The lower the frequency, the fewer drops generated per second and the larger the drops.	

Control	Description
Frequency field (continued)	In general, the drop-drive frequency should not need adjustment. We recommend using the default values that are entered with each Sort Setup mode.
Drop 1 field	<p>The distance between the top of the image and the center of the first broken-off drop, from 100–600 pixels.</p> <p>When you enter a value and turn on the Sweet Spot, the cytometer automatically adjusts the amplitude to attain your target value.</p> <p>Note that not all Drop 1 targets are attainable. The Drop 1 value jumps in whole increments of approximately 57 pixels according to your drop spacing.</p> <p>The same Drop 1 setting can be used from day to day. A difference of up to 10 pixels between the target value and the actual value is acceptable.</p>
Gap field	<p>This represents the gap between the stream breakoff and the top of the first drop.</p> <p>The default Gap setting for a 70-micron nozzle is 6 pixels.</p>

Breakoff Functionality

The upper camera transmits an image of the drop breakoff to the Breakoff window, where video image processing software converts the visual characteristics of the image into numerical properties. The drop breakoff is analyzed for two key features: Drop 1 and Gap.

Drop 1 is defined as the number of pixels from the top of the image to the center of gravity of the first broken-off drop. A thin gray line on the image is used to identify this drop. The number shown to the right of the Drop 1 field at the bottom of the window is the actual pixel location of the gray line. The number entered into the Drop 1 field is the user-defined Drop 1 target.

The Gap is defined as the number of pixels from the first discontinuity in the stream to the next stream object, generally the first broken-off drop. A gray line of varying thickness represents the Gap. The number shown to the right of the Gap field is the pixel width of the gray line. The number entered into the Gap field is a user-defined target.

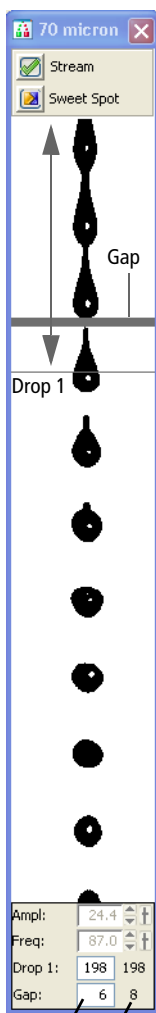

Target Value Actual Value

When the Sweet Spot is turned on, the drop-drive amplitude (Ampl) is automatically adjusted to approximately match the target Drop 1 and Gap values. The amplitude is initially adjusted in larger increments until Drop 1 is achieved. The amplitude is then adjusted in smaller increments until the cytometer attains the target Gap. The Sweet Spot function will make adjustments as necessary to maintain the required breakoff conditions throughout the day.

The Sweet Spot performs two other functions during sorting. When sorting, if the Drop 1 or Gap is out of range, sorting is paused until the values are back within range. This ensures that sorting occurs only under the proper breakoff conditions. If a more severe problem such as a clog is detected by the Sweet Spot, the stream is shut off and sorting is stopped, the deflection plates shut off, the aspirator drawer closes, and the sample tube is unloaded.

Pre-programmed values can be downloaded to the Breakoff window by selecting one of the nozzle sizes (70, 85, 100, or 130 micron) from the Sort > Sort Setup menu.

Note that changes to values in the Sort Setup windows (Breakoff and Side Stream) are automatically saved. At startup, the last settings used on the cytometer are restored, except the Stream and Sweet Spot controls, which always default to off. For more information, see Sort Setup on page 103.

Typically, when setting up for sorting, use the Amplitude to set the required drop breakoff, and copy the generated Drop 1 value to the target field. Then, turn on the Sweet Spot to maintain the drop breakoff. When the Sweet Spot detects a >1-pixel difference between the target Gap setting and the actual Gap, it adjusts the amplitude to reduce the Gap. When a >2-pixel difference is detected, the Sweet Spot stops sorting temporarily (stops charging the stream) until the Gap is restored. Note that when the sort is paused, the sample continues to flow. Once the Gap is back within range, sorting automatically resumes.

For information on setting the breakoff, see Setting Up the Breakoff on page 123.

Side Stream Formation

Side streams are formed when the voltage is on and a sort is in progress, or when you click Voltage, then Test Sort in the Side Stream window.

The Side Stream window displays an image of the side streams as transmitted by the lower camera. In addition to the stream image, the Side Stream window contains the controls used to adjust electrical charges and to determine the drop delay using Accudrop, as described in Drop-Delay Overview on page 71.

Figure 2-15 Side Stream window

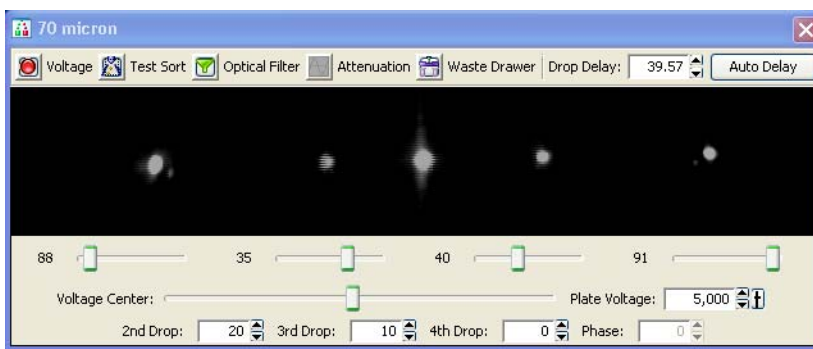

Controls in the Side Stream window are described in Table 2-2 on page 70. You can send different values to the Side Stream window by selecting a nozzle size from the Sort > Sort Setup menu.

Note that changes to values in the Sort Setup windows (Side Stream and Breakoff) are linked to the sort setup and are automatically saved. At startup, the last settings used on the cytometer are restored, except the states of the Voltage, Test Sort, and Optical Filter buttons, which always default to off. For more information, see Sort Setup on page 103.

Table 2-2 Side Stream window controls











Control	Description
Voltage button  On  Off	Turns the plate voltage on and off.
Test Sort button  On  Off	Generates test side streams based on test sort pulses.
Optical Filter button  In  Out	Controls the position of the optical filter in front of the lower (Accudrop) camera.
Attenuation button  Off  On	Decreases the amplitude of the drop drive. At lower pressures, you may need to turn on attenuation to dampen the amplitude.
Waste Drawer button  Closed  Open	Opens or closes the aspirator drawer depending on its current state. The default state is closed. For more information, see Aspirator Drawer on page 32.
Drop Delay field	Sets the amount of time between when an event is measured and the breakoff point, from 10–140 drops. The drop-delay value determines which drop will be deflected. The drop-delay value is set in an experiment using BD FACS Accudrop technology.
Auto Delay	Opens the Auto Drop Delay dialog.
Voltage sliders (far left, left, right, far right)	Set the percentage of charge to be applied to the corresponding stream (as a percentage of maximum).
Voltage Center slider	Adjusts the relative voltage between the left and right plates which moves the streams slightly to the left or right as a whole. In general, this slider rarely needs adjusting.

Table 2-2 Side Stream window controls (continued)

Control	Description
Plate Voltage field	Adjusts the total voltage difference between the plates, which determines the angle of stream deflection. The voltage values change with different nozzle sizes.
2nd, 3rd, 4th Drop fields	Apply a correction factor for the drop charge as a percentage of the previous drop, from -100% to 100%.
Phase field	Adjusts the phase between drop generation and charging of the droplets from 0–360°. The selected value is sent to both the drop-charging electrode and the drop strobe. In general, the Phase does not need adjusting. You can keep the default value of zero.

Drop-Delay Overview

The BD FACSAria Fusion cytometer includes integrated Accudrop technology to assist in setting an accurate drop delay value. Accudrop components consist of the following:

- A diode laser, mounted to the left of the sort block
- A camera that provides an image of the side streams
- An emission filter for viewing the fluorescence from BD FACSTM Accudrop beads

The emission filter is installed in front of the lower camera and can be moved in and out by clicking the Optical Filter control. When the button is green (), the filter is out. This position is used to view the center and side streams.

Click the button to move the filter in front of the camera when you are determining the drop delay. The button changes to red (). To determine the drop delay, the streams are illuminated by the diode laser just below the point of deflection. Specialized fluorescent particles (Accudrop beads) can be viewed in the center and left side streams as the delay is adjusted. The best delay yields the most particles in the left stream and the fewest in the center stream.

See Determining the Drop Delay – Manual Method on page 176 for more information.

Auto Drop Delay

The Auto Drop Delay feature enables the system to optimize the drop delay automatically. See Determining the Drop Delay – Automatic Method on page 181.

Drop Charging

Drops are charged when an event is detected and meets the defined sorting criteria, as specified in the Sort Layout window.

The Sort Layout window contains all sorting instructions and controls (Figure 2-16). The sort layout designates which device will be used to collect sorted particles and which particles will be sorted into each sort location. Up to four sort counters can be displayed in the window to give ongoing status during a sort. Depending on your system's configuration, your setup values may vary. For more information about the Sort Layout window, see Table 3-2 on page 104.

Figure 2-16 Sort layout for a four-way sort

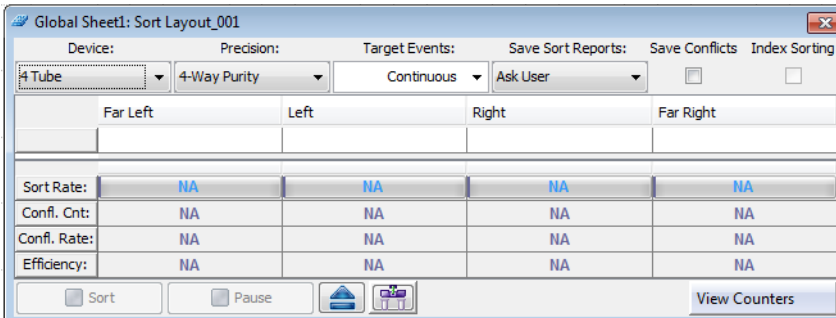

Target events are identified by drawing gates around populations of interest in plots. The Sort Layout window specifies which gated population should be sorted into each sort collection tube or spot in a plate or on a slide. During sorting, when an event is identified within one of the sort gates, the drop containing the

particle of interest is charged by the stream-charging wire attached to the flow cell. See Figure 2-17.

Figure 2-17 Flow cell with stream-charging wire

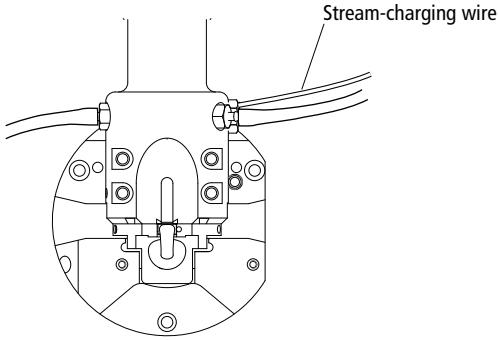

The amount and type of charge determine where the drop will be sorted. For example, in a four-way sort, drops with the most charge will be deflected into the outer streams, while drops with less charge will be deflected into the inner streams.

Conflict Resolution During Sorting

During sorting, the cytometer deflects drops based on the characteristics of the particles in each drop and where the user wants to deflect them. Conflicts can occur depending on the type of target particle, where the particle is located within a drop, or whether the drop is free of contaminating particles. BD FACSDiva software accurately measures particle position to within 1/32 of a drop.

Mask settings determine how drops are deflected when sorting conflicts occur. There are three mask settings, each of which addresses a different type of conflict. These settings are combined to define sort precision modes. Each mode is made up of a set of masks. Precision modes are defined in the Sort Precision dialog, accessed from the Sort menu.

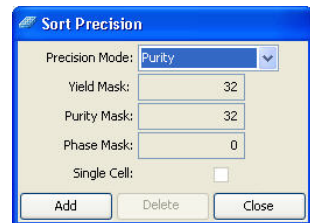

Yield Mask

The yield mask setting defines how close to the edge of the drop, in 1/32-drop increments, a particle of interest can be located before sorting an additional drop. Half of each yield mask setting defines an equal area at each end of the drop.

For example, when the yield mask is set to 16 and an event is within 8/32 from the beginning of a drop, the previous (leading) drop will be sorted. If an event is within 8/32 from the end of a drop, the following (trailing) drop will be sorted. See Figure 2-18.

Figure 2-18 Target particle within a yield mask of 16

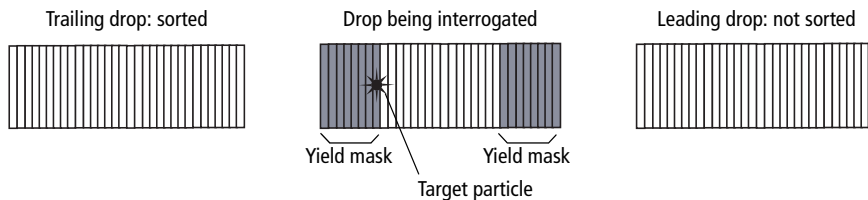

If the yield mask were set to 8 for the same target particle, the target particle would fall outside the yield mask. Therefore, no additional drops would be sorted. See Figure 2-19.

Figure 2-19 Target particle outside a yield mask of 8

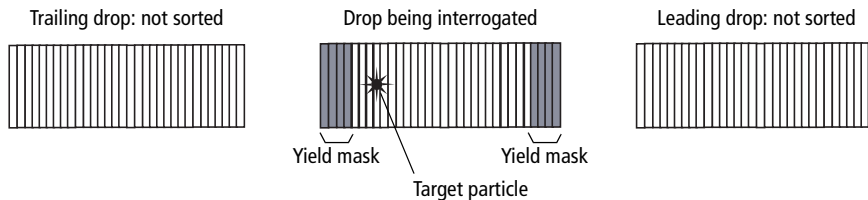

When the yield mask is set to zero, only one drop (the drop containing the target particle) will be deflected. When the mask is set to 32, two drops will always be deflected. Yield masks between 0 and 32 will sort either one or two drops.

Yield masks cannot be used in conjunction with phase masks. Therefore, when the yield mask is greater than zero, the phase mask automatically reverts to zero.

Purity Mask

The purity mask setting defines how close, in 1/32-drop increments, a contaminating drop can be located before ignoring the drop being interrogated.

For example, when the purity mask is set to 16, the drop being interrogated will not be sorted if a non-target particle falls within the first or last 8/32 of the leading or trailing drop. In the following example, a non-target particle falls within the first 8/32, so the interrogated drop will not be sorted. See Figure 2-20.

Figure 2-20 Non-target particle within a purity mask of 16

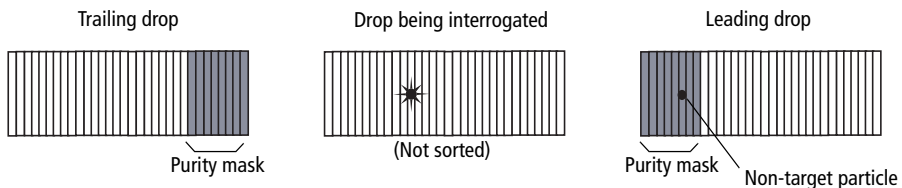

If the purity mask were set to 8 for the same target particle, the non-target particle would fall outside the purity mask, so the interrogated drop would be sorted. See Figure 2-21.

Figure 2-21 Non-target particle outside a purity mask of 8

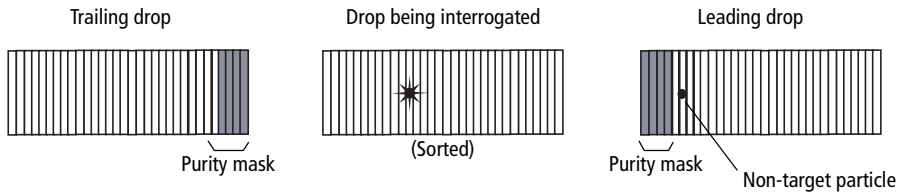

With any purity mask greater than zero, the drop being interrogated must be free of contaminating particles or the drop will not be sorted. If the purity mask is set to zero, a droplet containing the event of interest will be sorted regardless of contaminating particles.

Phase Mask

Particles near the drop edge can affect the breakoff and alter the trajectory of the deflected drop. The phase mask restricts drop deflection when an event is too close to the edge of a drop or when there are events close to the edge of adjacent drops. A phase mask is used to improve counting accuracy and side-stream quality at the expense of yield.

For example, when the phase mask is set to 16, the drop being interrogated will be sorted only if the target particle falls outside the phase mask. See Figure 2-22.

Figure 2-22 Sorted and unsorted drop with phase mask of 16

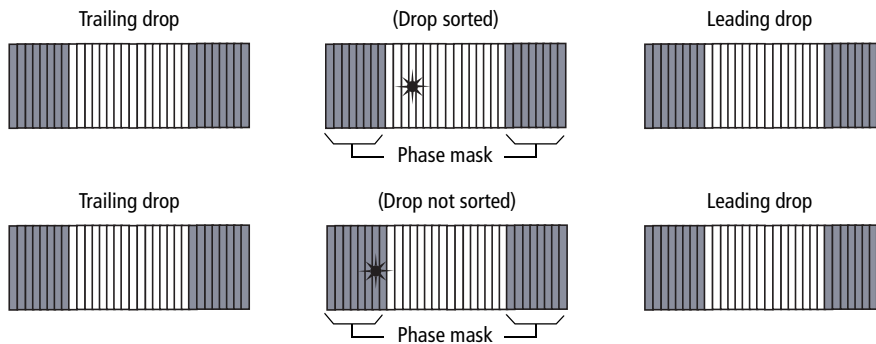

Decreasing the phase mask to 8 allows more drops to be sorted. However, because the target particle is closer to the edge of the drop, there is more variability in drop trajectory. See Figure 2-23.

Figure 2-23 Sorted drop with phase mask of 8

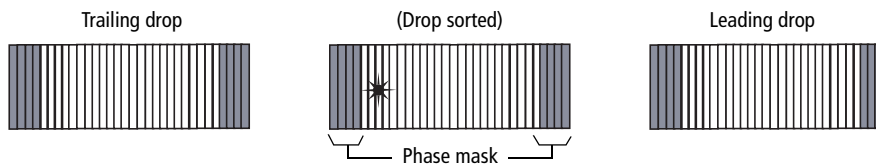

Tip We recommend using a phase mask of at least 8 when sorting single cells.

Phase masks cannot be used in conjunction with yield masks. Therefore, when the phase mask is greater than zero, the yield mask automatically reverts to zero.

Sort Precision Modes

Mask values can be combined in many different ways. By default, six sort precision modes are already defined: Purity, 4-Way Purity, Yield, Single Cell, Initial, and Fine Tune.

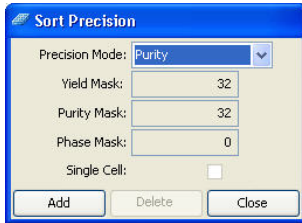

	Precision Mode					
	Purity	4-Way Purity	Yield	Single Cell	Initial	Fine Tune
Yield Mask	32	0	32	0	32	0
Purity Mask	32	32	0	32	0	0
Phase Mask	0	0	0	16	0	0
Single Cell	–	–	–	X	–	–

- Purity mode.** The yield mask is set to the maximum to obtain the greatest number of particles. Because the purity mask is also set to the maximum, only drops free of contaminating particles will be sorted. Sorting in Purity mode results in a sorted sample that is highly pure, at the expense of recovery and yield.
- 4-Way Purity mode.** The purity mask is set to the maximum, so only drops free of contaminating particles will be sorted. The yield mask is set to zero to ensure that residual charges from adjoining drops do not degrade the quality of side streams. The 4-Way Purity mode is recommended for four-way sorting when precise deflection is required.

- **Yield mode.** Only the yield mask is used at its maximum value. Recovery and yield are optimized at the expense of purity. The yield mode could be used as a first round sort for enrichment of target particles, followed by a sort for purity.
- **Single Cell mode.** The purity mask is set to the maximum, so only drops free of contaminating particles will be sorted. The phase mask is set to half the maximum, so only particles centered within the sorted drop are deflected. Drop trajectory and count accuracy are optimized at the expense of yield. This mode is recommended for plate sorting or situations when precise counting is required.

The remaining modes are used mainly during drop-delay determination. Initial mode is equivalent to Yield mode, but it is named differently as a reminder to use this as the initial mode when using Accudrop to set the drop delay.

- **Initial mode.** Only the yield mask is used at its maximum value. Recovery and yield are optimized at the expense of purity.
- **Fine Tune mode.** All masks are set to zero to deflect the maximum number of drops. This mode is used to fine-tune the drop-delay value. See Determining the Drop Delay – Manual Method on page 176 for more information.

Defining New Precision Modes

Default precision modes cannot be edited or deleted. However, you can create new modes and then select them from the Precision Mode menu.

- 1 Select **Sort > Sort Precision**.

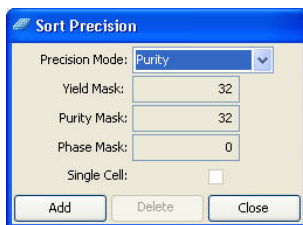

2 Click **Add**.

The current sort mode is duplicated and the Mask fields are enabled.

3 (Optional) Change the name of the mode in the Precision Mode field.

4 Enter values for Yield Mask, Purity Mask, and Phase Mask.

5 Select the **Single Cell** checkbox, if needed.

6 Click **Close**.

The new mode is added to the Precision Mode menu.

To delete a mode, select it from the **Precision Mode** menu and click **Delete**.

THIS PAGE INTENTIONALLY LEFT BLANK

Using BD FACSDiva Software

Many BD FACSAria Fusion cytometer functions are controlled using BD FACSDiva software. This chapter provides a general overview of the workspace components and describes software controls that are unique to the BD FACSAria Fusion cytometer. For an in-depth description of software components not described in this chapter, see the *BD FACSDiva Software Reference Manual*.

The following topics are covered in this chapter:

- Workspace Components on page 82
- Cytometer Controls on page 83
- Sorting Controls on page 101
- Templates on page 114

Workspace Components

When you start BD FACSDiva software, the workspace opens (See Figure 3-1). For a general overview of the workspace and to get started using the software, see the tutorials and quick reference guides located in the Resource Library on the BD Biosciences website (bdbiosciences.com). When running BD FACSDiva software with the BD FACSAria Fusion, two additional windows can be displayed by clicking the Sorting button on the Workspace toolbar. See Sorting Controls on page 101 for a description.

Figure 3-1 BD FACSDiva workspace

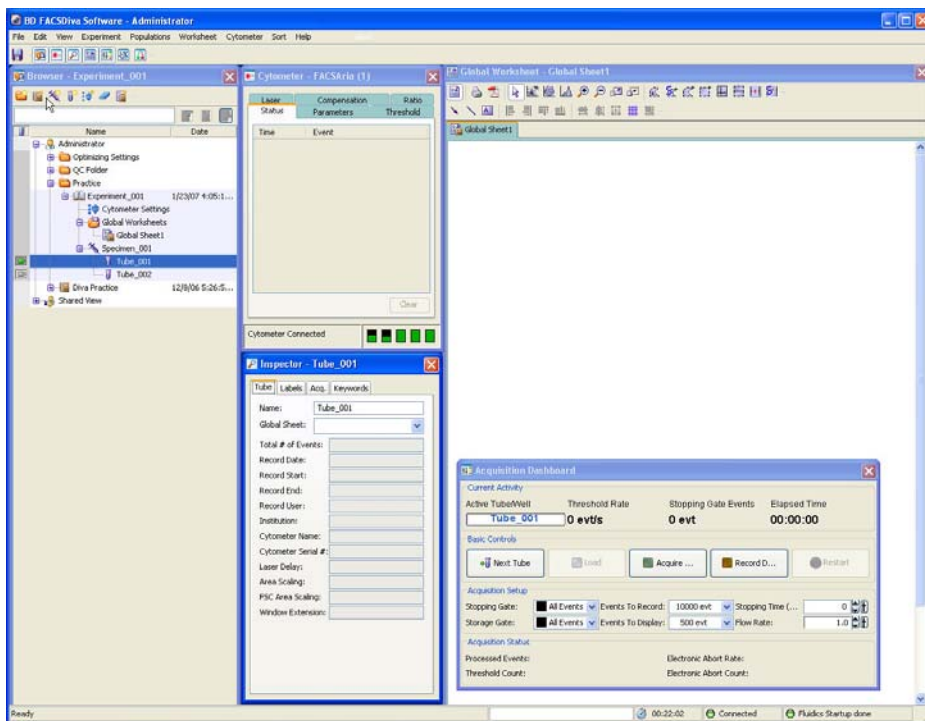

Cytometer Controls

Most BD FACSAria Fusion–specific cytometer controls are accessed through the Cytometer menu. Controls on the Cytometer menu are described in the following sections:

- Fluidics Controls on page 83
- Cytometer Configuration on page 87
- Cytometer Status Report on page 90

The Cytometer Details and the Catalogs menu commands are described in the *BD FACSDiva Software Reference Manual*. Additional cytometer controls are located on the Acquisition Dashboard. See Acquisition Controls on page 100.

Fluidics Controls

Fluidics control of the BD FACSAria Fusion cytometer is partially automated by BD FACSDiva software. The software contains pre-programmed fluidics protocols that are activated by selecting the corresponding menu command from the Cytometer menu. In addition, fluidics level indicators are available in the Cytometer window. See Fluidics Level Indicators on page 86.

Fluidics Startup

During fluidics startup, waste and sheath levels are verified and the fluidics system is primed with sheath solution. The fluidics status is displayed at the bottom of the main window.

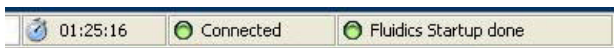

See Cytometer Startup on page 116 for more information.

Fluidics Shutdown

Fluidics shutdown removes sheath fluid from the lines, replaces it with ethanol, and cleans the cuvette with a cleaning solution. See Fluidics Shutdown (Weekly or As Needed) on page 207 for more details.

Change Sample Filter

Sample line filters can be installed to filter a sample before sorting. This selection opens the Sample Filter Change wizard, which guides you through the process. See Installing or Removing a Sample Line Filter on page 239 for the instructions.

Cleaning Modes

BD FACSDiva software contains pre-programmed cleaning modes that are activated by selecting the corresponding menu command from the Cytometer > Cleaning Modes menu. See Internal Cleaning on page 212 for more information.

Sheath Pressure

The sheath pressure determines how quickly particles pass through the laser beam. Select Cytometer > Sheath Pressure to view the current sheath pressure and change the pressure for custom sort setups.

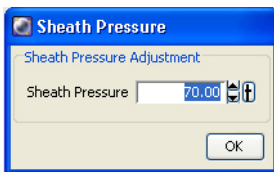

Each sort setup option is optimized at a preset sheath pressure. If you change the sheath pressure, many other values will be affected and need updating, including the drop-drive frequency, drop-delay value, laser delay, and area scaling factor. For proper cytometer operation, change the sheath pressure by selecting an option from the Sort > Sort Setup menu. Do not adjust the pressure using controls in the Sheath Pressure dialog. Note that the Sheath Pressure command is disabled when the Sweet Spot is on.

Sample Agitation

Select Cytometer > Sample Agitation to specify the speed at which samples are agitated. You can select from one of the specified values, or select Off to turn off agitation.

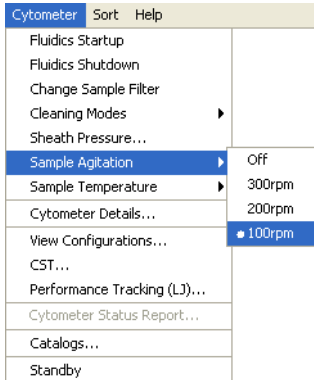

Sample Temperature

Use the Sample Temperature command to set the temperature inside the sample injection chamber. You can select from one of the specified values, or select Off to turn off temperature control (Figure 3-2).

Figure 3-2 Setting the sample temperature

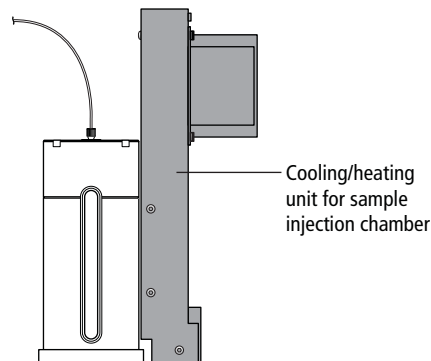
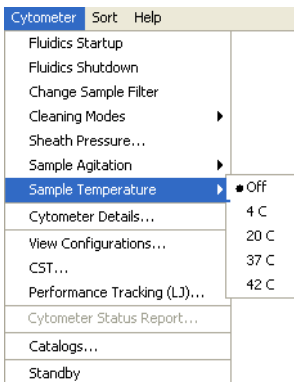

The cooling/heating unit is designed to maintain the temperature of a sample tube. It is not designed to cool or heat the sample. It takes approximately 45 minutes to reach the required temperature inside the chamber, during which time the chamber must be kept closed.

To cool or heat the chamber, install a sample tube and click Load. Click Stop Acquiring to keep the chamber closed and stop running the sample. To maintain the temperature, do not leave the chamber open for extended periods while changing sample tubes.

The sample temperature retains the last setting after startup. For example, if it was set to 20°C the last time the system was used, then it will return to that setting the next time the system is started up.

Fluidics Level Indicators

BD FACSDiva software provides fluidics level indicators in the Cytometer window (Figure 3-3). The sheath and waste indicators provide an approximate indication of the fluid levels in each tank. The DI, bleach, and ethanol tank indicators appear full until the fluid level is below 20% of the tank capacity. When this occurs, the corresponding level indicator changes to black.

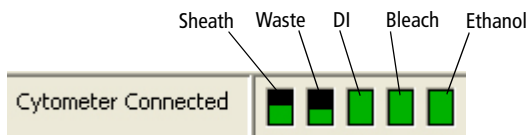

NOTE The stainless steel ethanol shutdown tank does not have a level sensor. It must be checked manually.

Figure 3-3 Fluid level indicators



When the sheath is low or the waste is full while the stream is running, the corresponding indicator turns red and the following warning message is displayed every 5 minutes until the stream is turned off. If the warning message is not closed, the system automatically turns off the stream after 15 minutes.



  Do not close the warning message without refilling the sheath or emptying the waste. If you continue to run the cytometer after closing the message, the system could shut down.

Cytometer Configuration

The menu selections shown in Figure 3-4 open the CS&T module in a separate window. The CS&T module enables you to perform multiple functions related to cytometer configuration.

NOTE When the CS&T module is open, BD FACSDiva software goes into a holding mode and does not accept any user input. When CS&T is closed, BD FACSDiva software becomes active again.

Figure 3-4 Cytometer menu selections that open CS&T

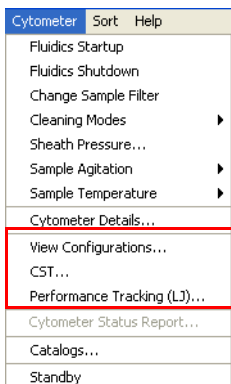

- **View Configurations.** Opens the Cytometer Configuration window within the main CS&T window. See the following section for an overview of this function.
- **CST.** Opens the CS&T module. See the *BD Cytometer Setup and Tracking Application Guide* for complete information on using CS&T.
- **Performance Tracking (LJ).** Opens the performance tracking feature within the main CS&T window. See the *BD Cytometer Setup and Tracking Application Guide* for complete information on using this feature.

Cytometer Configuration Window

The BD FACSAria Fusion cytometer is equipped with a specific set of lasers, filters, and dichroic mirrors. The Cytometer Configuration window lets you define which fluorochromes or cell parameters will be measured at each PMT detector. Within this window, you can define parameters for an unlimited number of fluorochromes, up to four lasers, and all of the detectors.

Select **Cytometer > View Configurations** to open the window shown in Figure 3-5. Click the **Parameter** tabs for a list of parameters. Click the **Filters and Mirrors** tab for the list of optics.

The Cytometer Configuration window also displays the following settings:

- Sheath pressure
- Nozzle size
- Window extension

See the *BD Cytometer Setup and Tracking Application Guide* for more information on editing configurations, including adding parameters, mirrors, and filters.

Figure 3-5 Example configuration for a four-laser system

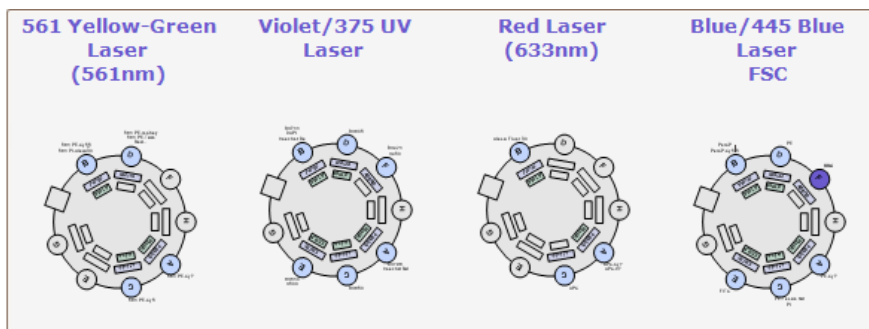

Before you start any experiment, verify that the cytometer configuration contains the appropriate parameters for the samples you are running and that the cytometer optics match the current configuration. You cannot modify an existing configuration once it has been baselined. However, you can copy, paste, or modify a configuration as described in Custom Configurations on page 92.



For accurate data results, the cytometer optics must match the current cytometer configuration.

Selections in the Cytometer Configuration window determine which parameters are available for your experiment. When more than one parameter is available for a detector, the first parameter is listed by default. To select a different parameter, click the name in the **Parameters** tab of the **Cytometer** window in BD FACSDiva software and select a different parameter from the menu.

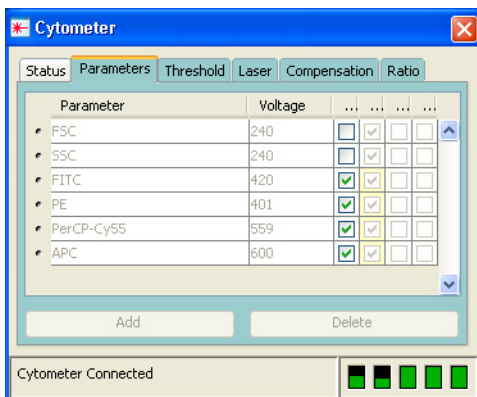

Cytometer Status Report

The Cytometer Status Report provides a list of all cytometer settings at the time the report was created. The cytometer must be connected to create the report. In an open experiment, click to set the current tube pointer and select **Cytometer > Cytometer Status Report**. The report is displayed in a separate window with a menu bar above the report header. The header lists the cytometer name, type, serial number, and the date and time the report was generated. See Figure 3-6 on page 91 for a sample report.

For a full description of the Cytometer Status Report, see the *BD FACSDiva Software Reference Manual*. A BD FACSAria Fusion cytometer report includes the following additional information: user access privileges, cytometer information, cytometer settings, and sorting settings. The report can be printed or exported.

- The User Access Privileges section lists access settings for the current user.
- The Cytometer Info section lists values for laser delay, area scaling, window extension, FSC area scaling, sheath pressure, and sample flow rate.
- The Parameters section displays settings for the current acquisition tube.
- The Sort Settings section lists all sort setup values, along with the Plate Voltage and Voltage Center values. If the Sweet Spot is off, Breakoff and

Gap values are shown. If the Sweet Spot is on, Drop 1 and target Gap values are shown.

Figure 3-6 Cytometer Status Report

Cytometer Name: FACSAriaIII		Cytometer Status Report		Date: 2013.07.08 at 08:52:11							
Serial Number: 1											
User Access Privileges											
Window Extension Access					Yes						
FSC Area Scaling Access					Yes						
Laser Delay Access					Yes						
Laser Area Scaling Access					Yes						
Edit Drive Setups Access					Yes						
Cytometer Info											
Laser		Delay		Area Scaling							
961 Yellow-Green		0.0		1.2							
Violet		-54.0		0.75							
Red		54.0		0.35							
Blue		0.0		1.0							
Window Extension				2.0							
FSC Area Scaling				1.0							
Sheath Pressure				45.00							
Sample Flow Rate				2.0							
Parameters											
Parameter	Type	Log		Voltage							
FSC	A, H, W	Off		334							
SSC	A, H, W	Off		292							
FITC	A, H	On		900							
PerCP-Cy5-5	A, H	On		675							
PE	A, H	On		461							
APC	A, H	On		400							
BV421	A, H	On		356							
BV605	A, H	On		583							
BV650	A, H	On		600							
PI	A, H	On		466							
Hoechst blue	A, H	On		428							
PE-Cy5,5	A, H	On		412							
PE-Cy7	A, H	On		448							
Threshold											
Parameter				Value							
FSC				5000							
Threshold Operator				Or							
Spectral Overlap (%)											
Channels / Colors	FITC	PerCP-Cy5-5	PE	APC	BV421	BV605	BV650	PI	Hoechst blue	PE-Cy5,5	PE-Cy7
FITC	100.00	0.00	0.00	0.00	0.00	0.00	0.00	0.00	0.00	0.00	0.00
PerCP-Cy5-5	0.00	100.00	0.00	0.00	0.00	0.00	0.00	0.00	0.00	0.00	0.00
PE	0.00	0.00	100.00	0.00	0.00	0.00	0.00	0.00	0.00	0.00	0.00
APC	0.00	0.00	0.00	100.00	0.00	0.00	0.00	0.00	0.00	0.00	0.00
BV421	0.00	0.00	0.00	0.00	100.00	0.00	0.00	0.00	0.00	0.00	0.00
BV605	0.00	0.00	0.00	0.00	0.00	100.00	0.00	0.00	0.00	0.00	0.00
BV650	0.00	0.00	0.00	0.00	0.00	0.00	100.00	0.00	0.00	0.00	0.00
PI	0.00	0.00	0.00	0.00	0.00	0.00	0.00	100.00	0.00	0.00	0.00
Hoechst Blue	0.00	0.00	0.00	0.00	0.00	0.00	0.00	0.00	100.00	0.00	0.00
PE-Cy5,5	0.00	0.00	0.00	0.00	0.00	0.00	0.00	0.00	0.00	100.00	0.00
PE-Cy7	0.00	0.00	0.00	0.00	0.00	0.00	0.00	0.00	0.00	0.00	100.00
Sort Settings											
Sort Setup									85 micron		
Frequency									46.00		
Amplitude									32.00		
Phase									0.00		
Drop Delay									30.00		
Attenuation									Off		
Sweet Spot									Off		
Breakoff									150		
Gap									7		
Plates Voltage									4,000.00		
Voltage Centering									0		
Side Stream Voltage (%)											
Far Left			Left						Right		Far Right
100.00			35.00						35.00		100.00
Neighboring Drop Charge (%)											
2nd											3rd
											4th

Custom Configurations

Before you can record data, you must first ensure that the cytometer configuration is appropriate for the experiment. If needed, you can create custom configurations to add parameters or filters and mirrors that are not listed in the base configuration. You will also need to create custom configurations for each sheath pressure you would like to run.

When creating custom configurations, use descriptive names that make it easy to identify the configuration. See the *BD FACSDiva Software Reference Manual* and the *BD Cytometer Setup and Tracking Application Guide* for more information.

Preparing for Custom Configurations

Custom configurations can be created only by users with administrator access. The easiest way to create a custom configuration is to copy and edit a base configuration. You can also create a new, blank configuration.

- 1 Log in to the software as an administrator.
- 2 Select **Sort > Sort Setup** and select the setup mode that matches the nozzle size you are using.
- 3 Verify that the correct nozzle is installed, then start the stream.
- 4 Select **Cytometer > CST**.

The Cytometer Configuration window opens (see Figure 3-5 on page 89). For users with administrator access, the window displays the Parameters and Filters and Mirrors tabs, which are not visible to users with operator access.

NOTE When you create a new configuration in CS&T, you need to run a new baseline for that configuration. Once the baseline is established, you cannot edit any of the settings in the configuration.

Adding Parameters, Filters, and Mirrors

Before creating a custom configuration, verify that the necessary parameters, filters, and mirrors required for the custom configuration are defined.

- 1 To add new parameters, do the following in the **Parameters** tab:
 - a Click **Add**.
 - b Enter a parameter name in the field provided.

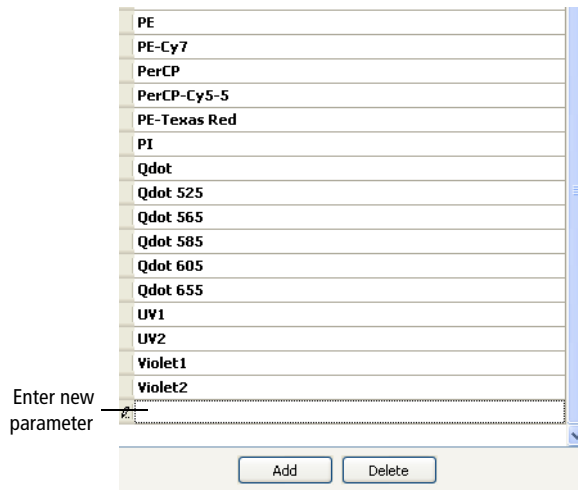

- 2 To add filters or mirrors, do the following in the **Filters and Mirrors** tab:
 - a To add a filter, click **Add** under the Filter list. To add a mirror, click **Add** under the Mirror list.
 - b Select a pass type and enter a wavelength in the field provided.

Filters		Mirrors	
Band Pass	585/15	Long Pass	575
Band Pass	576/26	Long Pass	556
Band Pass	575/26	Long Pass	550
Band Pass	560/20	Long Pass	545
Band Pass	530/30	Long Pass	505
Band Pass	525/50	Long Pass	502
Band Pass	510/50	Long Pass	475
Band Pass	488/10		
Band Pass	485/22		
Band Pass	450/50		
Band Pass	450/40		
Band Pass	450/20		
Band Pass	440/40		
Band Pass	405/20		
Band Pass			

Copying a Base Configuration

You cannot edit or delete your base configuration. However, you can use it as a starting point to create a custom configuration.

- 1 In the **Configurations** tab, right-click the **Base Configurations** folder and select **New Folder**.
- 2 Rename the new folder *Custom Configurations*.
- 3 Right-click the base configuration and select **Copy**.

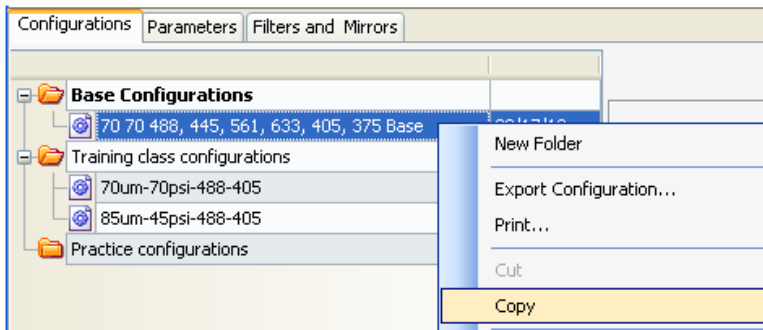

- 4 If your base configuration contains lasers that share optical paths, you have to select which laser will be active by making selections in the dialog similar to the one shown in the following figure.

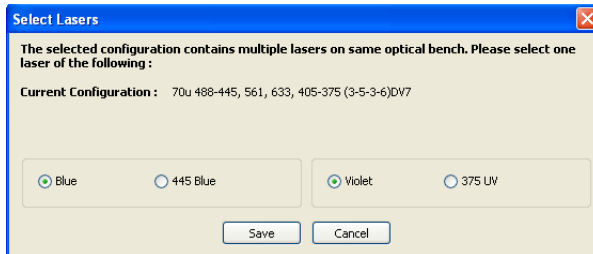

- 5 Right-click the **Custom Configurations** folder and select **Paste**.

A copy of the base configuration is added to the Custom Configurations folder.

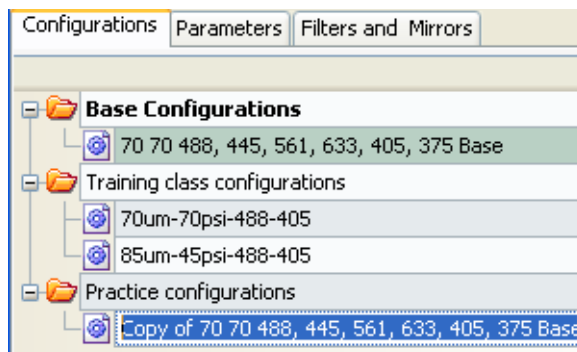

- 6 Enter a descriptive name and press **Enter**.

For example, use the name *70-70*, meaning 70-micron nozzle at 70 PSI. If you need to rename the configuration, right-click the new configuration and select **Rename**.

Editing the Copied Configuration

Once the base configuration is copied, you can customize the parameters, filters, and mirrors in the configuration.

- 1 In the configuration list, right-click the new configuration and select **Edit Configuration**.

The following window opens.

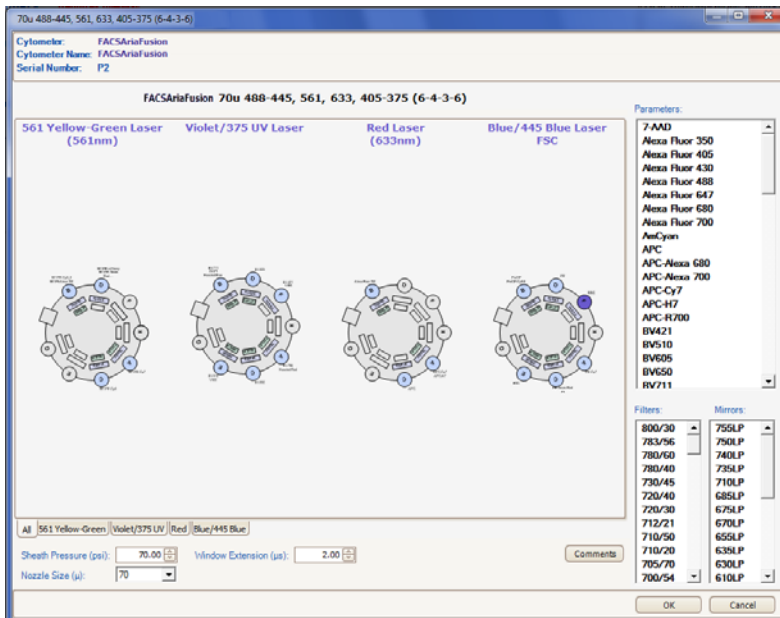

Use the tabs at the bottom of the window to view each laser's detectors separately.

- 2 To edit the nozzle size and sheath pressure for this configuration:

See Table 3-2 on page 104 for typical sort setup values.

- a Enter the appropriate sheath pressure value at the bottom of the configuration window.

b Select the appropriate nozzle size.

Sheath Pressure (psi): Window Extension (μs):

Nozzle Size (μ):

3 Do the following to edit the optical configuration.

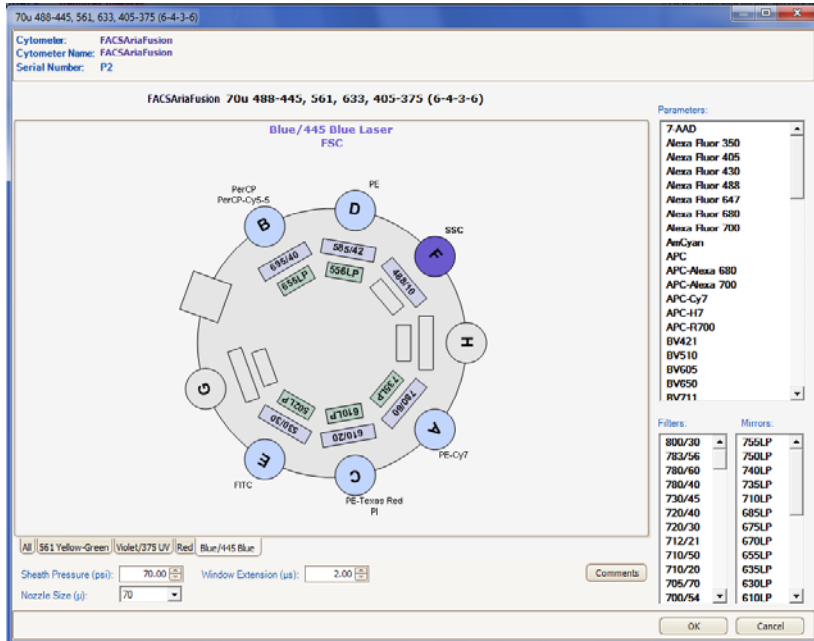

- To change the parameter label for a detector, select and drag a new parameter from the **Parameters** list to the appropriate detector.
- To add more than one parameter label to a detector, Ctrl+click the parameters in the **Parameters** list, then drag them to the detector.
- To change a filter, select and drag a new filter from the **Filters** list to the filter slot.

- To change a mirror, select and drag a new mirror from the **Mirrors** list to the mirror slot.

When you drag parameter labels to a detector, any labels already assigned to that detector are deleted. Therefore, when assigning multiple parameter labels to a detector, you must drag all appropriate labels to the detector at the same time.

Setting the Configuration

To verify that you have selected the correct configuration, do the following.

- 1 Select **Cytometer > CST**.
- 2 Select the appropriate configuration and select **Set Configuration**.
- 3 Select **File > Exit** to exit CS&T.

A mismatch dialog is displayed.

- 4 Select **Details**, and then select **Use CST Settings**.

Verifying that the Configuration Matches the Sort Setup

To verify that the sheath pressure in the sort setup matches the sheath pressure in the configuration:

- 1 Select **File > Exit** to exit CS&T.
- 2 Select **Sort > Sort Setup**, and select the sort setup that matches the nozzle size listed in your configuration.

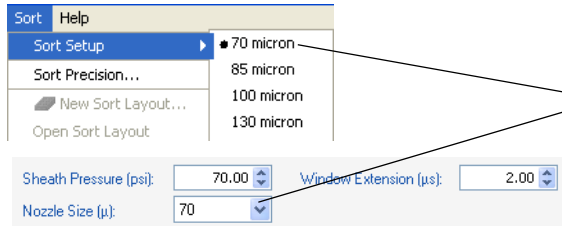

Select the sort setup that matches the nozzle size listed in your configuration.

- 3 Select **Cytometer > Sheath Pressure** and verify that the pressure matches the pressure in your configuration. Enter a new sheath pressure, if needed.

The new sheath pressure is automatically saved with the current sort setup mode.

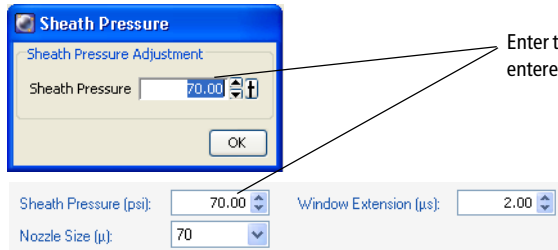

Enter the same sheath pressure that was entered in the configuration.

- Tip** The name of the configuration is displayed at the top of the BD FACSDiva workspace. If you use a descriptive name for each configuration (such as *100-15-Custom*, for nozzle size-sheath pressure-sort setup mode), it will be easier to verify that the appropriate settings match without going back to view the configuration.

Acquisition Controls

Along with the controls described in the *BD FACSDiva Software Reference Manual*, the following acquisition controls are available for the BD FACSAria Fusion cytometer.



- **Load.** Lifts a tube into the sample injection chamber, starts sample agitation (if agitation is turned on), and starts acquisition of the sample.

When a tube is already loaded, the button changes to Unload. Clicking Unload stops acquisition of the sample, turns off the agitator, and lowers the tube from the sample injection chamber.

NOTE The Load button is enabled only when the workstation is connected to the cytometer, an experiment is open, the stream is turned on, and the current tube pointer is set to a tube.

- **Stop Acquiring.** Stops sample acquisition without unloading the sample tube.

The Acquire Data button functions only when a tube is loaded.

- **Flow Rate.** Controls sample flow rate, from 1.0–11.0 (10–80 $\mu\text{L}/\text{min}$).

Do one of the following to change the flow rate:

- Select the value in the field and enter a new value.

- Click the pointer in the slider bar and drag it to a new value.
- Use the mouse to click the up and down arrows or press the arrow keys on your keyboard to increase or decrease the values in small increments.

Sorting Controls

All sorting on the BD FACSAria Fusion cytometer is controlled by BD FACSDiva software. Sorting controls are shown in Figure 3-7. See Table 3-1 on page 102 for explanations of each area.

Figure 3-7 BD FACSDiva sorting controls

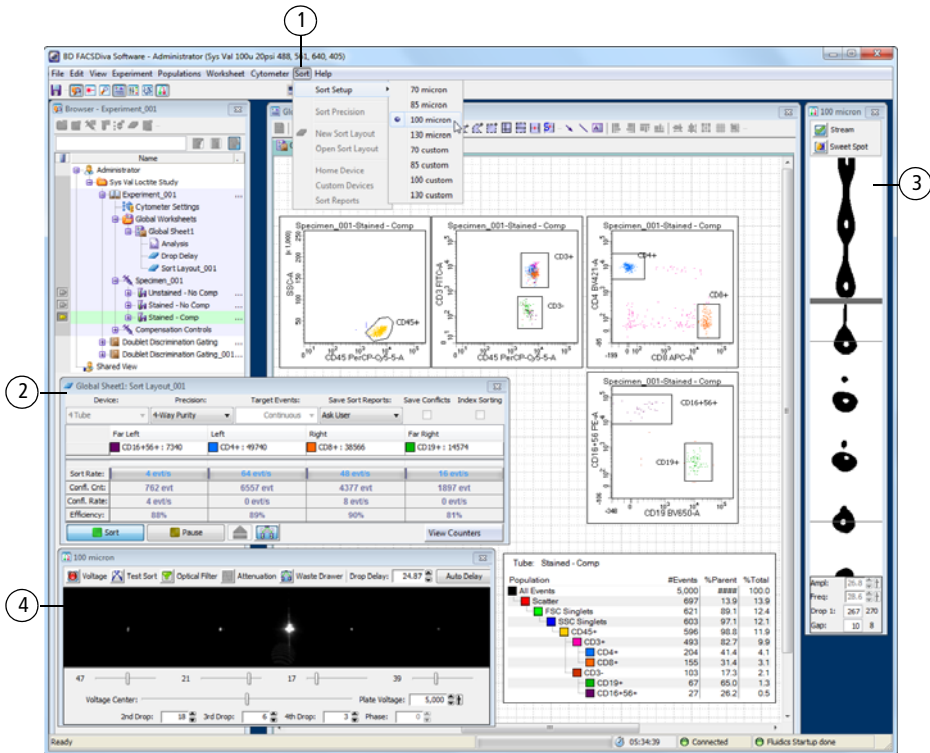

Table 3-1 Description of sorting controls

No.	Description
①	The Sort menu provides access to the sort setup and sort precision modes, sort layouts, sort reports, and sort devices used with the ACDU unit. See Sort Menu on page 102.
②	The Sort Layout window contains controls to turn on index sorting and designates which device will be used to collect sorted particles and which particles will be sorted into each sort location. Depending on your system's configuration, your setup values may vary. See Table 3-2 on page 104 for more information.
③	The Breakoff window displays an image of the stream and contains controls to adjust drop formation. See Drop Formation on page 65.
④	The Side Stream window displays an image of the side streams, and contains controls to adjust electrical charges and the drop delay. See Side Stream Formation on page 69.

Sort Menu

Select commands in the Sort menu for the following:

- **Sort Setup.** Downloads the most recently used settings for the selected nozzle size. See Sort Setup on page 103.
- **Sort Precision.** Opens a dialog where you can select or define a sort precision mode for handling sorting conflicts. See Conflict Resolution During Sorting on page 73.
- **New Sort Layout.** Opens the default 2-Tube Sort Layout window where other sort layouts can be selected. (Note that clicking the **Sort Layout** button on the **Browser** toolbar performs the same function.)
- **Open Sort Layout.** Opens an existing sort layout. A sort layout must be selected in the Browser for this menu command to be enabled. Alternatively, double-click any sort layout to open it.

- **Home Device.** Opens a dialog containing commands to move the tray support arm, either manually or to the home position. See Setting Up the Stream on page 194.
- **Custom Devices.** Opens a dialog where custom devices can be defined. See Creating a Custom Device on page 197.
- **Sort Report.** Displays a report showing the sort settings, acquisition counters, and sort layout information from the current sort. See Sort Report on page 112.

Sort Setup

Sort setup values for four different nozzle sizes can be downloaded using the **Sort > Sort Setup** command. Default settings are provided for each sorting option, along with a custom setting for each option.

As a general rule, for optimal results when sorting large or fragile cells, use a larger nozzle size and lower pressure. To increase throughput and yield when sorting smaller or less fragile cells, use a smaller nozzle size and higher pressure.

Sort Setup Name	Nozzle (microns)	Default Pressure (PSI)
70 micron	70	70
85 micron	85	45
100 micron	100	20
130 micron	130	10

If you make changes to any of the settings, the changes are automatically saved when you exit BD FACSDiva software or when you switch to a different sort setup mode. When you restart, the most recently used set of values is restored. Default settings are shown in Table 3-2 on page 104.

In addition, the Sort Setup menu has following menu items: 70 Custom, 85 Custom, 100 Custom, and 130 Custom. Initially, all of these new setups are exact copies of the corresponding original setups with the same defaults. This allows

you to create two sets of sort values (pressure, for example) for the same nozzle size.



Do not use a nozzle size that is different from the sort setup setting. The gap values and sensitivity algorithms are optimized for particular nozzles and are not suitable for other nozzle sizes. The system performance could be unstable.

Table 3-2 shows default sort setup values. Depending on your system's configurations, your setup values may vary. We recommend optimizing these settings for your system's configurations.

Table 3-2 Typical sort setup values

Setting	70 micron	85 micron	100 micron	130 micron
Sheath pressure	70	45	20	10
Amplitude	60	32	12	24
Frequency	87	47	30	12
Drop 1	150	150	150	150
Gap (upper limit)	6 (14)	7 (17)	10 (21)	12 (21)
Attenuation	Off	Off	Off	Off
Drop delay	47.00	30.00	27.00	16.00
Far left voltage	100	100	80	60
Left voltage	40	35	30	20
Right voltage	40	35	30	20
Far right voltage	100	100	80	60
Plate voltage	4,500	4,000	2,500	2,000
2nd drop	20	20	10	0
3rd drop	10	10	5	0
4th drop	0	0	0	0

Table 3-2 Typical sort setup values (continued)

Setting	70 micron	85 micron	100 micron	130 micron
Laser delay (blue)	0.00	0.00	0.00	0.00
Laser delay (red)	-78.00	-71.00	-80.00	-78.00
Laser delay (violet)	39.00	35.00	40.00	39.00
Laser delay (yellow green)	-39.00	-35.00	-40.00	-39.00
Area scaling (blue)	0.70	1.00	0.90	0.90
Area scaling (red)	0.60	0.75	0.65	0.65
Area scaling (violet)	0.50	0.50	0.50	0.50
Area scaling (yellow green)	0.80	0.80	0.90	0.95
Window extension	2.00	2.00	2.00	4.00

The Sort Layout window contains all sorting instructions and controls. The sort layout designates which device will be used to collect sorted particles and which particles will be sorted into each sort location. Up to four sort counters can be displayed in the window to give ongoing status during a sort.

Only one sort layout can be open at a time, but you can create several layouts for a single tube, as long as each sort layout has a different name. Sort layouts can also be added to global worksheets.

Sort layouts are available for up to eleven default collection devices (shown in the following figure). Additional custom devices can be defined. See *Creating a Custom Device* on page 197.

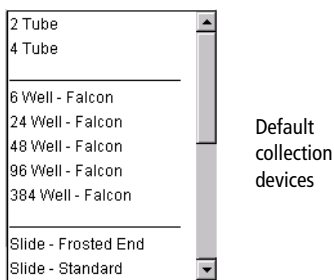

Examples of sort layouts for different devices are shown in the following figures. Instructions for setting up a sort layout can be found in Setting Up a Sort Layout on page 107.

Figure 3-8 Sort layout for collection tubes (top) and for a 48-well plate (bottom)

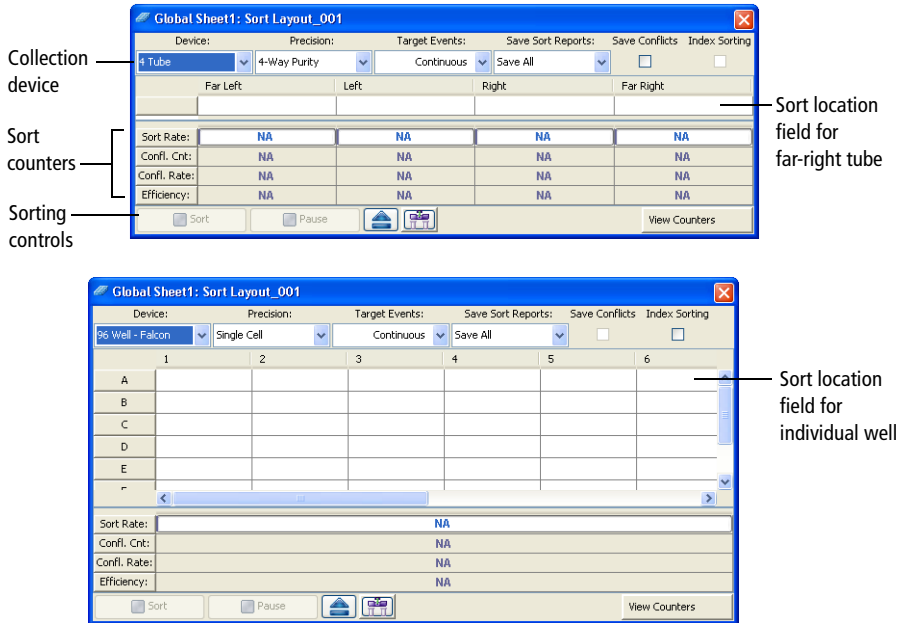
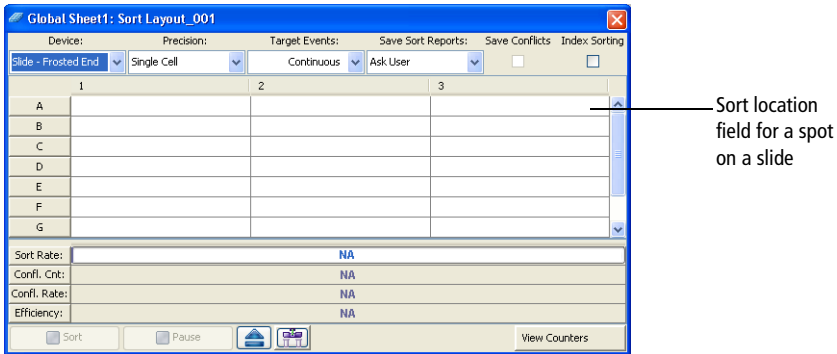

Figure 3-9 Sort layout for a frosted slide



Setting Up a Sort Layout

Sort layouts can be added to tubes or global worksheets.

- Create tube-specific layouts if you are sorting different populations or using different sort devices for each tube in the experiment.
- Create global worksheet-specific layouts if you are sorting the same populations into the same sort device for all tubes in the experiment.

NOTE To create a tube-specific sort layout, make sure a normal worksheet (white tab) is shown in the Worksheet window before you create the layout.

To set up a sort layout:

- 1** Select the icon for a tube or global worksheet in an open experiment and click the **New Sort Layout** button on the **Browser** toolbar.
- 2** In the **Sort Layout** window, select the type of device from the **Device** menu.

Default sorting devices are listed along with any defined custom devices. The Sort Layout window changes depending on the selected device. The number of rows and columns in the window matches the number of tubes, wells, or spots in the collection device.

- 3** Select the sort precision mode from the **Precision** menu.

For more information, see Sort Precision Modes on page 77.

- 4** Enter the number of events to be sorted in the **Target Events** field.

Once entered, the number of events can be selected from the Target Events menu. For continuous sorting, select **Continuous** from the **Target Events** menu.

- 5** Select one of the following options from the **Save Sort Reports** menu:
 - **Save None.** Sort reports are not saved.

- **Save All.** Automatically saves a sort report each time the sort is stopped.
- **Ask User.** Prompts the user each time the sort is stopped to select whether or not to save the sort report. This is the default option.

This setting is saved with the sort layout.

- 6 Select the field(s) corresponding to the tube(s), well(s), or spot(s) where the population will be sorted and select a defined population from the **Add** menu.

When you click in a sort location field, a menu opens allowing you to add, delete, or clear all populations in the field (Figure 3-10).

Figure 3-10 Adding populations to be sorted

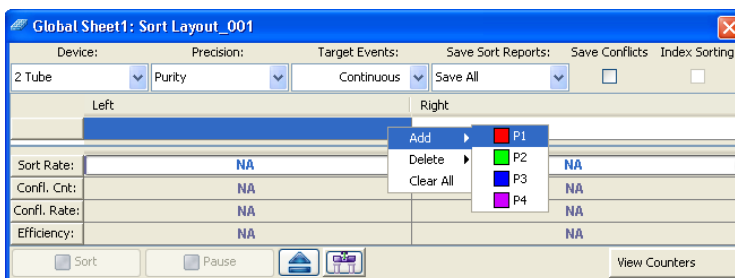

After you add a population, the population and the number of target events are added to the corresponding sort location field.

- Tip** Select a row or column header to select all fields in that row or column. When you add a population, it will be added to all selected fields at once.

- 7 Specify whether to save sort conflicts by selecting the **Save Conflicts** checkbox.

This checkbox is enabled only when using a two- or four-tube layout. When selected, all sort conflicts are sorted into a default location.

- For a two-tube layout, conflicts are sorted to the right.



- For a four-tube layout, conflicts for the far left tube are sorted to the left, and conflicts for the far right tube are sorted to the right.

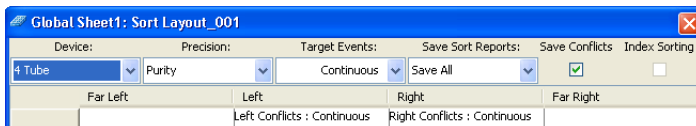

Editing a Sort Layout

- To change the number of events for any population, click in the **Sort Location** field(s) containing the population, then select a number from the **Target Events** menu or enter a new number.
- To remove a population from a sort location field, select the field, then select the corresponding population from the **Delete** menu.
- To clear all populations from a field, select the field, then select **Clear All**.

Using Sorting Controls

Sorting controls are located at the bottom of the Sort Layout window. Use these controls for the following functions.

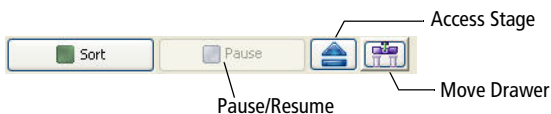

- **Sort.** Starts sorting events for the current acquisition tube. All counters reset to zero when this button is clicked. Events are sorted until the requested number of sorted events has been reached.

Click the **Sort** button again to stop sorting before reaching the requested number of events. The counters stop at the number of sorted events. If you click **Sort** to restart sorting, the counters reset to zero.

- **Pause/Resume.** Stops sorting, but not acquisition. Sort counters and sort timers freeze when the Pause button is clicked. Click the **Resume** button to continue sorting and to continue incrementing the sort counters and timers. See Pausing and Resuming a Sort on page 189.
- **Access Stage.** When the ACDU stage is in the back, the stage is moved forward to put a plate on or take a plate off the stage. When the stage is in the front, the stage is moved to the back and out of the way so you can install a collection tube holder.
- **Move Drawer.** Moves the aspirator drawer in (closed) or out (open) depending on its current state. The default state is in. For more information, see Aspirator Drawer on page 32.

Using Counters

Counters provide ongoing status during sorting. Counter fields cannot be edited. To display fewer counters in the Sort Layout window, click the **View Counters** button and select a menu option. The corresponding counter is hidden. (Only counters with a checkmark next to the name are displayed.)

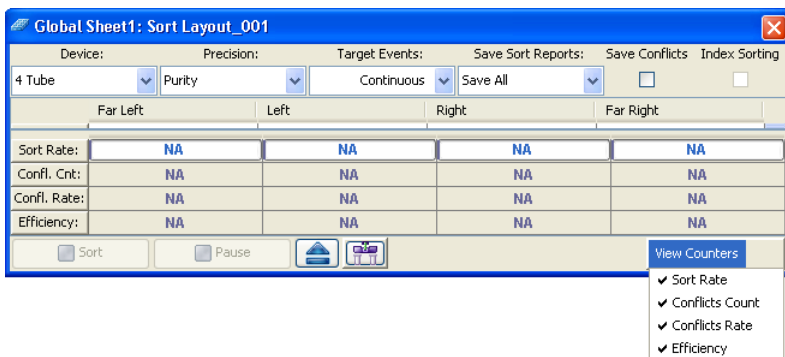

Counters display the following information:

- **Sort Rate.** Number of events per second that met the sort criteria and were sorted.
- **Conflict Count.** Number of events that met the sort criteria but were not sorted because of conflicts.
- **Conflict Rate.** Number of conflicts per second.
- **Efficiency.** Number of sorted events/(sort conflicts + sorted events) x 100.

Monitoring a Sort

During sorting, each sort location field displays the number of actual sorted events (Figure 3-11). When a target number is specified, the field displays the actual number of events along with the number of target events.

A progress bar opens behind the sort rate counter field showing the progress of the sort.

Figure 3-11 Sort layout during sorting

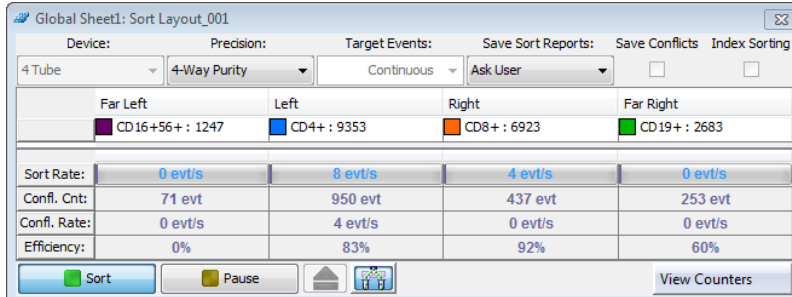

Sort Report

Select **Sort > Sort Reports** to view all of the saved reports for the current sort layout (see Figure 3-12). A sort report can be printed or exported. The **Sort Reports** menu option is enabled if either of the following is true: a sort layout is selected in the Browser (even if experiment is closed), or a sort layout is open. If both conditions are true, the Browser selection takes precedence.

Figure 3-12 Select Sort Reports dialog

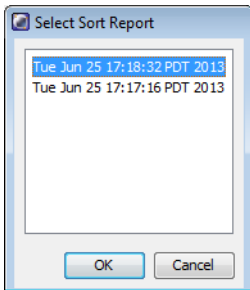

A sort report (see Figure 3-13) contains the following:

- **Header information.** Experiment name, specimen name, tube name, sort layout name, software name and version, the date and time of printing, type of collection device, user ID, and cytometer.
- **Sort Settings.** Sort setup values, precision mode, mask definitions, etc.
- **Acquisition Counters.** Threshold count, processed events count, electronic conflicts count, and elapsed time.
- **Sort Counters.** Counter values per sort destination, or total sort count if sorting sequentially.
- **Sort Layout.** Population(s), sort count, and target event count for each sort location field.

Figure 3-13 Typical sort report

Experiment : Experiment_001		Sort Report		Report Date : 2013.06.21 at 16:01:30	
Specimen : Specimen_001				Device : 4 Tube	
Tube : Stained - Comp				User ID : Administrator	
Sort Layout : Sort layout_001				Cytometer : FACSAriaFusion (P65670000002)	
Application : FACSDiva Version 8.0					
Sort Settings					
Sort Setup	100 micron	Precision		4-Way Purity	
Frequency	28.6	Yield Mask			0
Amplitude	27.1	Purity Mask			32
Phase	0.00	Phase Mask			0
Drop Delay	24.87	Single Cell			Off
Attenuation	Off	Plates Voltage			5,000
Sweet Spot	On	Voltage Centering			0
First Drop	267	Sheath Pressure			20.00
Target Gap	10				
Side Stream Voltage (%)					
Far Left	Left	Right		Far Right	
47.00	21.00	17.00		39.00	
Neighboring Drop Charge (%)					
2nd		3rd		4th	
18.00		6.00		3.00	
Acquisition Counters					
Threshold Count				2050384	
Processed Events Count(evt)				2025940	
Electronic Aborts Count(evt)				7671	
Sort Elapsed Time(h:mm:ss)				00:28:40	
Sort Counters					
	Far Left	Left	Right	Far Right	
Sort Rate(evt/s)	0	0	0	0	
Conflicts Count(evt)	1727	13289	9706	3806	
Conflicts Rate(evt/s)	0	0	0	0	
Efficiency(%)	81	88	88	64	
Sort Layout					
	Far Left	Left	Right	Far Right	
	CD16+56+ : 12917	CD4+ : 89216	CD8+ : 67754	CD19+ : 24667	

The Sort Report window contains a File menu where you can select to print or export the report. Exported comma-separated value (CSV) files can be opened with a spreadsheet application such as Microsoft® Excel®.

Templates

When you install BD FACSDiva software for the BD FACSAria Fusion cytometer, the following additional experiment templates are installed in the BD Export\Templates directory:

- **Accudrop Drop Delay template.** Contains a single specimen and tube, a gated plot on a standard worksheet, and a predefined sort layout. This experiment is used for setting the drop delay during sorting as described in Determining the Drop Delay – Manual Method on page 176.
- **Doublet Discrimination Gating template.** Contains custom cytometer settings, a single specimen and tube, and three gated plots on a global worksheet. This experiment is used to eliminate doublets as described in Data Collection on page 148.

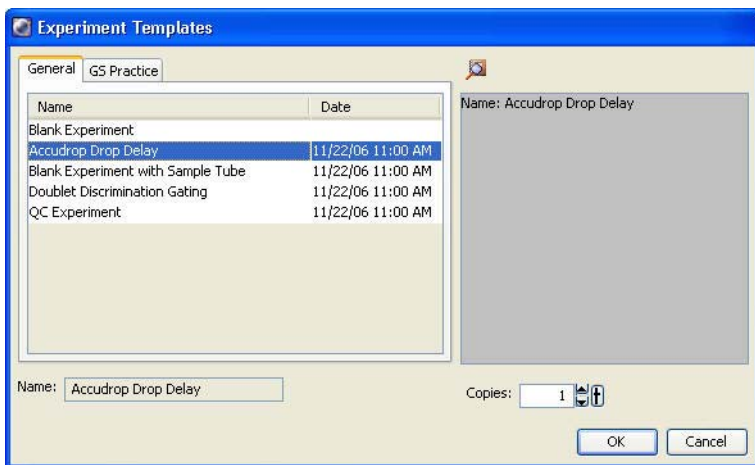

4

Startup and Running Samples

The following topics are covered in this chapter:

- Cytometer Startup on page 116
- Checking Cytometer Performance on page 134
- Application Settings on page 141
- Data Collection on page 148
- Data Recording and Analysis on page 155
- Manual Adjustment of Laser Delay on page 164

Cytometer Startup

Follow these steps to start up your BD FACSAria Fusion cytometer.

- 1 Turn on the cytometer main power.

Figure 4-1 Power panel

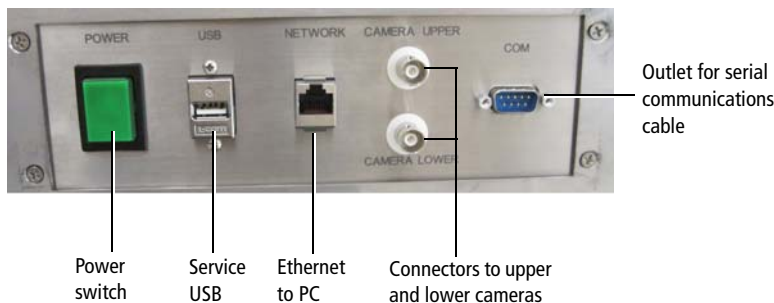

If the cytometer was just shut down, wait until the system is fully depressurized (stops hissing) before you turn on the main power.

- 2 Switch on the house air or the optional compressor and view the sheath tank gauge to ensure that the tank is pressurizing properly.
- 3 Start up the workstation.
- 4 Press the laser buttons on the laser power panel (Figure 4-2 on page 117) to turn on the lasers you will be using. Wait 30 minutes for the lasers to warm up.

NOTE The 405-nm and 375-nm lasers and the 488-nm and 445-nm lasers share the same optics. Do not operate the 405 and 375-nm lasers or the 488 and 445-nm lasers at the same time.

Figure 4-2 Laser power panel



The laser button is illuminated when the corresponding laser is on.

NOTE The laser buttons will vary depending on which lasers you have installed on your system. For example, if you have two lasers, only the first two buttons will be labeled and active.

- 5 If your system includes the BSC and it is not already on, turn on the blower by pressing the power button on the Cabinet Controls panel.

A green light indicates the power is on.

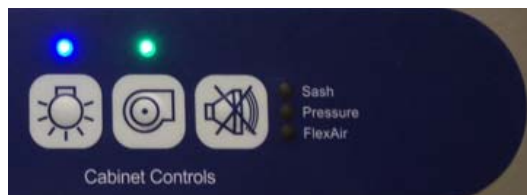

- 6 (Optional) If you are using the temperature control option, turn it on. See Chapter 12, Temperature Control Option on page 345.
- 7 Log in to Windows 7.0.
 - a Select **Operator login**.
 - b Type the password: **Welcome#1**
- 8 Open BD FACSDiva software by double-clicking the application shortcut on the desktop.

Figure 4-3 BD FACSDiva application shortcut

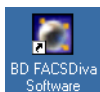

- 9 Log in with your user name and password.

If your login name is not displayed, contact your BD FACSDiva software administrator to create a login name for you. For more information, see the *BD FACSDiva Software Reference Manual*.

- 10 Check the fluid levels in the **Cytometer** window. Replenish fluids or empty the waste, if needed.

To display the **Cytometer** window, click the **Cytometer** button on the **Workspace** toolbar. Check the fluid levels at the bottom of the window (Figure 4-4). Roll the mouse pointer over fluid indicators to show the fluid type.

Figure 4-4 Fluid levels in the Cytometer window

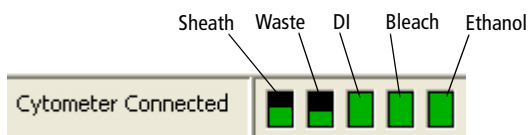

NOTE The ethanol level in the Cytometer window indicates the volume of fluid in the white auxiliary ethanol tank. There is no sensor for the stainless steel ethanol shutdown tank.

To service the fluid containers, see Table 4-1 on page 125 and Emptying the Waste Container on page 132.

Performing Fluidics Startup

This section describes the fluidics startup procedure. The status of the fluidics system is displayed in the bottom right corner of the main window.

- 1 From the BD FACSDiva Cytometer menu, select **Fluidics Startup**. The following window opens.

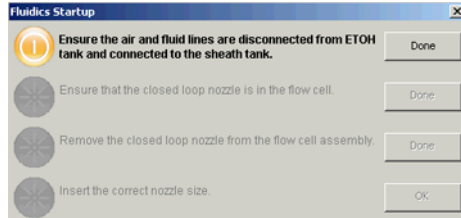

- 2 Verify that the air and fluid lines are disconnected from the ethanol tank and connected to the sheath tank, then click **Done**. See Figure 4-5.



Caution: Do not run fluidics startup with the air and fluid lines connected to the ethanol shutdown tank. This can cause damage to the system. Always verify that the lines are connected to the sheath tank.

Figure 4-5 Air and fluid lines connected to the sheath tank

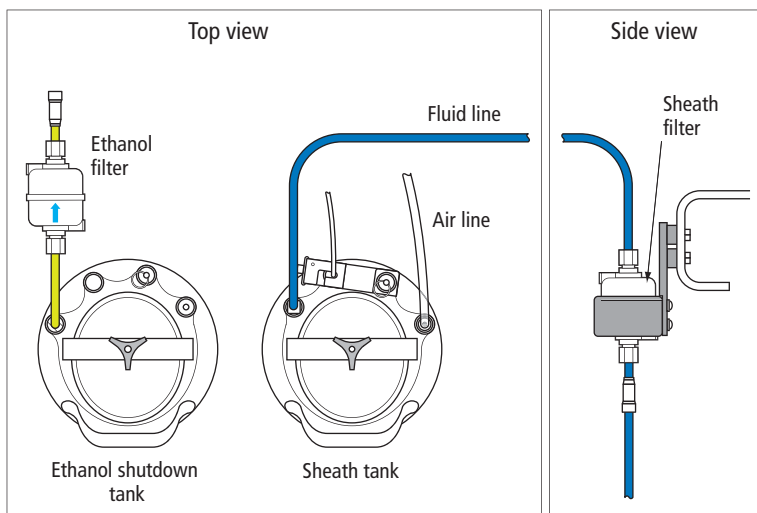

- 3 Verify that a closed-loop nozzle is installed in the flow cell, then click **Done**.

The fluidics startup process starts and the progress is displayed at the bottom of the dialog.

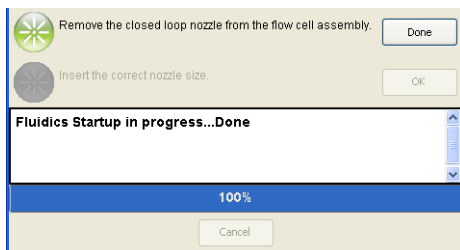

- 4 Turn the nozzle-locking lever counter-clockwise to the 9:00 position, pull the closed-loop nozzle out of the cuvette flow cell, then click **Done**.
- 5 Insert the correct nozzle size in the flow cell.
 - a Verify that the O-ring is present and that it is installed in the nozzle groove. For more information, see *Integrated Nozzle* on page 29.

If the stream is flowing but is unsteady, check for bubbles in the flow cell. If you see bubbles, turn off the stream, wait for 10 seconds, and turn on the stream again.

If you see any dripping or spraying, or the stream image appears abnormal, turn off the stream and see *Troubleshooting the Stream* on page 254.

4 Close the sort block door.

NOTE If you encounter bubbles in the sheath fluid stream at the 130-micron sort setting, perform a sample line backflush for approximately 1 minute. Select **Cytometer > Cleaning Modes > Sample Line Backflush**.

To prevent bubbles, the sheath tank should be depressurized while not in use to prevent air from dissolving into the sheath solution.

Setting Up the Breakoff

Establishing a stable drop pattern in the breakoff window is an important step in getting optimal results from the system. See Breakoff Window on page 66 for more information on the parameters and controls in the breakoff window.

The following figure shows good versus poor breakoff patterns.

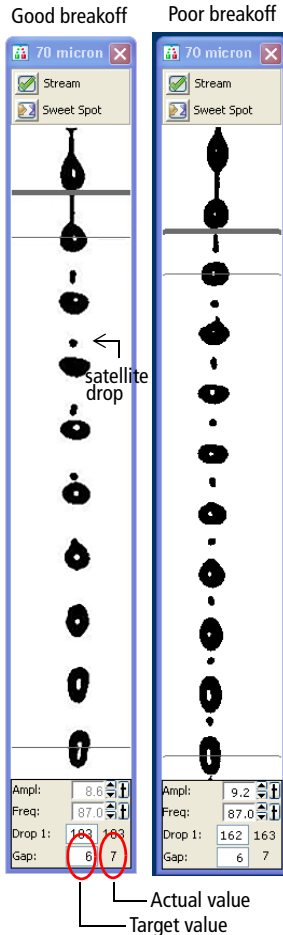

- 1 Adjust the **Ampl** slider until the drop breakoff is approximately in the top third of the **Breakoff** window.

Do not exceed 70 volts. If you cannot achieve a drop breakoff at <70 volts, do the following:

- Check the flow cell for air bubbles. If you see bubbles, turn the stream off and back on.
- Make sure the sheath pressure and drop-drive frequency are appropriate. See Table 3-2 on page 104 for starting values.
- If the amplitude is <10 volts, turn on attenuation in the **Side Stream** window. See Table 2-2 on page 70.

- 2 Verify that the small satellite droplets are merging with the large droplets.

If the satellites are not merging, you might need to clean the nozzle by sonicating. The satellite drops should merge into the drops in 6 satellites or fewer.

- 3 Enter the actual Drop 1 value as the target in the **Drop 1** field.

The actual value is displayed in the gray background next to the Drop 1 field. Once a valid target has been established, you do not need to reset it unless you change the nozzle or your sort setup option.



Tip If the target value causes the amplitude to exceed 70 volts, perform the recommendations under step 1 and re-enter the Drop 1 target value.

- 4 Turn on the Sweet Spot when the drop pattern is stable.

The Sweet Spot is designed to automatically adjust the drop-drive amplitude to maintain the stability of the breakoff point. When the Sweet Spot is on, the Amplitude and Frequency fields are disabled. The values are automatically adjusted by the software. For more information, see Breakoff Window on page 66.

The breakoff patterns in Table 4-1 are intended as examples. The patterns will not always look exactly like these.

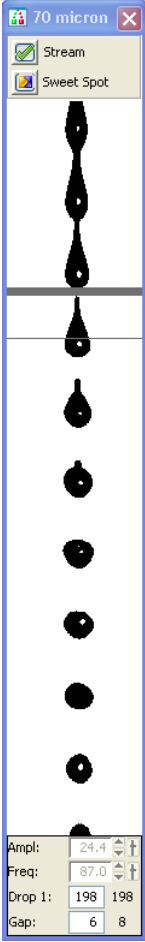
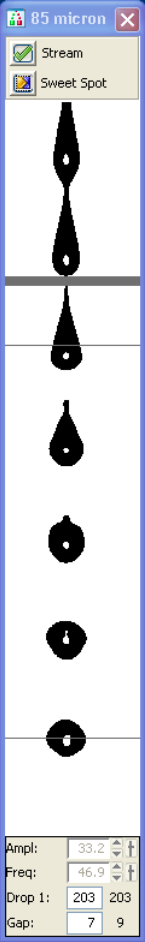
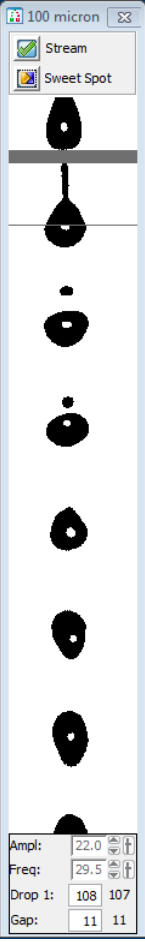
Table 4-1 Examples of breakoff patterns at each nozzle size

70 micron	85 micron	100 micron	130 micron
			

Setting Up the Fluidics

Check the fluid levels in the sheath tank and waste containers every time you use the cytometer. This ensures that you will not run out of sheath fluid during an experiment or have to service the containers during a sort. Fluid level indicators are shown in the Cytometer window in BD FACSDiva software. See Figure 4-4 on page 118.

If a fluid container is running low, refill it with the fluid indicated on the container label. For best results, fill the containers only with the fluids shown in Table 4-2. For ordering information, see Reagents on page 283.

For instructions on emptying the waste, see page 132.

Table 4-2 Recommended fluids

Container	Compatible Fluids	Capacity
Sheath ^a	<ul style="list-style-type: none">• BD FACSTFlow™ sheath fluid (non-sterile)• 1X phosphate-buffered saline (PBS), with or without preservatives	One 10-L stainless steel container
Ethanol Shutdown	70% solution diluted in deionized (DI) or laboratory-grade water	One 5-L stainless steel container
Bleach	<ul style="list-style-type: none">• 10% household bleach (0.5% sodium hypochlorite)• BD™ FACSClean solution	5 L
DI	Deionized water (Milli-Q or equivalent). Add 3 mL of bleach per liter of DI water.	5 L
Ethanol	70% solution diluted in DI or laboratory-grade water	5 L

a. Users should select solutions that are compatible with their specific samples and experiments.

NOTE Make sure the blue sheath fluid line between the sheath tank and the cytometer does not come into contact with anything that could introduce vibration that might affect the stability of the stream.

Refilling the Sheath Tank

The fluid level in the pressurized stainless steel sheath tank should be checked often and refilled when low. The startup times for the breakoff stream will increase when the tank is low. If the cytometer is run until the sheath supply is too low, the system will turn off the stream.

Figure 4-6 Sheath tank connectors

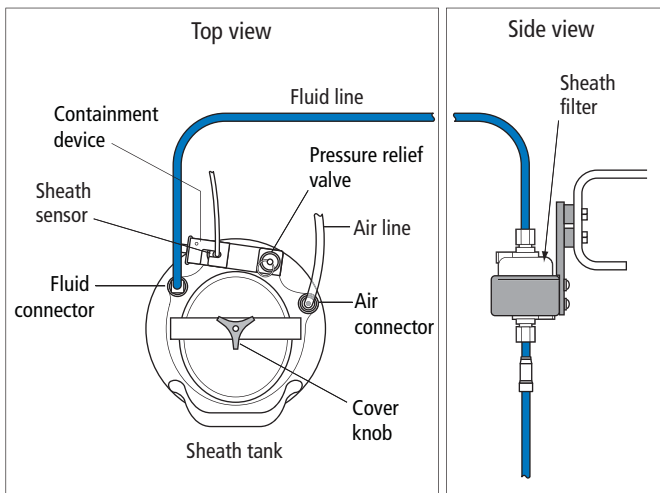

To refill the sheath tank:

- 1 Turn off the stream.
- 2 Disconnect the air line.
- 3 Pull up on the ring of the pressure relief valve to release pressure from the tank.
Make sure the tank is fully vented.
- 4 Unscrew the sheath tank cover knob and remove the cover.
- 5 Fill the tank with sheath fluid up to the upper weld line on the inside of the tank. See Figure 4-7 on page 128.

NOTE Do not overfill the sheath tank because this can cause incorrect sample flow rates.

Figure 4-7 Sheath tank fill level

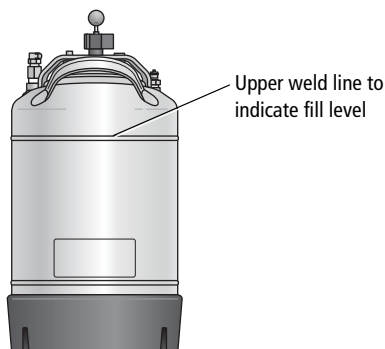

- 6 Replace the cover and tighten the knob.

Make sure the large O-ring on the inside lip of the cover is seated correctly and has not slipped out of position. The tank can leak if the cover is not secured properly.

- 7 If you removed the sheath tank to refill it, place the tank back in its original position. See Figure 4-8 on page 128.

The flow rate is calibrated with the sheath tank in the fluidics drawer. If the location or elevation of the sheath tank is changed, it could affect the flow rate calibration.

Figure 4-8 Sheath tank location label



- 8 Connect the air line.

- 9 Close the vent release valve and use the sheath tank gauge to ensure the tank is pressurizing properly.

The system is ready to run again.

Refilling the Ethanol Shutdown Tank

The fluid level in the stainless steel ethanol shutdown tank should be checked before starting the fluidics shutdown procedure and refilled when low. This tank does not have a sensor, so it must be checked manually.

Figure 4-9 Ethanol shutdown tank connectors

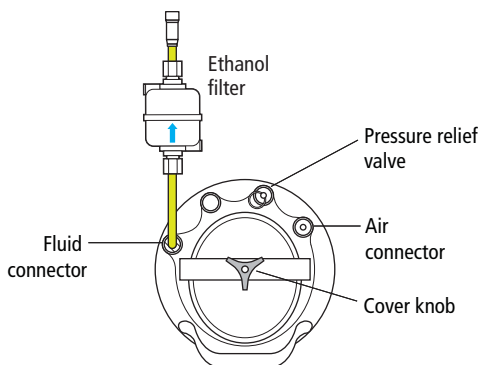

- 1 Turn off the stream.
- 2 If it is connected, disconnect the air line on the ethanol shutdown tank.
- 3 Pull up on the ring of the pressure relief valve to release pressure from the tank.

Make sure the tank is fully vented.

- 4 Unscrew the tank cover knob and remove the cover.
- 5 Fill the tank with ethanol to the level shown in Figure 4-10 on page 130.
- 6 Replace the cover and tighten the knob.

Make sure the large O-ring on the inside of the cover is seated correctly and has not slipped out of position. The tank can leak if the cover is not secured properly.

- 7 If you are going to perform fluidics shutdown, connect the air line.

Figure 4-10 Ethanol shutdown tank fill level

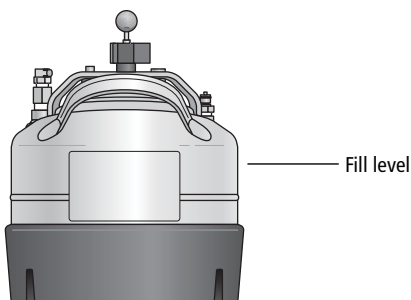

Refilling the Plastic Containers

You can refill the plastic containers directly in the fluidics drawer without detaching any lines, or you can remove the container for refilling. Note that during operation, you can add fluid to a container through the large cap without any interruption to your experiment, but if you detach any lines, you will need to prime the system.

- 1 (Optional) Disconnect the container's sensor and quick-release connector from the connectors panel if you need to move the container. (See Figure 4-11 on page 131.)

If you do not need to move the container, skip to step 2.

Figure 4-11 Plastic fluidics container

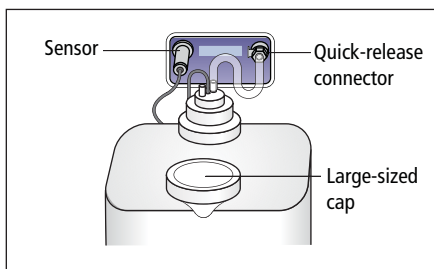

- 2 Remove the large-sized cap from the container (See Figure 4-11.)
- 3 Fill the container with the fluid indicated on the container label.
- 4 Replace the container cap and hand-tighten it until it is fully closed.
- 5 If you disconnected the sensor and quick-release connectors in step 1:
 - a Reconnect the sensor and quick-release connectors to their respective ports.





To ensure that the appropriate solutions are dispensed, do not switch the tank positions. Make sure the label on each container matches the labeled port on the fluidics drawer.

- b Prime the fluidics system.

From the BD FACSDiva menu bar, select **Cytometer > Cleaning Modes > Prime after Tank Refill**. In the dialog that opens, select the fluid to prime, then click **OK**.

Emptying the Waste Container

Empty the waste container daily and when the fluid indicator shows the waste is getting full. To prolong the life of the container, we recommend that you switch to the alternate container each time the waste is emptied.

  All biological specimens and materials coming into contact with them can transmit potentially fatal disease. To prevent exposure to biohazardous agents, expose waste container contents to bleach (10% of total volume) before disposal. Dispose of waste in accordance with local regulations. Use proper precautions and wear suitable protective clothing, eyewear, and gloves.



  Change the waste container cap every month, or when it has gotten wet, to prevent container pressurization. To order new replacement caps, contact your local BD Biosciences representative.



Figure 4-12 Waste container details

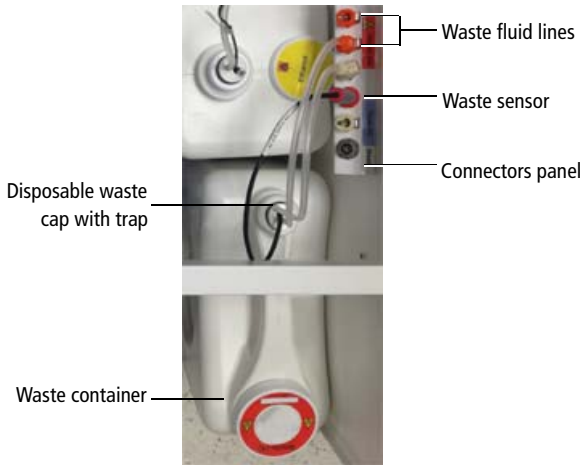
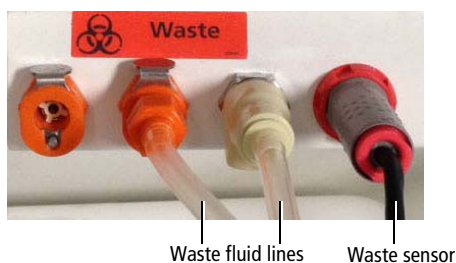

- 1 Disconnect the waste container's sensor and fluid line connectors from the connector panel in the fluidics drawer.

Figure 4-13 Waste section of connector's panel



  The waste container can become pressurized when the cytometer is running. Always disconnect the container from the connectors panel before you empty it. Wait at least 1 minute for pressure to dissipate before you open the container.

- 2 Remove the disposable waste cap (large-sized cap) and attached trap from the container. Place the assembly on the bench label-side up.



  Do not wet the cap on top of the trap. If you see liquid inside the trap, remove the drain plug and fully drain the liquid before you replace the plug (Figure 4-14).

Figure 4-14 Draining liquid from the trap



- 3 Empty the waste container according to your standard laboratory procedures for biohazardous waste.
- 4 Add approximately 1 L of bleach to the waste container (10-L container).

Add a sufficient amount so that 10% of the total waste volume is bleach.

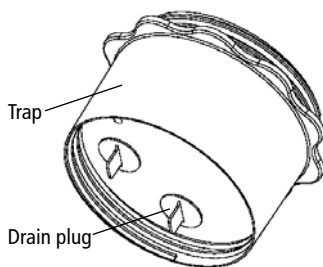
- 5 Replace the waste trap and attached filter cap. Hand-tighten the trap and cap until they are fully closed.



To prevent over-pressurization during fluidics startup, do not overtighten the trap or attached filter cap. Tighten each component only until it is hand-tight. Do not use sealants such as Teflon® tape or other adhesives.

- 6 If one month has passed since you last changed the cap, replace the filter cap with a new one. Write the date on the new cap as a reminder.

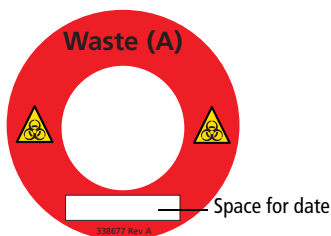

- 7 Reconnect the sensor and fluid line connectors to their respective ports.

Checking Cytometer Performance

Before setting up an experiment, you should first run a performance check. A performance check ensures that the cytometer is performing consistently over time. It also generates default cytometer settings that places each PMT within an optimal range.

NOTE You can also use the quality control process originally established for BD FACSDiva software. See the *BD Cytometer Setup and Tracking Application Guide*.

To run a performance check, start the CS&T application within BD FACSDiva software and select the appropriate cytometer configuration. Each configuration must have a valid baseline. See the *BD Cytometer Setup and Tracking Application Guide* for more information on running a baseline.

Preparing the CS&T Workspace

To ensure that your cytometer is performing consistently over time, it's important to keep as many variables constant as possible, such as bead type, sheath pressure, and cytometer settings. For this reason, you should run the daily performance check using the same cytometer configuration each day.

- 1 Turn off the Sweet Spot (if it is on), then select **Cytometer > CST**.

The cytometer disconnects from the BD FACSDiva interface and connects to the CS&T interface. A window similar to Figure 4-15 opens.

Figure 4-15 Main CS&T window

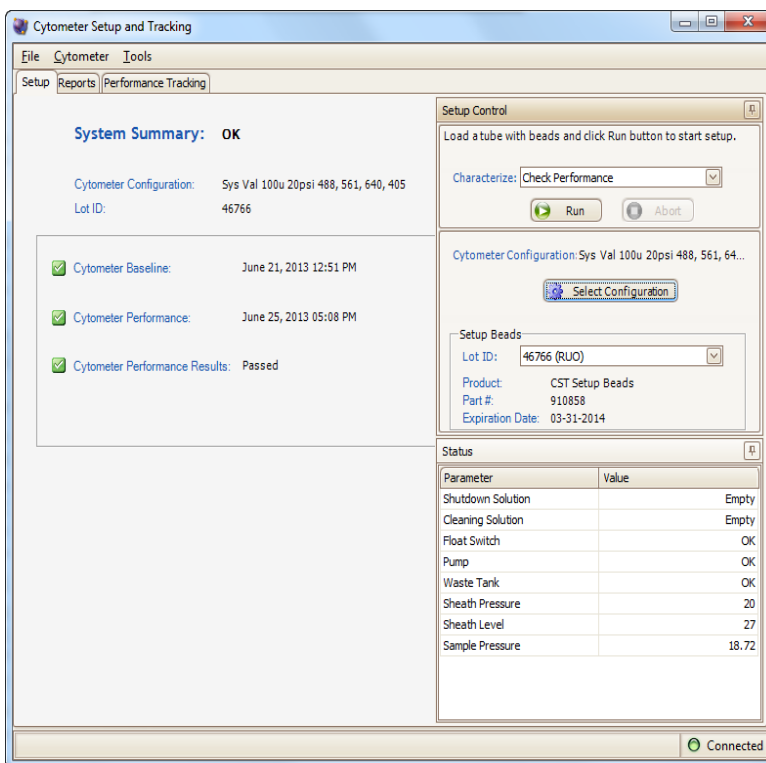

- 2 Verify that the bead lot information under **Setup Beads** matches the CS&T research bead lot.

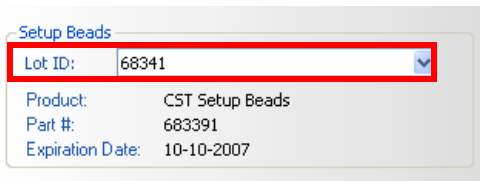

Select the correct lot ID from the menu. The bead lot ID number is located on the CS&T research bead vial.

- 3 Verify that the cytometer configuration is correct for your experiment.

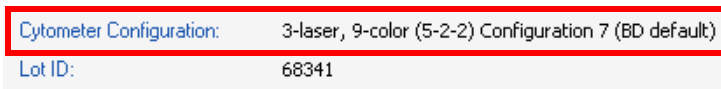

If the cytometer is not set to the correct configuration:

- a Click **Select Configuration** in the **Setup Control** window.

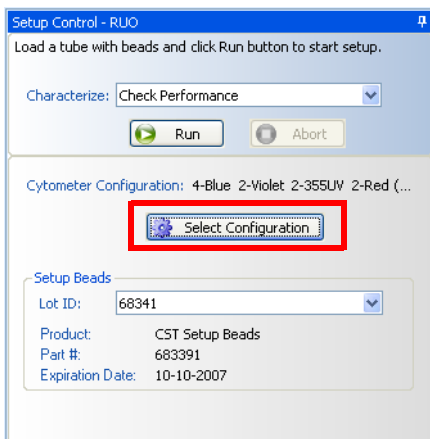

- b Select the correct configuration from the list.

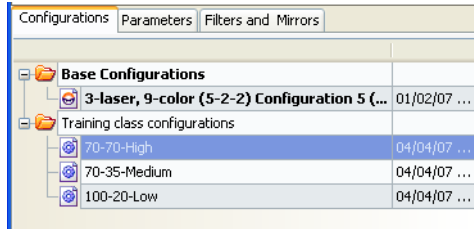

- c Click **Set Configuration**. Click **OK**.
- 4 Verify that the current configuration has a valid baseline defined.

If not, see the *BD Cytometer Setup and Tracking Application Guide* for more information on running a baseline.

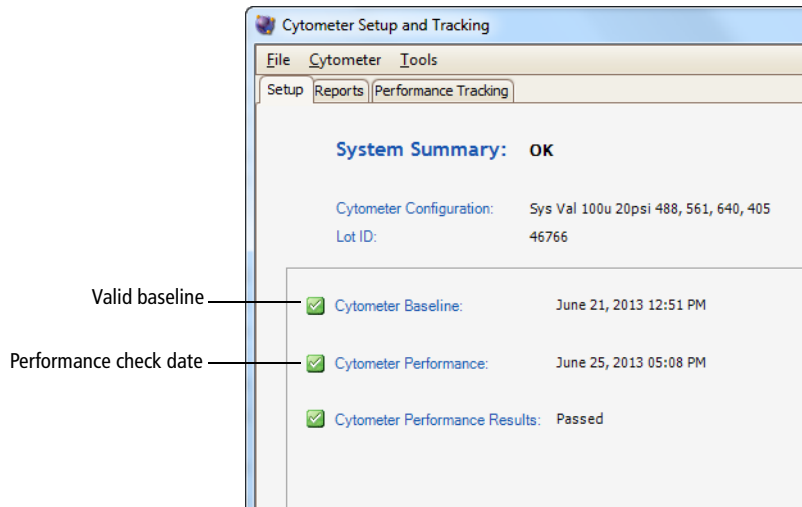

Preparing the BD FACSDiva CS&T Research Beads

BD FACSDiva CS&T research beads consist of bright, mid, and dim beads dyed with a mixture of fluorochromes. Use the beads to define a baseline and to check cytometer performance using the CS&T application.

See the BD FACSDiva CS&T research beads technical data sheet for instructions about preparing the bead suspension. Instructions vary based on the task you are performing.

Running a Performance Check

The performance check function of CS&T will check the cytometer's daily performance.

- 1 Install the bead tube onto the cytometer loading port.



Movement of mechanical parts within the instrument can pinch or injure your hands or fingers. Keep your hands and clothing away from the loading port when a tube is loading or unloading. Do not place objects underneath the loading port.

- 2 In the **Setup Control** window, select **Check Performance** from the **Characterize** menu.
- 3 Click **Run**.



Plots are displayed under the Setup tab and the performance check is run. The performance check takes approximately 5 minutes to complete.

Reviewing the Results

- 1 Once the performance check is complete, click **View Report**.
- 2 Print the report.
- 3 Verify that the performance check passed.

In the Setup tab, the Cytometer Performance Results should have a green checkmark and the word *Passed* next to it.

If any parameters did not pass, see the *BD Cytometer Setup and Tracking Application Guide* for troubleshooting information.

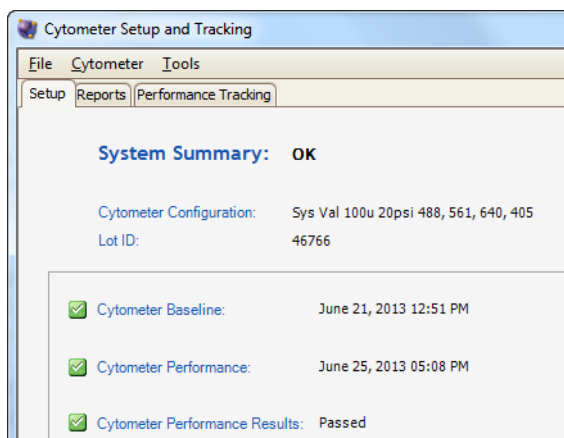

- 4 Select **File > Exit** to close the CS&T window and connect back to the BD FACSDiva interface.
- 5 Click **Use CST Settings** in the **CST Mismatch** dialog that opens.

See CST Mismatch Dialog on page 140 for more information.

When CS&T settings are applied to new experiments, the settings applied include PMT voltages, threshold, laser delays, and area scaling factors. (The window extension values are generated from the cytometer configuration.)

When CS&T settings are applied to existing experiments, the settings applied include PMT voltages, laser delays, area scaling factors, and window extensions. Threshold values remain the same.

NOTE There is a system preference to always use current CS&T settings that can be set by the administrator. For BD FACSAria Fusion users, we recommend that you do not enable this preference.

At this point you can do one of the following:

- Create application settings for an experiment you will use frequently. See Application Settings on page 141.
- Collect data using existing application settings. See Data Collection on page 148.

CST Mismatch Dialog

If there is a mismatch between the CS&T settings and those in BD FACSDiva software, a dialog opens (Figure 4-16) to indicate what the differences are, and gives you the following options:

- **Use CST Settings.** Select this option if you want to use the settings generated from the most recent performance check.
- **Keep BD FACSDiva Settings.** Select this option if you want to keep the settings that are associated with your cytometer.
- **Details.** Click this button to view the differences between the two settings to help with your selection.

Figure 4-16 CST Mismatch dialog

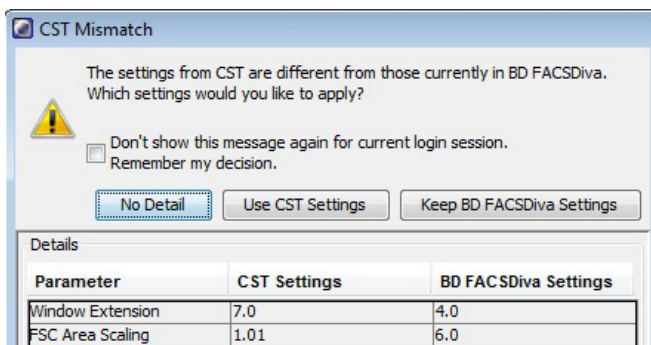

- See Data Collection on page 148.

Application Settings

Application settings are associated with a cytometer configuration and include the parameters needed for the application, area scaling values, PMT voltages, and threshold values, but not compensation. Each time a performance check is run for a configuration, the application settings associated with that configuration are updated in the catalog. To update the application settings in an existing experiment, right-click the application settings in the Browser and select **Application Settings > Apply**.

Using application settings provides an easy, consistent, and reproducible way to reuse cytometer settings for your commonly used applications. See the *BD Cytometer Setup and Tracking Application Guide* for information on running a baseline and for other details on using the CS&T application.

Before creating application settings you must:

- Perform the cytometer startup procedure described in Cytometer Startup on page 116.
- Run a performance check for the cytometer configuration that will be used for the application.

Creating Application Settings

This section describes how to create and save application settings for a multi-color immunophenotyping sample.

Setting Up the Workspace

- 1 Select **Cytometer > View Configurations**, and verify that the current configuration is appropriate for the type of sample you are running.
- 2 Verify that there is a valid performance check for the configuration.
- 3 Create a new folder.
- 4 Create a new experiment.
- 5 Select the **Cytometer Settings** in the Browser.
- 6 In the **Inspector** window, click the **Parameters** tab and delete any unneeded parameters.
- 7 Select the **H** check box to select height for each parameter.

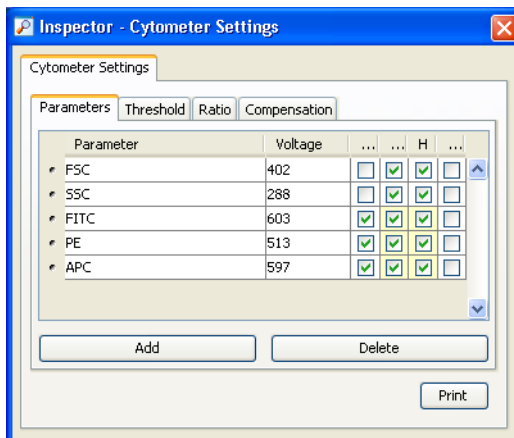

Adjusting Area Scaling

The required area scaling factor changes based on sheath pressure and particle size. The area scaling factors should be verified for each experiment performed on the cytometer.

NOTE You will need to modify the template to support the lasers installed on your system. Don't forget to save the settings when you are done.

- 1 In the **Browser**, right-click **Global Sheet1** and select **Apply Analysis Template**.
- 2 In the **Template** dialog, select the **Area Scaling** worksheet and click **OK**.
- 3 Create a new specimen by clicking the **New Specimen** button on the **Browser** toolbar.
- 4 Expand the new specimen, then click to set the current tube pointer to **Tube_001**.
- 5 Install the FITC-positive control tube onto the loading port and click **Load** on the **Acquisition Dashboard**.



Movement of mechanical parts within the instrument can pinch or injure your hands or fingers. Keep your hands and clothing away from the loading port when a tube is loading or unloading. Do not place objects underneath the loading port.

- 6 Adjust the FSC and SSC voltages to place the particles on scale.

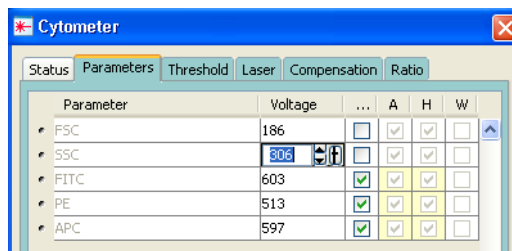

- 7 Adjust the P1 gate around the population of interest in the FSC vs SSC plot.

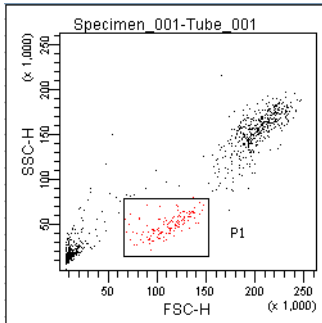

- 8 Adjust the FSC area scaling.

- a Click the Laser tab in the Cytometer window.

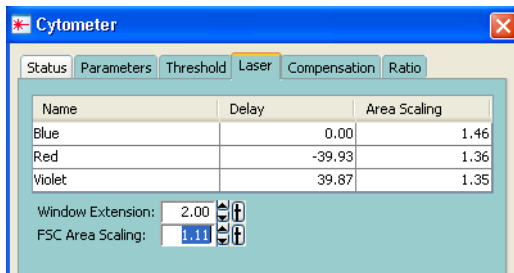

- b Adjust the FSC area scaling factor until the FSC-A signal matches the FSC-H signal. See Figure 4-17 on page 145.

- Increase the area scaling factor if the FSC-A signal is lower than FSC-H.
- Decrease the area scaling factor if the FSC-A signal is higher than FSC-H.

- c View the result of your change in the histograms and statistics views.

Figure 4-17 FSC area scaling comparison

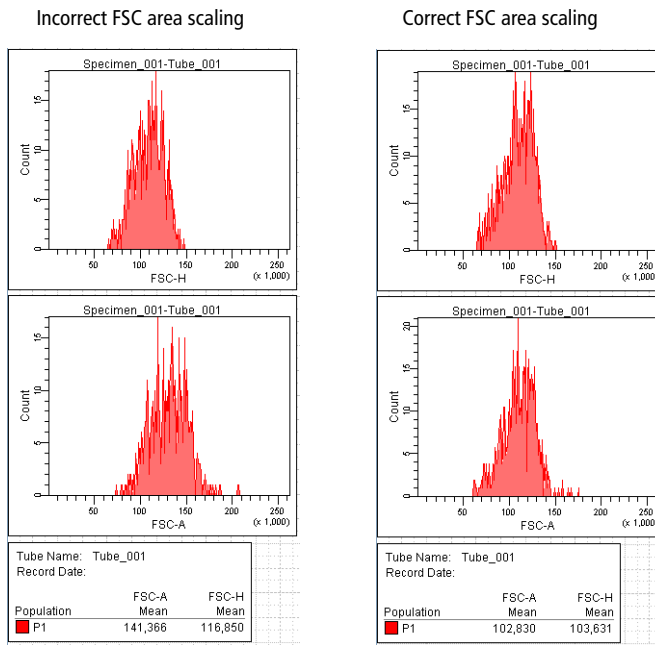

- 9 Adjust the blue laser area scaling until the FITC-A signal matches the FITC-H signal, if needed.
 - 10 Unload the FITC-positive control tube, then load the APC-positive control tube.
 - 11 Adjust the red laser area scaling until the APC-A signal matches the APC-H signal, if needed.
 - 12 Check and adjust, as necessary, the area scaling for the remaining lasers using a single color stained tube.
- Only one parameter from each laser needs to be used for area scaling.
- 13 In the **Inspector** window, clear the checkboxes for height for all parameters. See Figure 4-18 on page 146.

Figure 4-18 Inspector window

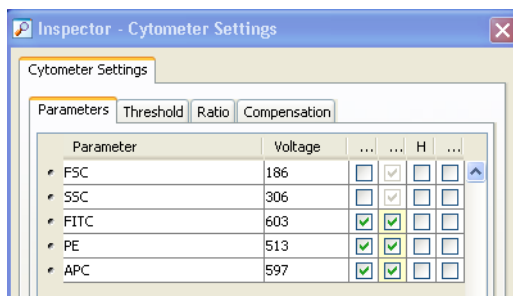

Optimizing PMT Voltages

- 1 Right-click Cytometer Settings in the Browser, then select **Application Settings > Create Worksheet**.

A second global sheet is added with the plots created according to your selections in the Parameters tab. (See Figure 4-19.) Use the gray boxes and crosshairs to guide your optimization.

NOTE The gray boxes and crosshairs are not displayed until acquisition starts.

Figure 4-19 Optimizing PMT voltages

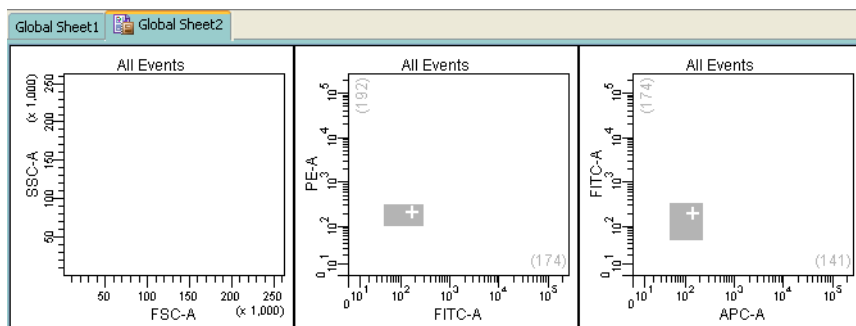

- 2 Load a multicolor sample tube onto the cytometer.
- 3 In the Cytometer window, optimize the settings for your application.

Data Collection

Before you record data for a sample, cytometer settings should be optimized to position the cells of interest on scale for scatter and fluorescence parameters. In the previous section, application settings were created by taking into consideration the following:

- FSC and fluorescence area scaling
- FSC and SSC voltages
- FSC threshold
- Fluorescence PMT voltages

In this section, the application settings will be applied and compensation will be calculated before collecting test data.

The following sections describe how to use previously optimized application settings for a 4-color experiment. See Application Settings on page 141 for more information.

Compensation will be automatically calculated using the compensation setup feature. For more information about this function, see the *BD FACSDiva Software Reference Manual*. If you are performing compensation manually, not all steps will apply.

Setting Up the Workspace

Before you begin optimizing settings, it is important to verify the cytometer configuration and create an experiment containing appropriate parameters for the assay.





- 1** Select **Cytometer > View Configurations**, and verify that the current configuration is appropriate for the type of sample you are running.
- 2** Verify that there is a valid performance check for the configuration.

- 3 Make sure that the octagon(s) contain appropriate filters.

For assistance, see Cytometer Configuration on page 87.



For accurate data results, the cytometer optics must match the current cytometer configuration.

- 4 Click the corresponding buttons on the Workspace toolbar to display the Browser () , Cytometer () , Inspector () , Worksheet () , and Acquisition Dashboard () windows, as needed.

- 5 (Optional) Create a folder for your experiment.

Select the icon for your database and press Ctrl+N. Rename the folder appropriately. See the *BD FACSDiva Software Reference Manual* for ideas on how to organize experiments.



Tip To place an experiment inside a folder, select the folder *before* you create the experiment.

- 6 Create an experiment from the Doublet Discrimination Gating template. See Figure 4-21 on page 150.

For best results, we recommend that you perform doublet discrimination in order to record only singlet events. This template contains cytometer settings and gated plots for this purpose. A procedure is given in Recording Data on page 159.

Figure 4-21 Experiment created from the Doublet Discrimination Gating template

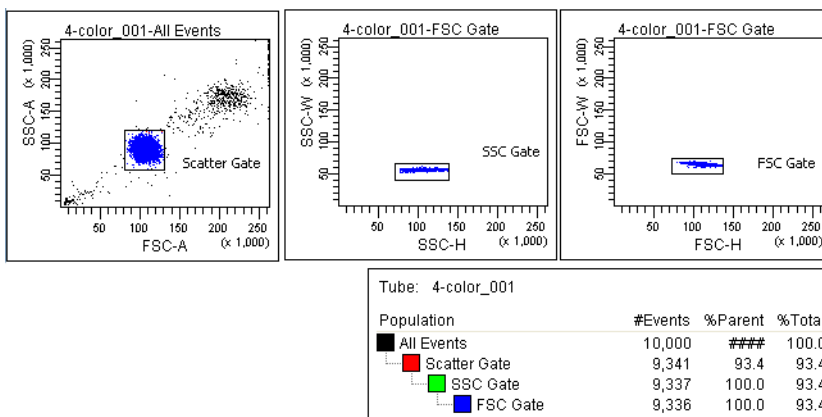

To use the template, select **Experiment > New Experiment** and select the **Doublet Discrimination Gating** template. Click **OK** to add a copy of the template to the Browser.

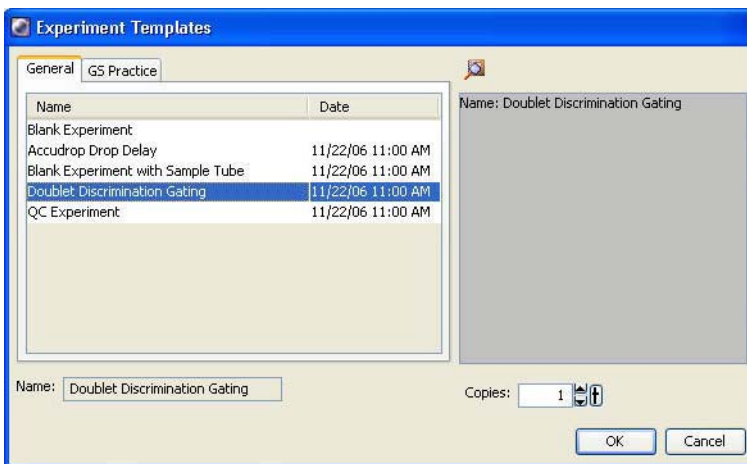

- 7 Rename the experiment appropriately (for example, *4-Color experiment*).
- 8 Right-click the experiment level **Cytometer Settings** in the Browser and select **Apply Application Settings**. See Figure 4-22 on page 151.

Figure 4-22 Application Settings window

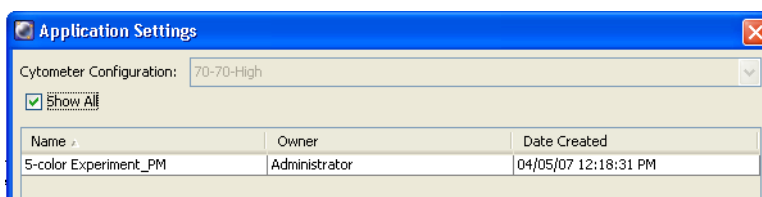

See Application Settings on page 141 for instructions on creating application settings.

- 9 Select the application setting for your sample and click **Apply**.

See Figure 4-23 for a typical error message if there are any mismatches between the application and cytometer settings.

Figure 4-23 Example mismatch error message

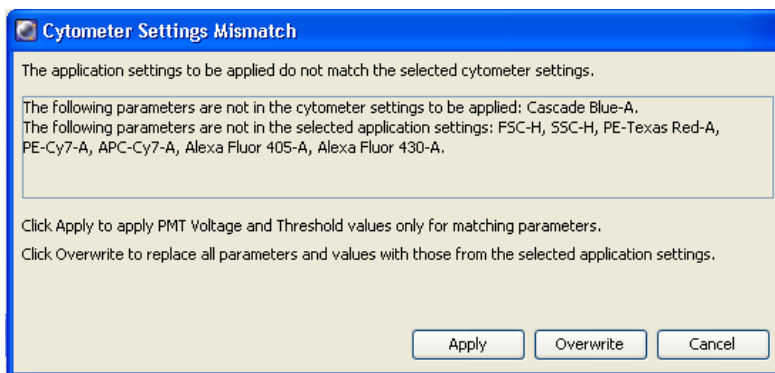

- 10 Select **Experiment > Compensation Setup > Create Compensation Controls**.

The Create Compensation Controls dialog opens, listing only those parameters associated with the application settings.

- 11 Click **OK** to add the specified controls.

Alternatively, add and define label-specific controls, then click **OK**.

Figure 4-24 Create Compensation Controls dialog

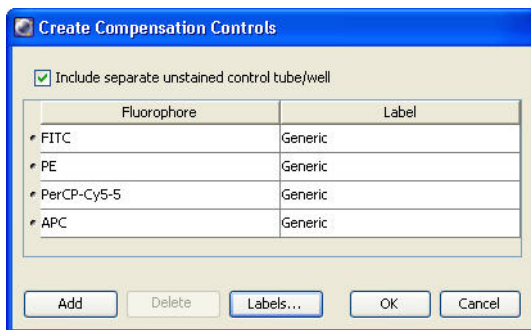

Add label-specific controls when your experiment contains samples stained with the same fluorophore conjugated to different antibodies (labels) that require different compensation values. This is especially useful with tandem conjugates due to lot-to-lot variation. See the *BD FACSDiva Software Reference Manual* for more information about this function.

A compensation specimen is added to the experiment, along with a stained control tube for each compensation control. (Expand the specimen to view all tubes.) Worksheets containing appropriate plots are added for each compensation tube.

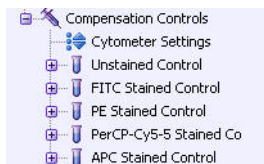

Calculating Compensation

The unstained control will be used to verify the settings for FSC, SSC, and FSC threshold, and to gate the population of interest.

- 1 Install the unstained control tube onto the cytometer.
- 2 Expand the compensation specimen in the **Browser**.

- 3 Set the current tube pointer to the unstained control tube and click **Load**.



Movement of mechanical parts within the instrument can pinch or injure your hands or fingers. Keep your hands and clothing away from the loading port when a tube is loading or unloading. Do not place objects underneath the loading port.

- 4 Verify that the population of interest is displayed appropriately on the FSC vs SSC plot. Adjust if needed. (See Figure 4-25.)

Since the application settings have already been optimized for your sample, the cytometer settings should require little or no adjustment (unless you are using BD™ CompBead particles).

Figure 4-25 Voltages adjusted

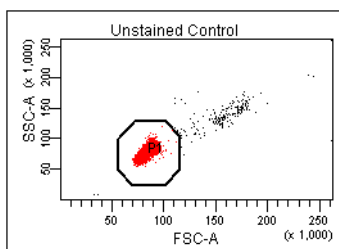

- 5 Click the **Threshold** tab and adjust the FSC threshold, if needed.

Set the threshold to remove most of the debris without cutting off the singlet population (Figure 4-25).

- 6 Adjust the P1 gate to surround only the singlets (Figure 4-25).
- 7 Right-click the P1 gate and select **Apply to All Compensation Controls**.

The P1 gate on each stained control worksheet is updated with your changes.

- 8 Click **Record Data**.

- 9 When recording is finished, click **Unload** and remove the unstained control tube from the cytometer.



Do not change the PMT voltages after the first compensation control has been recorded. In order to calculate compensation, all controls must be recorded with the same PMT voltage settings. If you need to adjust the PMT voltage for a subsequent compensation control, you will need to record all compensation controls again.

- 10 Install the next tube onto the cytometer and repeat steps 8 and 9 until data for all stained control tubes has been recorded.
- 11 Double-click the first stained control tube to display the corresponding worksheet.
- 12 Verify that the snap-to interval gate encompasses the positive population. Adjust the gate, if needed.

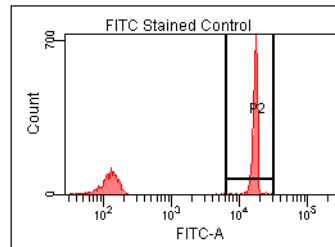
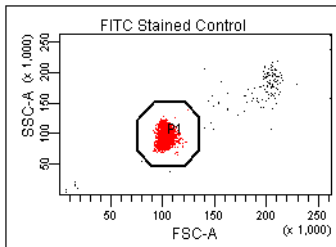

- 13 Repeat steps 11 and 12 for the remaining compensation tubes.
- 14 Select **Experiment > Compensation Setup > Calculate Compensation**.
- 15 Enter the name of your experiment as the setup name, then click **Link & Save**.

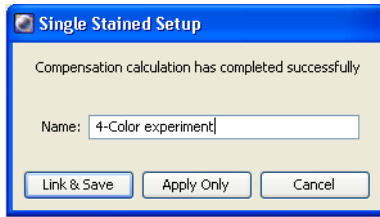

Tip To keep track of compensation setups, include the experiment name, date, or both in the setup name.

NOTE We recommend that you always visually and statistically inspect automatically calculated overlap values. The means of the positive controls should be aligned with the means of the negative.

Data Recording and Analysis

Once you have optimized the cytometer electronics for your sample type, you are ready to record and analyze data.

Before you record data, we recommend that you gate out doublets in order to record only singlet events. The Doublet Discrimination Gating template provides gated plots for this purpose.

During analysis, recorded data is displayed in plots, and gates are used to define populations of interest. BD FACSDiva software analyzes the gated data and calculates statistics that you can print or export. With global worksheets, data can be shown for a series of tubes on the same worksheet, manually or in an automated batch analysis.

The following sections describe how to use BD FACSDiva software features to record and analyze sample data.

Setting Up the Experiment

Before you record data, set up an experiment with appropriate tubes, plots, and labels for your assay. This section describes how to add Browser and worksheet elements to the experiment that was started in the previous section, Data Collection.

- 1** Rename **Specimen_001** to a descriptive name.
- 2** Rename **Tube_001** to *4-color_001*.
- 3** Set the current tube pointer to the **4-color_001** tube.
- 4** Click **Next Tube** in the **Acquisition Dashboard** to duplicate the first tube with the name *4-color_002*.
- 5** Use the experiment layout to specify the number of events to record for each tube.

The experiment layout can be used to define the events to record as well as parameter labels for all tubes in an experiment. Labels are displayed on the plot axes and in all statistics views.

- a** Select **Experiment > Experiment Layout**.
- b** In the **Acquisition** tab, select the events to record field for all specimen tubes, and select or enter *5,000* events.
- c** Click **OK**.

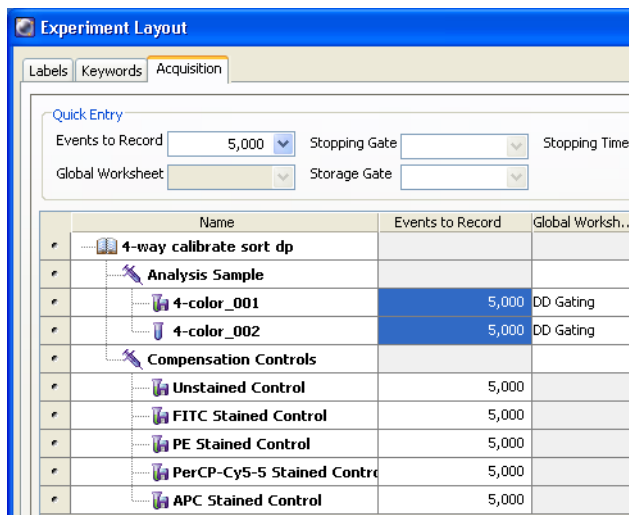

Setting Up the Global Worksheet

A global worksheet is used to perform doublet discrimination and to set up plots to preview and record data.

- 1 Click the **Worksheets View** button on the **Worksheet** toolbar.

The global worksheet is shown. If you are using the Doublet Discrimination Gating template, the worksheet shows the predefined plots and gates used to distinguish singlets from doublets.

The second and third plots are set up to display gated data from the first and second plots, respectively, as shown in the population hierarchy.

- 2 Create two dot plots for previewing and recording data.

For this example, create a FITC vs PE plot and an APC vs PerCP-CyTM5.5 plot.

- Tip** Double-click the **Plot** button to keep it selected until you create all plots. Click any other button to undo the selection.

- 3 Turn on biexponential display.
 - a Select the two plots.
 - b In the **Inspector**, select the checkbox for **X Axis** and **Y Axis** under **Biexponential Display**.

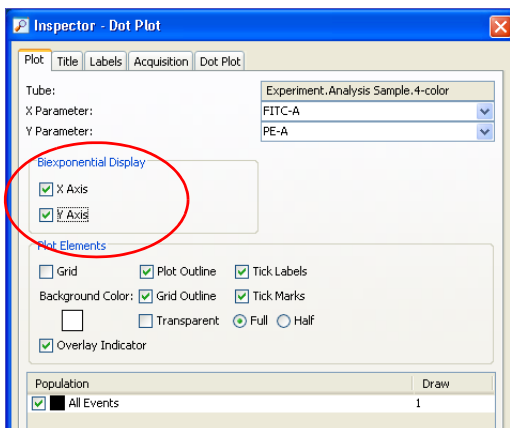

- 4 Set up the fluorescence plots to display data from the FSC gate.

The FSC gate defines singlet events. By gating the fluorescence plots through this population, only singlet events will be recorded.

- a Select the two plots.
 - b In the **Inspector**, select the **FSC Gate** checkbox.
- 5 Arrange the fluorescence plots so they fill the page vertically.

For an example, see Figure 4-27 on page 162.

Recording Data

This section describes how to adjust the gates to eliminate doublets and record singlet events.

- 1 Move the current tube pointer to the **4-color_001** tube.
- 2 Install the first mixed sample tube onto the loading port and click **Load**.



Movement of mechanical parts within the instrument can pinch or injure your hands or fingers. Keep your hands and clothing away from the loading port when a tube is loading or unloading. Do not place objects underneath the loading port.

- 3 Change the **Events to Display** to 5,000 events.
- 4 Adjust the scatter gate to encompass the singlet events.
- 5 Adjust the SSC gate to encompass the low SSC-W population.
- 6 Adjust the FSC gate to encompass the low FSC-W population.

Figure 4-26 Discriminating singlet events

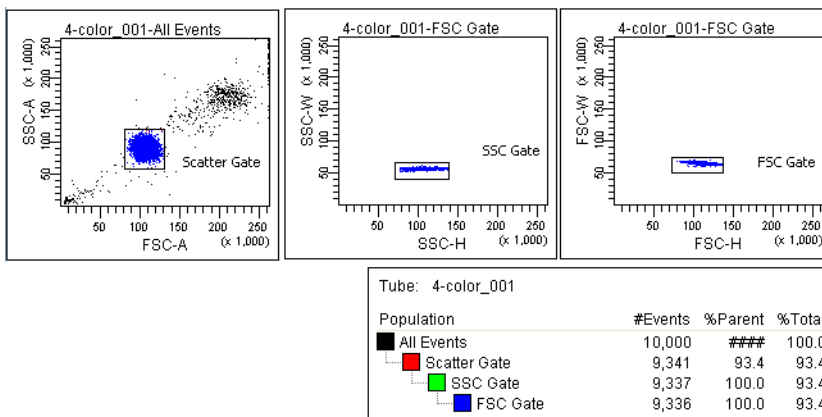

- 7 Click **Record** in the **Acquisition Dashboard** to record data.

- 8 When all events have been recorded, click **Unload** and remove the tube from the cytometer.
- 9 Install the next tube, then click **Next Tube** in the **Acquisition Dashboard** to move the current tube pointer to the next tube.
- 10 Repeat steps 7 through 9 for the remaining tubes.

Analyzing Data

This section describes how to set up plots, gates, and a statistics view to analyze the recorded data. By the end of this section, your analysis should look similar to that shown in Figure 4-27 on page 162.

- 1 Select **Edit > User Preferences**.
- 2 In the **Gates** tab, set the preferences as follows.



- 3 Create the following gates:
 - Quadrant gate on the FITC vs PE plot.
 - Interval gate on the APC vs PerCP-Cy5.5 plot to capture the APC beads.
 - Rectangle gate on the APC vs PerCP-Cy5.5 plot to capture the PerCP-Cy5.5 beads.

- 4 Rename each population in the population hierarchy.
 Tip Press the Enter key twice to move to the next population without using the mouse.
- 5 Right-click either fluorescence plot and select **Create Statistics View**.
A statistics view is added to the worksheet.
- 6 Right-click the statistics view and select **Edit Statistics View**.
- 7 Edit the statistics view as follows:
 - In the **Header** tab, select the **Use 2 columns for display** checkbox.
 - In the **Populations** tab, clear the checkboxes for all populations except FITC, PE, PerCP-Cy5.5, and APC.
 - In the **Statistics** tab, select the **Mean** checkboxes for the fluorescence-A parameters.
- 8 Resize the statistics view so it fits on the page.
- 9 (Optional) Print the analysis.

Figure 4-27 Sample analysis for mixed-bead tube

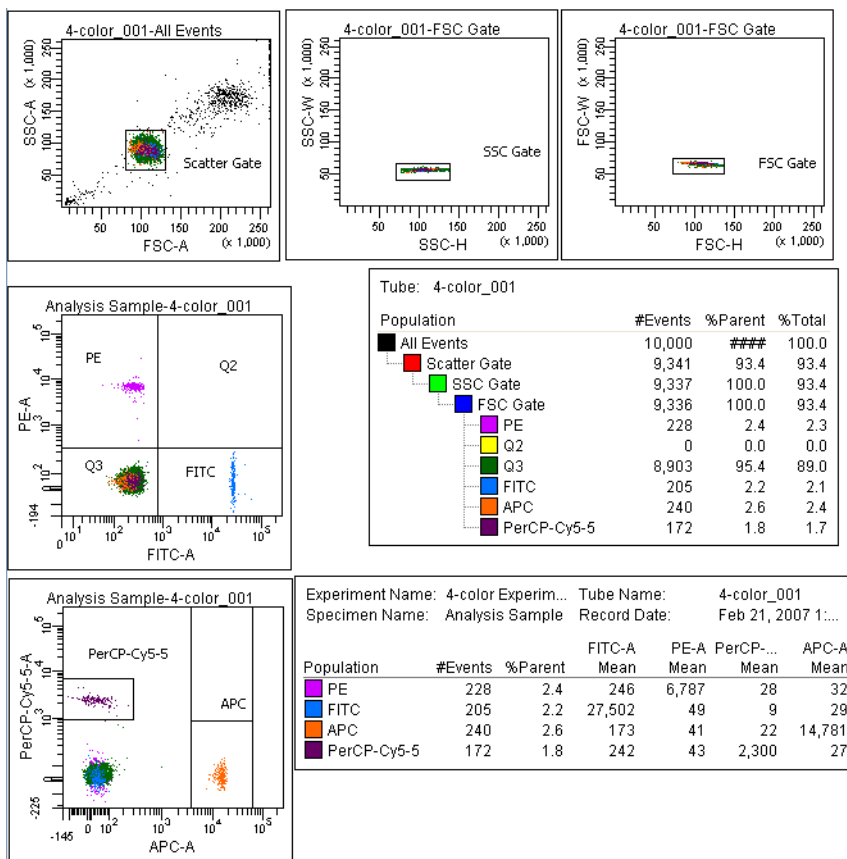

Performing a Batch Analysis

Batch analysis allows you to automatically advance through a selected set of tube data when using a global worksheet.

To perform a batch analysis:

- 1 Verify that the global worksheet you will be using for analysis is displayed in the worksheet window.

- 2 Right-click the specimen to analyze in the **Browser** and select **Batch Analysis**.

The Batch Analysis dialog opens.

Only tubes under the selected specimen will be processed. Tubes without data are skipped during a batch analysis.

- 3 Do the following in the **Batch Analysis** dialog.

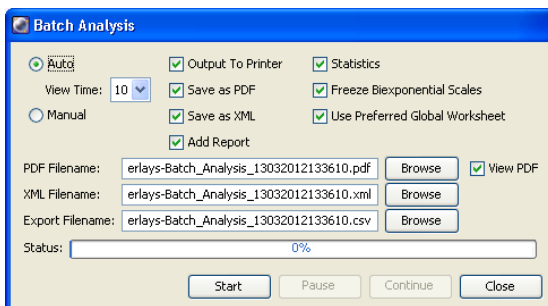

- Select **Auto** to analyze all the files without user intervention.
- Select **5** from the **View Time** menu to pause the analysis for 5 seconds after each tube is loaded.
- Select the **Output to Printer** checkbox to print a copy of the analysis after the data for each tube is loaded.
- Select the **Statistics** checkbox to export the statistics to a separate file, then enter a name for the statistics file. By default, the file is saved at D:\BDEExport\Statistics.
- Select the **Freeze Biexponential Scales** checkbox to process all files with the same biexponential scales.
- Clear the **Use Preferred Global Worksheet** checkbox to display analyses of tubes within the same global worksheets. This option is useful for analyzing panels that require a separate global worksheet for each tube.

See the *BD FACSDiva Software Reference Manual* for more information on batch analysis.

- 4 Click **Start** to begin the analysis.

When the analysis is finished, a completion dialog opens.

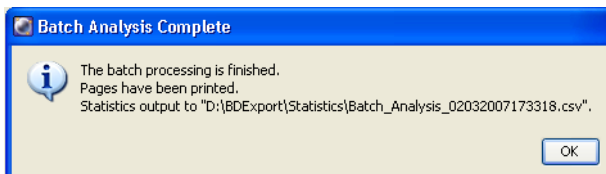

Manual Adjustment of Laser Delay

Laser delay is automatically adjusted during performance checks. However, you may want to adjust laser delay manually, for example, when changing sheath pressure.

In a BD FACSAria Fusion system with red, blue, and violet lasers, the red laser intercepts the stream first, followed by the blue and violet lasers, respectively. Because the laser signals are spatially separated, there is a slight delay between the detection of each laser's signal.

The laser-delay factor in BD FACSDiva software is used to realign the signals so they can be measured and displayed on the same time scale. Signals are aligned with respect to the blue laser, so the blue laser will have a 0 delay value, the red laser will have a negative delay value, and the violet laser will have a positive delay value.

To manually adjust the delay:

- 1 Select your experiment folder in the **Browser** and create a new experiment.
- 2 Rename the experiment *Laser Delay*.
- 3 Create a specimen and a tube in the experiment and set the current tube pointer next to the tube.

- 4 On the global worksheet, create a plot for FSC vs SSC and then histograms for each laser.
- 5 Create a P1 gate on the FSC vs SSC plot and change the histograms to view P1.
- 6 Prepare a tube of Spherotech™ Rainbow beads.

BD FACFlow Solution	Spherotech Rainbow Particles (3.0–3.4 μm)	Ordering Info
1 mL	2 to 3 drops	Cat. No. 556291

- 7 Load the tube of Spherotech Rainbow beads and click **Load**.



Movement of mechanical parts within the instrument can pinch or injure your hands or fingers. Keep your hands and clothing away from the loading port when a tube is loading or unloading. Do not place objects underneath the loading port.

- 8 Place the population on scale in the FSC vs SSC plot.
- 9 Adjust P1 to encompass the singlet population, if needed.

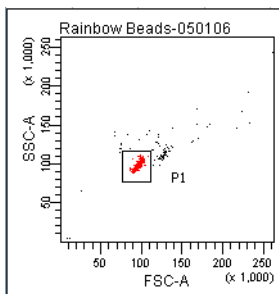

- a Optimize the delay setting for the red laser.

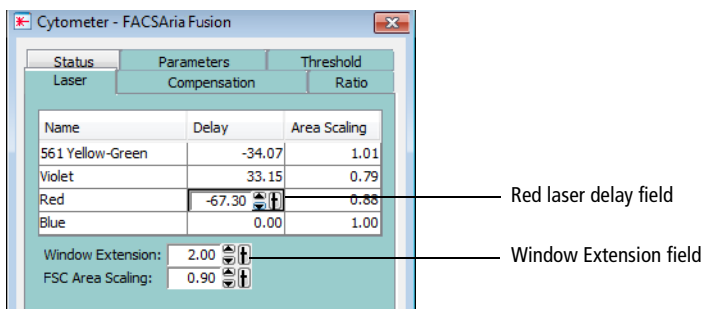

- b** Click the **Laser** tab in the **Cytometer** window.
- c** While watching the peak in the APC-A histogram, change the window extension to 0.
 - If the APC-A signal stayed the same or had little change, then go to step d.
 - If the APC-A signal decreased, then follow steps c through d.
- d** Adjust the laser-delay value until the maximum APC-A signal is achieved.

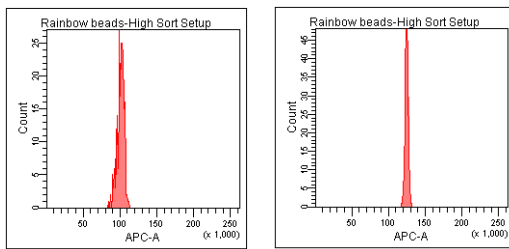

- e** Reset the window extension to the appropriate setting (typically 2).
- 10** Repeat step a for each laser, using the appropriate fluorochrome for each laser.
- 11** (Optional) To return to the laser delay values determined by CS&T, right-click the cytometer settings in the **Browser** and select **Apply CST Settings**.

- 12** (Optional) To save this worksheet for future use, export it as an analysis template.
 - a** Right-click the global worksheet in the **Browser**.
 - b** Select **Export > Analysis Template**.
 - c** Name the template *Laser Delay Plots* and click **Save**.

THIS PAGE INTENTIONALLY LEFT BLANK

5

Sorting

You can program BD FACSDiva software to sort a specified number of particles from multiple populations into a variety of sorting devices including tubes, plates, and slides. Hardware for sorting into plates and slides is available as an option. Up to four defined populations can be sorted into each tube, allowing up to 16 populations to be sorted at one time.

The following topics are covered in this chapter:

- Setting Up for Sorting on page 170
- Determining the Drop Delay – Manual Method on page 176
- Determining the Drop Delay – Automatic Method on page 181
- Sorting on page 183
- Setting Up for Sorting onto a Plate or Slide on page 192
- Index Sorting on page 199
- Terasaki Plate Adapter on page 203

Setting Up for Sorting

In general, do the following to set up for a sorting experiment. Each step is explained in more detail in previous or subsequent sections.

- 1 Start up the cytometer and the computer.

See Cytometer Startup on page 116.

- 2 Install the appropriate size nozzle.

- 3 Select a new sort setup mode, if needed, and select an appropriate cytometer configuration.

To change your current sort setup mode, select a nozzle size from the **Sort > Sort Setup** menu.

For more information, see Sort Setup on page 103.

- 4 Install a sample line filter, if needed.

See Installing or Removing a Sample Line Filter on page 239.

- 5 Check the laser delay for your sheath pressure and particle size.

- To set the laser delay automatically using the CS&T module, see Checking Cytometer Performance on page 134.
- To set the laser delay manually, see Manual Adjustment of Laser Delay on page 164.

- 6 If you have the AMO, turn it on at 20%.

See Operating the BD Aerosol Management Option on page 306.

- 7 Optimize cytometer settings for the sample to be sorted.

See Data Collection on page 148.

- 8** Install the required collection device and set up the side streams.

See Setting Up for Bulk Sorting on page 171 or Setting Up for Sorting onto a Plate or Slide on page 192.
- 9** Calculate the drop delay.



See Determining the Drop Delay – Manual Method on page 176.
- 10** Use gating tools and subsetting methods to define the population(s) of interest.

Examples of gating analyses can be found in Analyzing Data on page 160.
- 11** Define a sort layout for the tube containing the defined sort populations and proceed with sorting.

See Sorting on page 183.

Setting Up for Bulk Sorting

This section describes how to set up the streams for two- or four-way sorting. For sorting using the ACDU option, see Setting Up for Sorting onto a Plate or Slide on page 192.



  Any cytometer surface that comes in contact with biological specimens can transmit potentially fatal disease. Use universal precautions when handling sorting hardware. Wear suitable protective clothing and gloves.

To set up for bulk sorting:

- 1** Install collection tubes in the appropriate collection device.

Collection tube holders are available for 1-mL microtubes, 1.5-mL Eppendorf® tubes, 12 x 75-mm tubes, and 15-mL centrifuge tubes. For compatible tubes, see Labware on page 284.
- 2** Install the collection tube holder onto the cytometer.

- a Close the sort block door and open the sort collection chamber door, if needed. The sort block door must be closed to install the tube holder.
- b Slide the holder into the slotted fittings below the sort aspirator drawer, then close the sort collection chamber door.

  Before installing the collection tube holder, ensure that an O-ring is installed in the groove between the two sections of the tube holder. The O-ring minimizes the chance of aerosols escaping. It can be found in the accessory kit (Catalog No. 337897).

3 Turn on the deflection plates.

Click the **Voltage** button in the **Side Stream** window (Figure 5-1 on page 172). The voltage warning light illuminates, indicating that the plates are charged.



  A 12,000-volt potential exists between the deflection plates when they are on. Contact with the charged plates results in serious electrical shock. Do not touch the deflection plates when the plate voltage is on. The plates remain energized even when the sort block door is open.

Figure 5-1 Turning on the deflection plates



Make sure the center stream image does not move after the plates are turned on. Major movement of the center stream could indicate that the plates or the area around the plates needs cleaning.

- 4 Click the **Test Sort** button and optimize the side streams. See Figure 5-2.

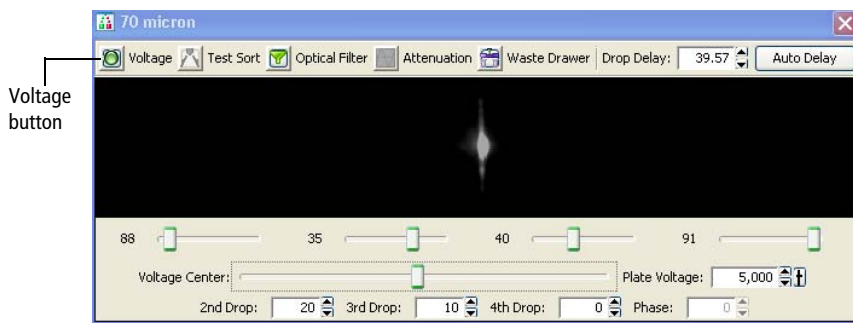
Adjust the voltage sliders to view the required number of streams.

Figure 5-2 Turning on Test Sort

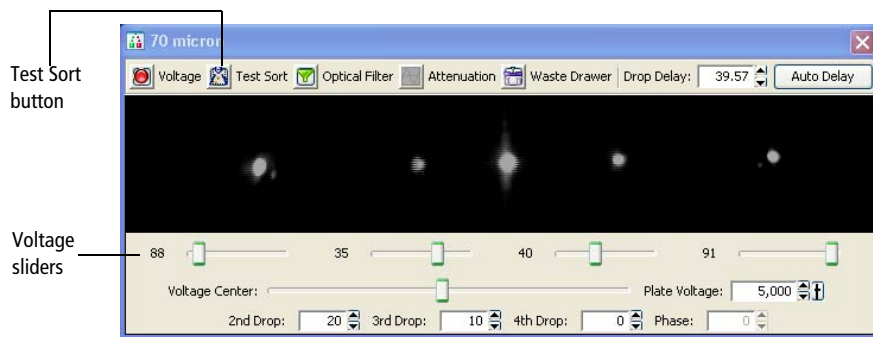

If you cannot see a stream image or the image is dim, adjust the micrometer dial on the diode laser to better view the streams (Figure 1-22 on page 42).

- 5 Adjust the 2nd, 3rd, and 4th Drop settings to tighten the center stream and fine-tune the side streams, if needed.

Generally, the sort setup mode provides good starting values for these settings. Adjust the values only if needed to optimize the streams.

- 6 Open the aspirator drawer and aim the side stream(s) into each collection tube.
 - a In the **Side Stream** window, click the **Waste Drawer** button to open the drawer.
 - b Open the sort block door and aim each side stream into the tube as you adjust the corresponding slider in the **Side Stream** window.
 - c When you are satisfied with the side stream deflection, close the sort block door.
- 7 Click the **Voltage** button to turn off the deflection plates.

8 Optimize the drop delay.

See one of the following procedures:

- Determining the Drop Delay – Manual Method on page 176
- Determining the Drop Delay – Automatic Method on page 181

Using the 1.5-mL Side Stream Alignment Tool

If you are using 1.5-mL Eppendorf tubes, use the 1.5-mL side stream alignment tool to align the side streams and verify drop placement.

- 1** Set the optimal breakoff.
- 2** Ensure that the center stream is aligned with the center of the aspirator drawer.
- 3** With the aspirator drawer closed (retracted), position the alignment tool in the sort block as shown.

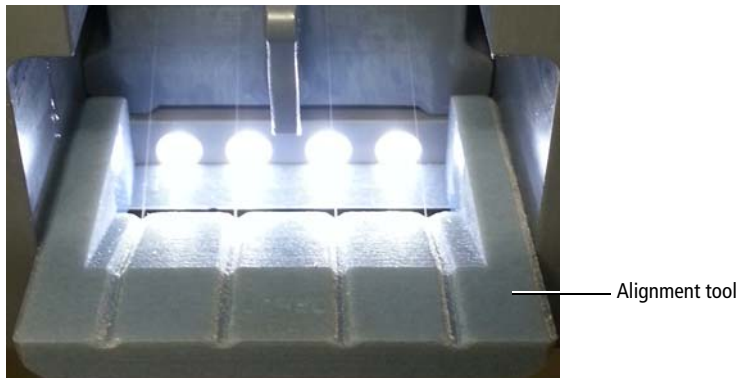

- 4** Turn on the deflection plates.
- 5** Click **Test Sort**, then adjust sliders to align each side stream to the corresponding notch on the alignment tool.

Tip Place a wipe or paper towel inside the sample collection chamber to prevent the stream fluid from pooling or splashing.

- 6 Turn off the deflection plates.
- 7 Carefully remove the alignment tool.
- 8 To verify stream alignment, place four capped Eppendorf tubes inside the Eppendorf collection tube holder and insert the tube holder into the sort collection chamber.
- 9 Turn on the deflection plates.
- 10 Quickly click **Test Sort** twice to deposit a drop on the Eppendorf tube lids.
- 11 Verify that the drops are deposited on the center of each Eppendorf tube lid.

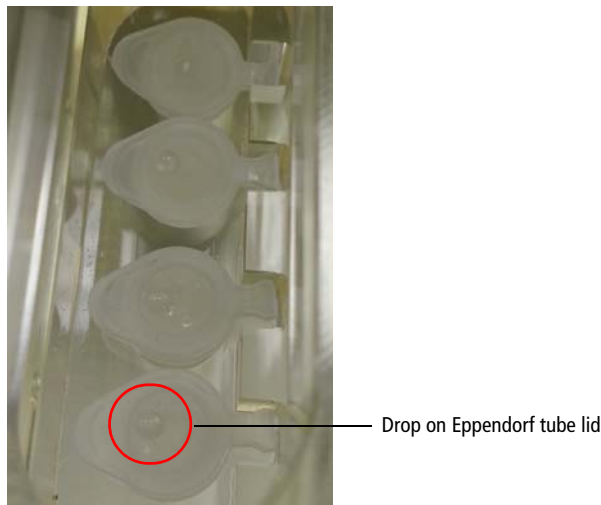

Tip For future reference, record the slider values or take a screen shot of the stream setup window.

Determining the Drop Delay – Manual Method

BD FACS Accudrop technology is used to determine the optimal drop-delay setting for your sorting application. For more information, see Drop-Delay Overview on page 71.

There are two methods for determining the drop delay.

- **Manual drop delay.** Using the standard method as described in the following sections.
- **Auto drop delay.** Using an automated algorithm method. See Determining the Drop Delay – Automatic Method on page 181.

NOTE Before beginning these procedures, make sure the stream is stable and the Sweet Spot is on.

Setting Up the Experiment

This section describes how to set the drop delay using the Accudrop experiment template. Because no data is recorded, the experiment can be reused as often as you like.

- 1 Create an experiment from the Accudrop Drop Delay template.

Select **Experiment > New Experiment**. Select the **Accudrop Drop Delay** experiment and click **OK**. See Figure 5-3 on page 177.

Figure 5-3 Experiment Templates window

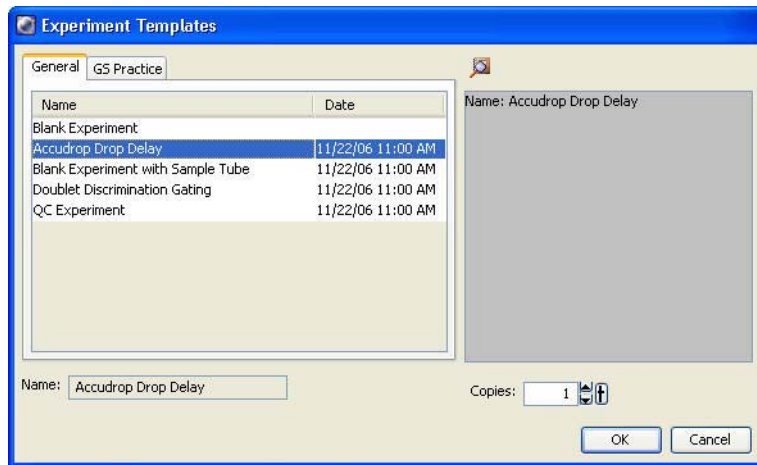

- 2 Expand **Specimen_001** and **Tube_001**.
- 3 Set the current tube pointer to **Tube_001**.
- 4 Open the sort layout by double-clicking it.

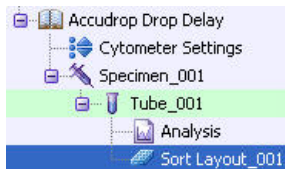

Using Manual Drop Delay

This section describes the manual method of optimizing the drop delay.

- 1 Load a tube filled with a suspension of Accudrop beads (approximately one to two drops of beads in 0.5 mL of PBS).



Movement of mechanical parts within the instrument can pinch or injure your hands or fingers. Keep your hands and clothing away from the loading port when a tube is loading or unloading. Do not place objects underneath the loading port.

- 2 In the **Laser** tab of the **Cytometer** window, set the window extension to zero.

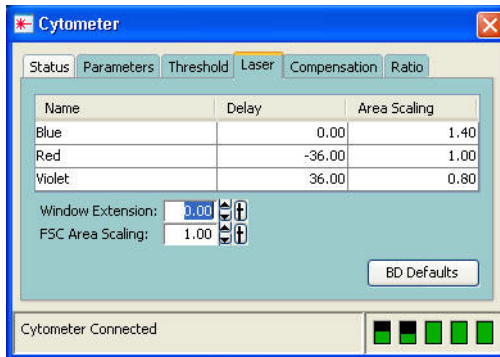

- 3 Adjust the flow rate to achieve an event rate of 1,000–3,000 events per second.
- 4 Turn on the voltage in the **Side Stream** window. Click **Sort** in the **Sort Layout** window.
- 5 Click **Cancel** at the **Confirm** dialog (Figure 5-4 on page 179).

Figure 5-4 Confirm dialog

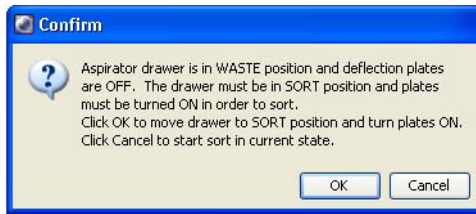

There is no need to collect the beads. When the drawer is closed, the beads are sorted to waste.

- 6 Adjust the micrometer dial (see Figure 1-22 on page 42) to obtain the brightest bead spot on the center stream.
- 7 Click the **Optical Filter** button in the **Side Stream** window.

This control moves the emission filter that allows you to view the Accudrop beads in front of the lower camera. When the control is clicked, the image switches from a raw image to a processed (digitized) image. The two boxes indicate the region of the image where the left and center stream intensities are calculated during image processing. The numbers shown are percentages of the total intensity.

If the left side stream is not completely contained in the left region, adjust the voltage slider to place the stream in the center of the region.

- 8 Verify that the sort precision mode is set to **Initial**.

See Sort Precision Modes on page 77 for more information.

- 9 Optimize the drop delay.

Adjust the drop-delay value in 1-drop increments (Ctrl+click arrow control) to achieve close to 100% intensity in the left side stream. Wait a few seconds after each click for a complete response to the delay change. See Figure 5-5 on page 180.

Figure 5-5 Sorting Accudrop beads in Initial mode

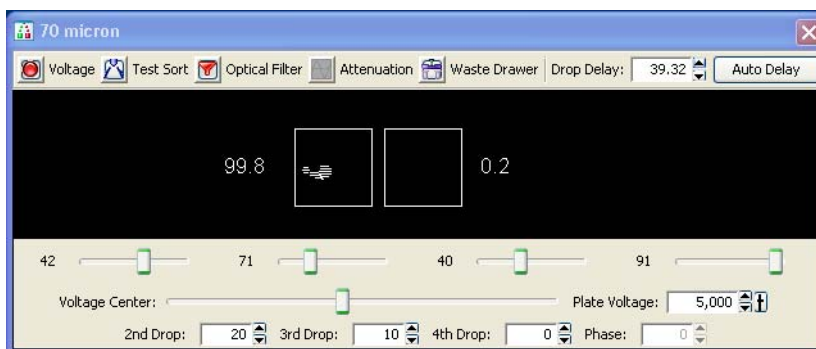

10 In the **Sort Layout** window, change the precision mode to **Fine Tune**.

11 Optimize the drop delay.

Adjust the drop-delay value in 0.03-drop increments (click the arrow control) until the left side stream intensity is greater than or equal to 90%. Wait a few seconds after each click for a complete response to the delay change.

Figure 5-6 Sorting Accudrop beads in Fine-Tune mode

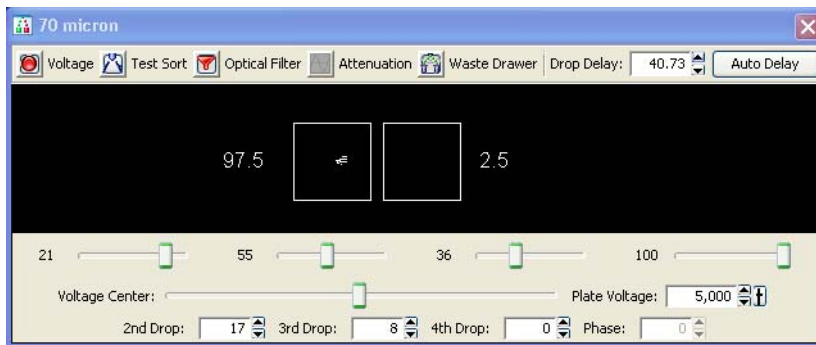

12 Click the **Optical Filter** button to move the emission filter away from the camera.

13 Reset the window extension to its original setting (typically 2).

- 14 Turn off the deflection plates.

Determining the Drop Delay – Automatic Method

The auto drop delay feature automates setting the drop delay to get optimized results from sorting. You should use this method after you have a good understanding of how drop delay works in general. See Using Manual Drop Delay on page 178 for more information.

Overview of Auto Drop Delay

Auto drop delay works best when the sort system is stable, and assumes that Accudrop beads are used. When the process is started, the auto drop algorithm uses several passes to find best drop delay possible under the current conditions of the system. Coarse passes are used to find the initial drop delay within 2 drops of the ideal. The coarse passes are faster than the fine-tune passes. Fine-tune passes are used to locate the ideal drop delay value considering the current conditions.

Using Auto Drop Delay

- 1 Set up an experiment for drop delay as described in Setting Up the Experiment on page 176.
- 2 Load a tube filled with a suspension of Accudrop beads (approximately 2 drops of beads in 0.5 mL of PBS).



Movement of mechanical parts within the instrument can pinch or injure your hands or fingers. Keep your hands and clothing away from the loading port when a tube is loading or unloading. Do not place objects underneath the loading port.

- 3 Adjust the flow rate to achieve these values of events per second:

70 micron = 1,000 to 3,000

85 micron = 800 to 2,000

100 micron = 600 to 1,500

130 micron = 400 to 1,200

Tip If this cannot be achieved using a flow rate setting between 1 and 5, adjust the bead concentration.

4 Turn on the voltage in the **Side Stream** window. Click **Sort** in the **Sort Layout** window.

5 Click **Cancel** in the **Confirm** dialog.

There is no need to collect the beads. When the drawer is closed, the beads are sorted to waste.

6 Adjust the micrometer dial (see Figure 1-22 on page 42) to obtain the brightest bead spot on the center stream.

7 Click the **Auto Delay** button in the **Side Stream** window.

A dialog similar to Figure 5-7 on page 183 opens. The graph in the left pane of the dialog represents brightness of the stream (Y axis) versus drop delay (X axis). Typically the graph should have a flat portion, with several small peaks in either direction (up or down) or one prominent peak.

NOTE If the original drop delay value was close to the appropriate value prior to starting auto delay, then you may not get a graph displayed because few data points were required to determine the optimal drop delay.

8 Select **Start Run** in the **Auto Drop Delay** dialog.

9 Monitor the **Auto Drop Delay** dialog for progress.

A message is displayed when the process is completed.

NOTE If the sort is stopped during algorithm execution (either by user action or because the system detected a failure), the run will be stopped with an appropriate message. Start the sort again, verify that the stream is stable and the sort is not pausing, and re-run the auto drop delay.

Figure 5-7 Auto drop delay dialog

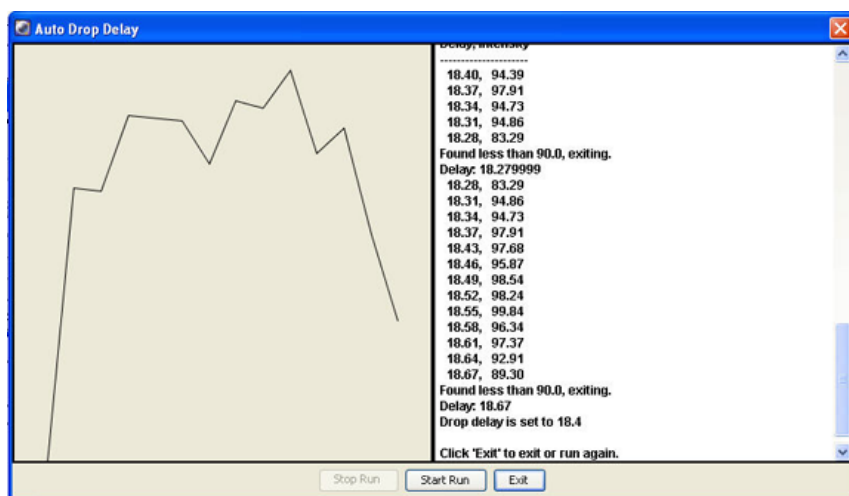

Sorting

Before beginning the sort, do the following:

- 1 Perform the steps outlined in Setting Up for Sorting on page 170.
- 2 Use gating tools and subsetting methods to define the population(s) of interest.

Examples of gating analysis can be found in Analyzing Data on page 160.

NOTE Gates drawn on a biexponential scale can be used for sorting. However, the cytometer will sort on a log scale. Therefore, a gate that crosses the zero boundaries will sort all events below zero into that gated population. This can cause a variance between the sort results and the statistical results in the software. If the gate is completely below zero on a biexponential plot, no events will be sorted.

NOTE Snap-to gates cannot be used for sort gates.

Setting Up the Experiment

☑ **Tip** When more than one drop is deflected in the same direction, residual charge from the first drop degrades the quality of the side streams. Thus, when four-way sorting or sorting into small wells where precise deflection is required, use the 4-Way Purity mode or select a mode with a yield mask of zero. For more information, see Yield Mask on page 74.

- 1 Create a new sort layout by clicking the **New Sort Layout** button on the **Browser** toolbar.

By default, the 2-Tube Sort Layout is displayed.

- 2 Make appropriate entries in the **Sort Layout** window.

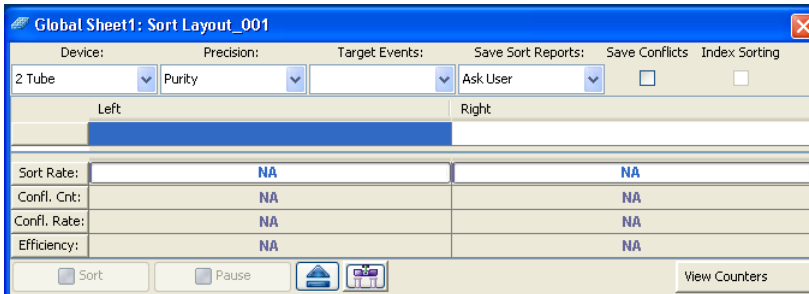

The screenshot shows the 'Global Sheet1: Sort Layout_001' window. At the top, there are several dropdown menus and checkboxes: 'Device:' set to '2 Tube', 'Precision:' set to 'Purity', 'Target Events:' (empty), 'Save Sort Reports:' set to 'Ask User', 'Save Conflicts' (unchecked), and 'Index Sorting' (unchecked). Below these are two columns labeled 'Left' and 'Right'. A table below shows performance metrics for both sides, all with 'NA' values. At the bottom, there are 'Sort' and 'Pause' buttons, a 'View Counters' button, and a small icon.

	Left	Right
Sort Rate:	NA	NA
Confl. Cnt:	NA	NA
Confl. Rate:	NA	NA
Efficiency:	NA	NA

- Select the collection device from the **Device** menu.
- Change the sort precision mode to **Purity** (two tubes), **4-Way Purity** (four tubes), or **Single Cell** (plate or slide).
- Enter the number of target events by selecting a value from the menu or entering a number in the field.
- Select a **Save Sort Reports** option: **Save None**, **Save All**, or **Ask User**. See Setting Up a Sort Layout on page 107.
- Select the **Save Conflicts** checkbox if you are using a 2- or 4-tube sort layout and want to save conflicts.

- Select the **Index Sorting** checkbox if you are doing an index sort. See Index Sorting on page 199.
- Select the sort location field(s) to be sorted into. Select multiple fields by dragging the mouse. Select a row or column by clicking the row or column header.
- Add the required population(s) to each sort location field.
- To display fewer counters in the **Sort Layout** window, click the **View Counters** button and clear a menu option. The corresponding counter is hidden. (Only counters with a checkmark next to the name are displayed.)

Starting and Monitoring the Sort

To start the sort:

- 1 Open the sort collection chamber door and install the collection tubes, plate, or slide.



The flow cell access door is equipped with a shutter mechanism that shuts off the laser light when the door is opened. To ensure there is no interruption to data acquisition, do not open the door while sorting or recording.

- 2 Close the sort collection chamber door.



Failure to close the sort collection chamber door prevents the evacuator from generating negative pressure in the chamber and could affect drop placement while sorting.

- 3 Install the sample tube onto the loading port and click **Load**.



Movement of mechanical parts within the instrument can pinch or injure your hands or fingers. Keep your hands and clothing away from the loading port when a tube is loading or unloading. Do not place objects underneath the loading port.

- 4 Adjust the flow rate.

Sorting results are typically optimized at lower flow rates.

- 5 (Optional) Turn on the deflection plates and open the aspirator drawer.

The deflection plates turn off automatically each time a tube is unloaded. If you do not turn them back on before beginning a sort, a dialog is displayed in which you can turn on the plates and open the aspirator drawer by clicking OK.

- 6 Verify that the current tube pointer is indicating the appropriate tube in the **Browser**, then click **Sort**.

- 7 Click **OK** if you are prompted to open the aspirator drawer or turn on the deflection plates.



If you click **Cancel**, sorting will begin with the deflection plates off and the drawer closed. As a result, sort populations will be identified and counted, but no deflection (or sorting) will occur. If you sort with the drawer closed, events will be sorted to waste.

- Tip** Click **Record Data** to save data for the tube. Acquisition and sorting continue after the required number of events has been recorded.

Sorting continues until the required number of cells has been sorted. Acquisition stops and the drawer closes when sorting is complete. If the number of Target Events is set to Continuous, sorting continues until you manually stop sorting by clicking the Stop Acquiring button in the Dashboard, or the Sort button in the Sort Layout window.

Monitor the sort progress in the Sort Layout window. The number of events sorted into each sort location is displayed in the corresponding field. The sort rate and sort conflict rate are displayed in the corresponding counter fields.

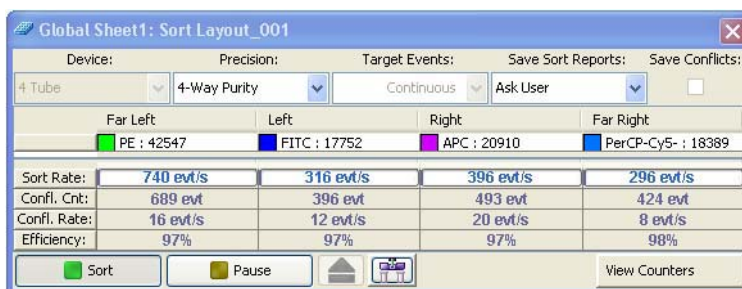

NOTE When the Sweet Spot is on, sorting pauses automatically if the Drop 1 or Gap values are out of range. This ensures that sorting occurs only under the proper breakoff conditions. If a more severe problem such as a clog is detected, the stream shuts off and sorting stops. The deflection plates shut off, the aspirator drawer closes, and the sample tube is unloaded. To clear a clogged nozzle, see Responding to a Nozzle Clog During a Sort on page 190.

- (Optional) You can print the sort report at this time, or open the report later and print it then. You can also export the report.

Stopping and Resuming a Sort

The Stop/Resume function allows you to temporarily stop the sort and still retain the counter values. This is particularly useful when the sample volume is low and you need to refill the tube, or to replace collection tubes.

Replacing a Sample Tube

1 To stop a sort while it is running, click the **Sort** button in the **Sort Layout** window.

2 If prompted, click **OK** to save the sort report.

You can set the sort report to save automatically after each sort. See Setting Up a Sort Layout on page 107.

3 Unload the sample tube by clicking **Unload** on the **Acquisition Dashboard**.

4 Refill the sample tube, then click **Load** in the **Acquisition Dashboard**.



Movement of mechanical parts within the instrument can pinch or injure your hands or fingers. Keep your hands and clothing away from the loading port when a tube is loading or unloading. Do not place objects underneath the loading port.

5 Click the **Resume** button in the **Sort Layout** window to continue sorting.

6 Click **OK** when you are prompted to open the aspirator drawer or turn on the deflection plates.

The sort counters resume from the value where they stopped. The threshold counter restarts. However, the value is accumulated and the total count is saved in the final sort report.

Replacing the Collection Tubes

1 To stop a sort while it is running, click the **Sort** button in the **Sort Layout** window.

2 If prompted, click **OK** to save the sort report.

You can set the sort report to save automatically after each sort. See Setting Up a Sort Layout on page 107.

- 3 Click **Stop Acquiring** in the **Acquisition Dashboard** to stop the sample flow.
- 4 Turn off the deflection plates by clicking the **Voltage** button in the **Side Stream** window.
- 5 Remove the lower section of collection tube holder by lifting up on the handle and pulling the lower section of the holder down and forward.
- 6 Replace the collection tubes as needed.
- 7 Reinstall the tube holder and pull down on the handle to secure it in place.
- 8 Click **Acquire Data** in the **Acquisition Dashboard** to restart the sample flow.
- 9 Click the **Resume** button in the **Sort Layout** window to continue sorting.
- 10 Click **OK** when you are prompted to open the aspirator drawer or turn on the deflection plates.

The sort counters resume from the value where they stopped. The threshold counter restarts. However, the value is accumulated and the total count is saved in the final sort report.

Pausing and Resuming a Sort

The Pause/Resume function allows you to temporarily pause the sort, and still retain the sort counter values. This is useful when you need to make adjustments to an experiment during a sort. Be aware that the sample continues to flow during a pause.

NOTE If you need to replace the sample tube to refill it, or to replace collection tubes, you should stop the sort. See *Stopping and Resuming a Sort* on page 187.

- 1 To pause a sort while it is running, click the **Pause** button in the **Sort Layout** window.
- 2 Make adjustments to the experiment as needed.

- 3 Click the **Resume** button in the **Sort Layout** window to continue sorting.

Responding to a Nozzle Clog During a Sort

Follow this procedure if your system does not have a BSC or the Aerosol Management Option (AMO).

If your system:

- Does not have a BSC, but does have the AMO, see *Responding to a Nozzle Clog During a Sort with the AMO* on page 310.
- Does have a BSC and the Aerosol Management System (AMS), see *Responding to a Nozzle Clog During a Sort* on page 336.

If the stream is disturbed during the sort (due in part to a clogged nozzle), the sort is designed to stop automatically and block the sort tubes (if Sweet Spot is on). The sort will not restart until the operator has cleared the clog. In the event of a nozzle clog, do not open the sort collection chamber door or access the sort tubes before following this procedure.



Cell sorters that use droplet generation methods, such as the BD FACSAria Fusion, can produce aerosols around the sample stream. When acquiring biohazardous samples, follow universal precautions at all times. Keep the sort block door and the sort collection chamber door closed during sorting. Follow these steps to stop sample flow and evacuate potential aerosols before opening the sort collection chamber door.

To clear a clogged nozzle:

- 1 If the stream has not already shut down automatically, turn off the stream by clicking the **Stream** button (with a checkmark) at the top of the **Breakoff** window.

This will shut off the stream, unload the sample, and close the aspirator drawer.

- 2 Turn on the stream and view the breakoff.

If the clog is removed, the breakoff will be similar to the breakoff before the clog.

- 3 If the clog is not cleared, turn the stream on and off several times to see if the clog will clear itself.
- 4 If the clog is not removed, turn the stream off and perform the Clean Flow Cell procedure with DI water (see *Cleaning the Flow Cell (Daily)* on page 206), followed by turning the stream on to see if the clog will be cleared.
- 5 With the aspirator drawer closed, wait for at least 3 minutes to clear aerosols before opening the sort collection chamber and the sort block door.
- 6 If it is necessary to change nozzles or remove a clog from a nozzle, see *Cleaning the Integrated Nozzle* on page 233.
- 7 With the stream turned off, open the sort block door and dry the plates and surfaces as needed.





When removing collection tubes, be aware that the outside of the tube is potentially contaminated. Use alcohol swabs or bleach to wipe the outsides of tubes.

- 8 Make sure that all chamber doors are closed and restart the stream.
- 9 Perform these tasks if needed:
 - Turn on the Sweet Spot
 - Check the drop delay
 - Check the side stream deflection

Setting Up for Sorting onto a Plate or Slide

The following sections describe how to set up for sorting onto a plate or slide. For general guidelines, see Setting Up for Sorting on page 170.

Installing the Sorting Hardware

  Any cytometer surface that comes in contact with biological specimens can transmit potentially fatal disease. Use universal precautions when handling sorting hardware. Wear suitable protective clothing and gloves.

- 1** Install the splash shield below the aspirator drawer.
 - a** Close the sort block door and open the sort collection chamber door, if needed.

The sort block door must be closed in order to open the collection chamber door.
 - b** Remove the tube holder, if one is installed.
 - c** Slide the splash shield into the slotted fittings below the sort aspirator drawer and push it all the way in.

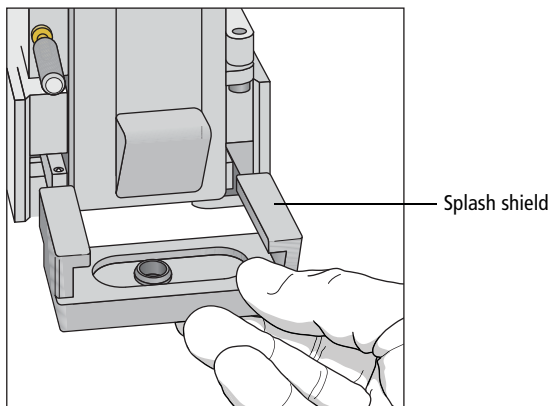

- 2 Click the **Access Stage** button to bring the ACDU stage to the front.
 - a Open an experiment, if one is not already open, and create a sort layout for any of the tubes.
 - b In the **Sort Layout** window, click the **Access Stage** button to move the stage to the front of the sort collection chamber.
- 3 Install the appropriate collection device on the stage (Figure 5-8).
 - If you are sorting into a plate, install the plate with well A1 toward the front of the stage.
 - If you are sorting onto a slide, install the slide-adaptor tray with the printed side up. If your slide has a frosted end, place the frosted end to the right.

Figure 5-8 ACDU stage set up with plate (left) and slide (right)

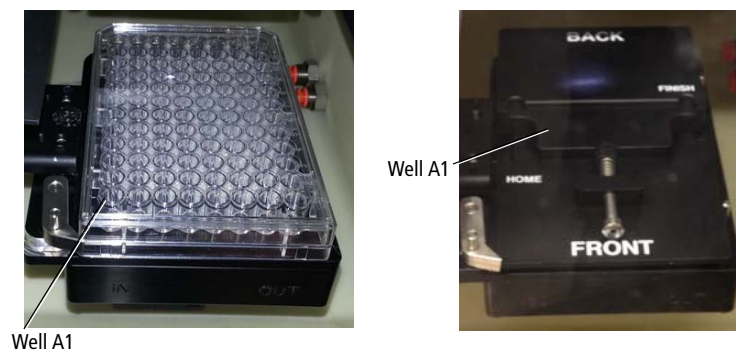

Sorting starts on the front left corner of the device (A1 location), and proceeds from front to back, and then from left to right, sorting in a serpentine motion. Thus, for a plate, sorting proceeds from well A1–A12, B12–B1, C1–C12, and so on.

When sorting onto a slide, sorting proceeds in rows across the short end of the slide, and in columns along the long end of the slide. Make sure that you set up your sort layout accordingly. See Figure 5-9 on page 194.

Figure 5-9 Sort order on a slide

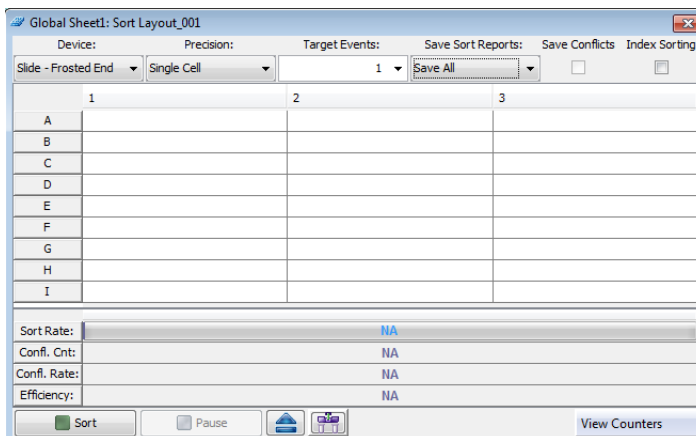
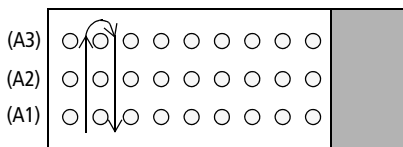

Setting Up the Stream

This section describes how to optimize side stream deflection and how to adjust the home location.

When sorting onto a plate or slide, the stage is pre-programmed to move a set distance between wells on a plate or spots on a slide. The home location is used as the starting point. The far left stream should hit the center of the well in the top left corner of a plate or the top left corner of a slide at the home location.

Default home location coordinates exist for each standard sort collection device: Falcon® multiwell plates with 6, 24, 48, 96, and 384 wells, and standard or frosted-end slides. For other plate types, you will need to create a custom device. See [Creating a Custom Device](#) on page 197.

Use the following procedure to verify the home location and adjust it.

- 1 Turn on the deflection plates.

Click the **Voltage** button in the **Side Stream** window. The voltage warning light illuminates, indicating that the plates are charged.

NOTE Make sure the center stream image does not move after the plates are turned on. Major movement of the center stream could indicate that the plates or the area around the plates needs cleaning. See External Cleaning on page 210.

- 2 Select **Sort > Home Device**.
- 3 In the **Device Setup** dialog, select the collection device you are using and click **Go to Home** (Figure 5-10 on page 195).

Figure 5-10 Device Setup dialog

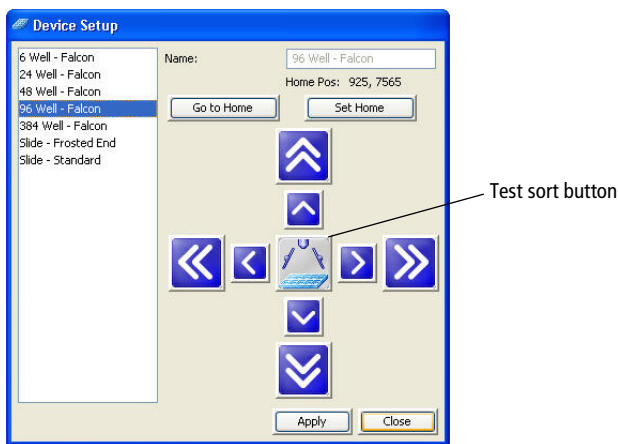

The stage moves to the pre-programmed home position.

- 4 Click the **Test Sort** button and optimize the far left side stream, then click the **Test Sort** button again to turn it off.

Ensure that the aspirator drawer is open. Adjust the far left slider for minimal deflection of the stream. The stream should be deflected just enough to clear the hole in the splash shield. Do not adjust the other sliders.

If you cannot see a stream image or the image is dim, adjust the micrometer dial on the diode laser (Figure 1-22 on page 42) to better view the streams.

- 5 Double-click the **Test Sort** button to deposit a drop at the home location.

NOTE To ensure consistent drop placement, keep the sort collection door closed when depositing drops on the vessel.

- 6 Inspect the collection device to see where the drop was deposited.

If you need to move the stage to the front, close the **Device Setup** dialog and click the **Access Stage** button in the **Sort Layout** window.

- 7 Wipe the collection device dry and place it back on the tray support.

If needed, click the **Access Stage** button to send the stage back and select **Sort > Home Position** to access the **Device Setup** dialog again.

- 8 Adjust the home location, if necessary.

Click the appropriate arrow buttons to move the tray support as needed. Large arrows move the tray by five steps. Small arrows move the tray by one step.

- 9 Repeat steps 5 through 8 until the drop is centered appropriately.

- 10 Click **Set Home**, then **Close**.

- 11 Click the **Voltage** button to turn off the deflection plates.

- 12 Optimize the drop delay.

See one of the following procedures:

- Determining the Drop Delay – Manual Method on page 176
- Determining the Drop Delay – Automatic Method on page 181

- 13 Proceed with **Sorting** on page 183.

Creating a Custom Device

You can program the ACDU stage to sort into any grid configuration. Create a custom device by entering the number of rows and columns and setting the home and farthest locations. BD FACSDiva software calculates the increment between rows and columns to determine the sort locations. The home and farthest locations for a 96-well plate are A1 and H12, respectively.

Figure 5-11 Home and farthest location on 9-drop slide (example)

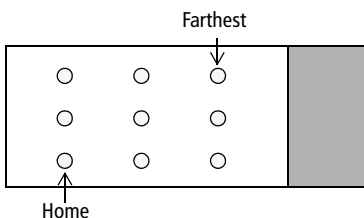

- 1 Select **Sort > Custom Devices**.
- 2 Click the **Add** button in the **Custom Devices** dialog.

A new device is added to the list of custom devices. By default, devices are named Custom Device_00x, where *x* is the next consecutively numbered device.

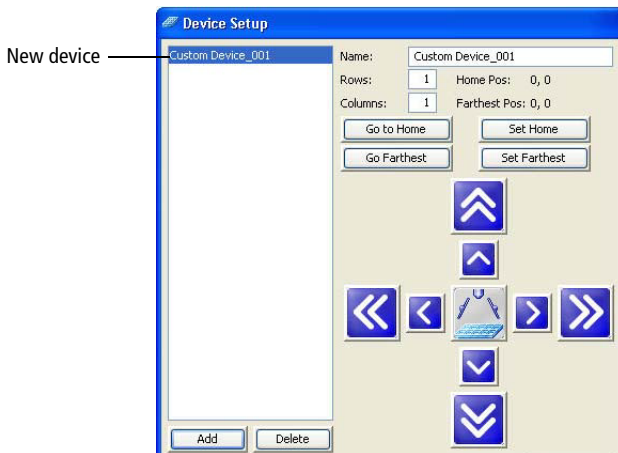

- 3** Select the text in the **Name** field and enter a new name.
- 4** Enter the number of sort location rows and columns.

A device can have up to 60 rows and 25 columns.
- 5** Use the arrow buttons and the **Test Sort** button to set the home location, then click **Set Home**.

See Setting Up the Stream on page 194 for details. There are no default values for custom devices, so greater initial adjustment with the arrow buttons is required.
- 6** Use the same procedure to set the farthest location, then click **Set Farthest**.

The farthest sort location is the well or spot on the lower-right corner of the collection device.
- 7** Click **Close**.

After you set the home and farthest locations, custom devices are listed in the Device menu in the Sort Layout window.

NOTE Once custom devices are defined, you cannot change the number of rows and columns.
- 8** Click the **Voltage** button to turn off the deflection plates.
- 9** Proceed with Determining the Drop Delay – Manual Method on page 176 and Sorting on page 183.

Deleting a Custom Device

- 1** Select **Sort > Custom Devices**.
- 2** Select the name of the custom device to be deleted in the **Custom Devices** dialog.
- 3** Click **Delete**.

The device is deleted from the Custom Device list, but is retained within any sort layouts where it was used.

Index Sorting

Index sorting allows you to sort single cells onto a plate or slide and indexes the well or slide location to the collected parameters for that cell. You can use this function to ensure that a sorted cell with a specific phenotype has been sorted. Index sorting is useful in characterizing subpopulations of phenotypically similar events using post-sort genetic, chemical, and/or metabolic applications.

Setting Up for Index Sorting

Index sorting uses the same steps as required in setting up for a plate or slide sort. Review the instructions in these sections:

- Setting Up for Sorting on page 170
- Setting Up for Sorting onto a Plate or Slide on page 192

To perform an index sort:

- 1 Create a new experiment, using a global worksheet, for the index sort.
NOTE If you want to export data from each well into one CSV file, you must use a global worksheet.
- 2 Create a new global worksheet.
- 3 Create the plots and gates needed to define the populations of interest.
- 4 Create a new sort layout or select an existing sort layout defined for index sorting.
- 5 Make the following selections in the **Sort Layout** window.
 - Precision = Single cell (recommended setting)

- Target events = 1
- Index sorting checkbox = Selected

Make the other selections in the **Sort Layout** window according to your experiment requirements.

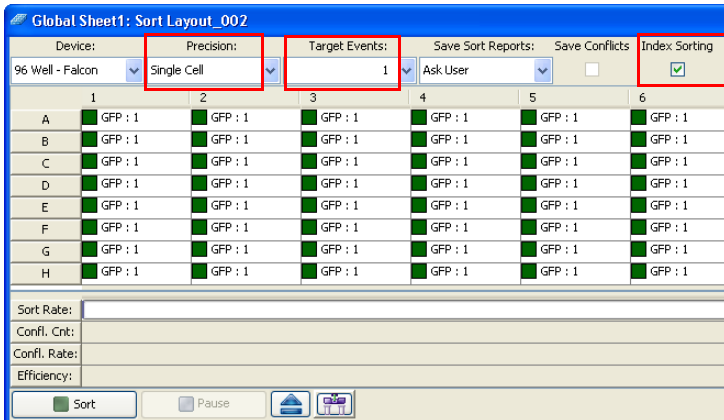

- 6 Click the **Sort** button in the **Sort Layout** window to start the sort.

You must be acquiring sample to start a sort. A new tube is automatically added to the experiment. Upon completion, the new tube will contain the index sort data.

- 7 When the sort is finished, right-click the new tube in the experiment and select **Index Sorting Analysis**.

The Index Sorting Analysis displays, as shown in Figure 5-12 on page 201.

Figure 5-12 Index Sorting Analysis window

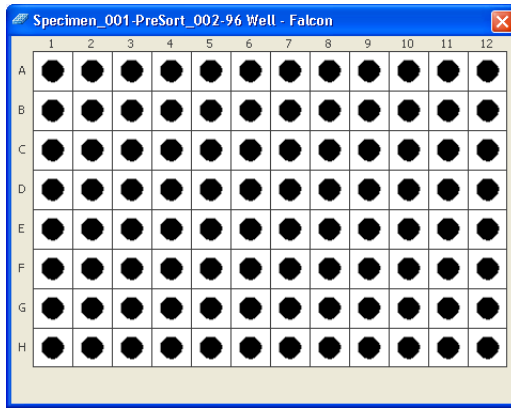

The color legend for the wells is shown in the following table.

Color	Indication
Black	Sorted well data is showing in the plots
Gray	Sorted well data is available, but not showing in the plots
White	No sorted events
Red	More than one event sorted into a well

- 8 Select a well in the Index Sort Analysis to see the event sorted into that well displayed in a plot.

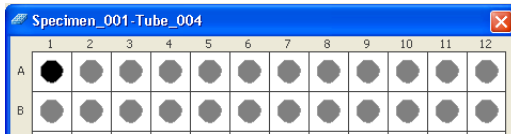

After selecting an individual well, the other wells in the Index Sort Analysis turn to gray, indicating that they contain data, but are not being displayed.

You can select multiple wells by Shift+clicking or Ctrl+clicking. You can also drag over multiple wells in the Index Sort Analysis to display multiple wells.

- 9** To increase the size of a dot on a plot for better visibility, open the population hierarchy, select a population, navigate to the **Population Inspector**, and select a larger size.
- 10** To see the statistics for an index sort, right-click a plot and select **Create Statistics View**.
- 11** To export the statistics for an index sort as a CSV file, right-click in the statistics view and select **Export Index Sort Statistics**.
- 12** In the dialog that opens, navigate to the location where you want to save the CSV file and click **Save**.

Terasaki Plate Adapter

A Terasaki plate adapter is available as an option to enable the use of 60-well and 72-well Terasaki plates with the ACDU. A Terasaki plate is installed into the adapter, and then the plate/adapter assembly is loaded onto the ACDU.

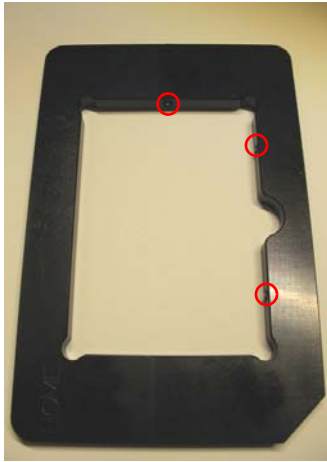

Terasaki plate adapter showing location of set screws

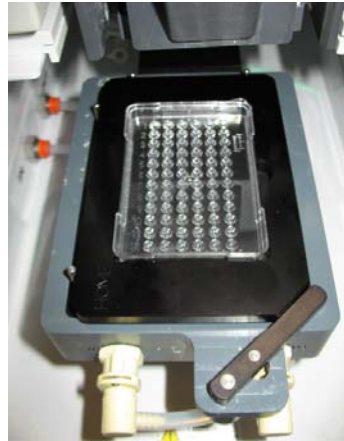

Terasaki plate in adapter installed on ACDU

Using the Adapter

The adapter has three set screws that enable the fit to be adjusted for the plates.

- 1 Install a Terasaki plate into the adapter with the A10 or A12 well at the bottom left corner of the adapter.
- 2 Tighten the set screws so the plate is held firmly and does not move within the adapter, but do not over-tighten because you need to be able to remove plates easily.

The set screws should not have to be adjusted after the initial fitting process.

Using the Correct Device in the Sort Layout

During the sort layout setup process, you have to select the correct device in the Sort Layout window so the ACDU knows the layout and location of the wells on the Terasaki plate.

- 1 In the **Sort Layout** window, select the **Device** menu.
- 2 Navigate to the bottom of the list, then select the plate you are using (60-well or 72-well).

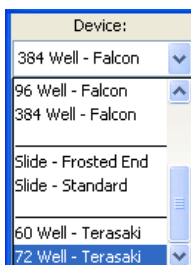

The sort layout displays with the correct number of rows and columns.

6

Shutdown and Maintenance

The BD FACSAria Fusion cytometer is designed to require minimum maintenance. However, to preserve the reliability of the cytometer, you must regularly perform basic preventive maintenance procedures. This chapter explains the routine maintenance procedures you should follow to keep your cytometer in good condition.

Shutdown and maintenance procedures are presented as follows:

- Daily Shutdown on page 206
- Scheduled Maintenance on page 211
- Unscheduled Maintenance on page 230

Daily Shutdown

In the BD FACSAria Fusion system, the recommended daily shutdown procedure is to run the Clean Flow Cell command with the closed-loop nozzle installed (see the next section). This procedure fills the flow cell with cleaning solution. This is normally sufficient to keep the flow cell clean and operating properly.

If the system is used to process many different sample types, or the system has problems with contamination, you can perform a more extensive cleaning by running the Fluidics Shutdown command. See Fluidics Shutdown (Weekly or As Needed) on page 207.

In addition to one of these procedures, you should also perform an external cleaning. See External Cleaning on page 210.

Cleaning the Flow Cell (Daily)

Use the Clean Flow Cell command to run a tube of DI water through the sample line and flow cell.

NOTE After the procedure is complete, the DI water remains in the flow cell until the stream is restarted.

To clean the flow cell:

- 1 Turn off the stream.
- 2 Remove the nozzle and install the integrated closed-loop nozzle. See Figure 6-1 on page 208.

If you are using a standard closed-loop nozzle, verify that there is an O-ring in the nozzle before installing it.

- 3 Select **Cytometer > Cleaning Modes > Clean Flow Cell**.
- 4 When prompted, install a tube containing approximately 3 mL of sterile, filtered DI water, then click **OK**.

The cytometer loads the tube and fills the flow cell with the DI water.

- 5 Click **OK** when the completion dialog opens.
- 6 Turn off the lasers using the laser buttons on the Laser Power Panel.
- 7 Turn off the cytometer main power.
- 8 Turn off the Temperature Control Option if it was used.
- 9 Exit BD FACSDiva software and shut down the computer.
- 10 Turn off the in-house air or the compressor.
- 11 Vent the air pressure from the sheath tank by pulling up on the vent ring.
- 12 Leave the BSC blower on and close the view screen by lowering the sash to the lowest (ready safe mode) position.

Fluidics Shutdown (Weekly or As Needed)

The Fluidics Shutdown command can be used to perform an extensive cleaning if the system is used to process many different sample types, or the system has problems with contamination. This procedure removes sheath fluid from the lines and fills them with 70% ethanol, and cleans the flow cell.

Preparing for Shutdown

- 1 Unload the sample tube, if one is loaded.
- 2 Turn off the stream.
- 3 Check the waste container and empty it if needed.

See Emptying the Waste Container on page 132.
- 4 Check the ethanol shutdown tank and refill it if needed.

See Refilling the Ethanol Shutdown Tank on page 129.

Running Fluidics Shutdown

- 1 Select **Cytometer > Fluidics Shutdown**.

The Fluidics Shutdown dialog opens.

- 2 Remove the nozzle from the flow cell assembly and click **Done**.
- 3 Insert the integrated closed-loop nozzle into the flow cell assembly and click **Done**. See Figure 6-1.

If you are using a standard closed-loop nozzle, verify that there is an O-ring in the nozzle before installing it.

Figure 6-1 Closed-loop nozzle installed in flow cell



- 4 Connect the air and fluid lines to the stainless steel ethanol shutdown tank. See Figure 6-2 on page 209.
 - a Disconnect the air line from the sheath tank and connect it to the air port on the ethanol shutdown tank.
 - b Disconnect the fluid line from the bottom side of the sheath filter and connect it to the ethanol filter on the ethanol shutdown tank. See Figure 6-2 on page 209.

Keep the sheath filter attached to the sheath tank. Do not run ethanol through the sheath filter.

c Click **Done**.

The system starts the cleaning process, and then displays a message at the bottom of the dialog.

Figure 6-2 Connecting air and fluid lines for shutdown procedure

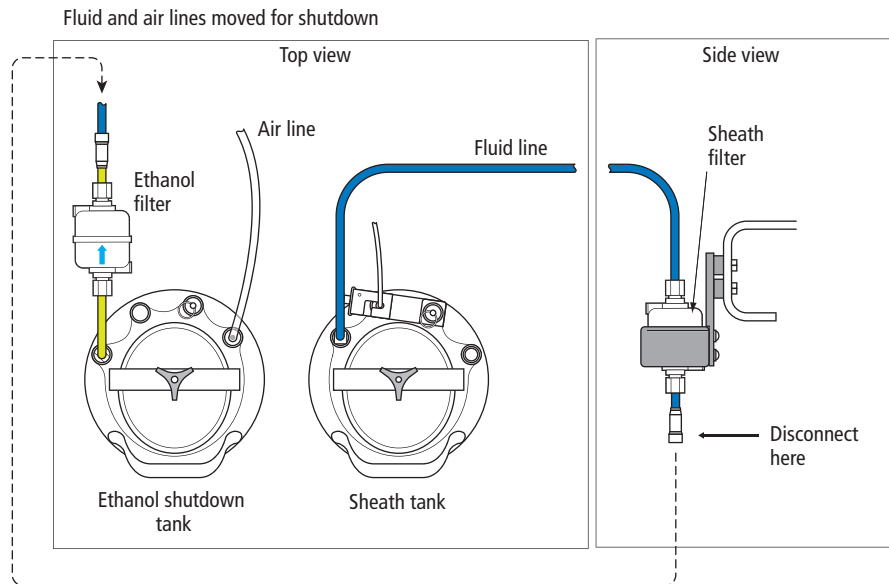

- 5 When prompted, install a tube containing 3 mL of sterile, filtered DI water on the loading port, then click **Done**.

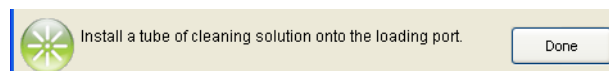

The cytometer loads the tube and continues the cleaning process. A progress message is displayed, and then Done is displayed when the process is complete.

- 6 Click **OK** when you see a message informing you that the system can be turned off.
- 7 Turn off the in-house air or the compressor.

- 8 Vent the air pressure from the sheath tank by pulling up on the ring on the pressure relief valve.
- 9 Turn off the lasers by pressing the lighted buttons on the Laser Power Panel.
- 10 Turn off the cytometer main power.
- 11 Turn off the Temperature Control Option if it was used.
- 12 Exit BD FACSDiva software and shut down the computer.
- 13 Leave the BSC blower on and close the view screen by lowering the sash to the lowest (ready safe mode) position.

External Cleaning

To keep the system free from salt buildup, wipe down all cytometer surfaces that have been exposed to sheath fluid. Clean surfaces with a cloth dampened with a 10% bleach solution, followed by DI water.



All cytometer surfaces that come in contact with biological specimens can transmit potentially fatal disease. Use universal precautions when cleaning cytometer surfaces. Wear suitable protective clothing, eyewear, and gloves.



To prevent shock, turn off the plate voltage before cleaning on or around the deflection plates. To prevent arcing (sparking), make sure the plates are completely dry before you turn the plate voltage back on.

The following surfaces should be inspected and cleaned when necessary:

- Inside the sort chamber
- Deflection plates
- Sample loading port
- Collection devices

Scheduled Maintenance

For optimal cytometer functioning, perform the following procedures according to the recommended maintenance schedule.

Table 6-1 Scheduled Maintenance

Procedure	Page number	Recommended Frequency
Internal Cleaning	page 212	See Table 6-2 on page 212
Purging the Fluid Filters	page 217	Weekly
Purging the Sheath Filter	page 218	Weekly
Changing the disposable waste cap (see Emptying the Waste Container)	page 218	Monthly
Changing the Fluid Filters	page 218	Every 6 months
Changing the Sheath Filter	page 219	Every 3 months
Changing the Ethanol Shutdown Filter	page 220	Every 6 months
Changing the Sample Lines	page 221	Every 4–6 months, or as needed
Changing the Air Filter	page 229	Every 6–12 months, depending on cytometer use and the quality of the air
Changing the Sheath Tank Air Filter	page 229	Every 6 months

Internal Cleaning

BD FACSDiva software includes four pre-programmed cleaning modes that can be used alone or in combination to provide the required level of cleaning. The following sections describe the different cleaning modes. See Table 6-2 for an overview of each mode.

Table 6-2 Cytometer cleaning modes

Cleaning Mode	Summary	Frequency
Sample Line Backflush on page 212	Flushes the sample line with sheath fluid.	After running samples with adherent cells or dye.
Cleaning the Flow Cell (Daily) on page 206	Cleans the sample path and the flow cell with DI water.	When indicated by distorted scatter or high CVs, or as a daily shutdown procedure.
Prime After Tank Refill on page 213	Primes the fluid lines for the designated fluid(s).	When a fluidics line is unplugged to refill a tank.
Prepare for Aseptic Sort on page 215	Decontaminates the complete sheath path and sample path with bleach, DI water, and ethanol.	When needed before aseptic sorting.

Sample Line Backflush

After a sample tube is unloaded, the sample line tubing within the sample injection chamber is automatically flushed inside and out with sheath fluid to eliminate potential sample carryover. Use the Sample Line Backflush command to perform additional backflushing of the inside of the sample line after a tube is unloaded. Perform the sample line backflush when you observe sample carryover or after running samples with adherent cells or dye.

NOTE Keep the stream running while performing the backflush.

- 1 Select **Cytometer > Cleaning Modes > Sample Line Backflush**.
- 2 Click **Start** to start the backflush.

- 3 Click **Stop** to stop the backflush, or click **Cancel** to stop the backflush and close the dialog.

The backflush does not stop automatically.

Prime After Tank Refill

Use the Prime After Tank Refill command to prime the fluid lines if a 5-L plastic fluidics container was disconnected for refilling.

- 1 Turn off the stream.
- 2 Select **Cytometer > Cleaning Modes > Prime After Tank Refill**.
- 3 Select the checkboxes for the tanks that were refilled, then click **OK**.

The cytometer proceeds with priming the specified tanks. A progress dialog opens while the tanks are being primed.

- 4 Click **OK** when the tank prime is complete.

Removing the Sheath Probe

The sheath probe must be removed from the sheath tank before autoclaving the tank in preparation for performing the aseptic sort procedure.

NOTE Do not autoclave the sheath probe. It is not designed to withstand the conditions of autoclaving.

Make sure to perform the following steps in sequence, so the containment device works properly.

- 1 Disconnect the air line from the sheath tank.
- 2 Vent the air pressure from the sheath tank by pulling up on the pressure relief valve. Verify that all of the pressure is released by pulling up a second time.
- 3 Loosen the nut at the top of the probe with a wrench (Figure 6-3).

Figure 6-3 Sheath probe containment device

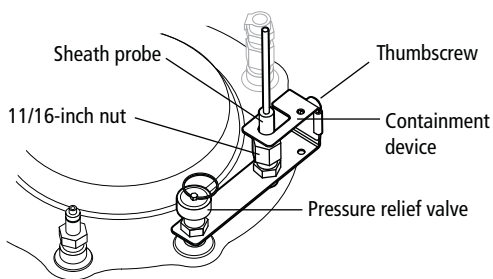

- 4 Loosen the thumbscrew on the containment device.
- 5 Pull the top section of the containment device straight up and out of the bottom section. See Figure 6-4.

Figure 6-4 Removing sheath probe

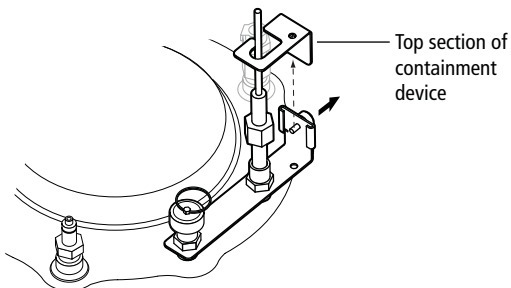

- 6 Finish loosening the 11/16-inch nut at the top of the probe and pull the probe straight up and out of the sheath tank.
- 7 Decontaminate the sheath probe using 70% ethanol. See Figure 6-5.

Figure 6-5 Sheath probe

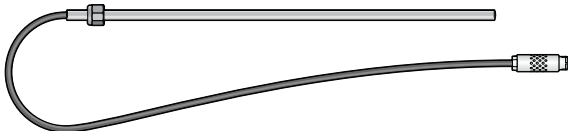

Prepare for Aseptic Sort

Use the Prepare for Aseptic Sort command when you want to decontaminate the entire sheath path. This procedure cleans the system with bleach, DI water, and ethanol.

Perform the following steps before starting the Prepare for Aseptic Sort command:

- 1** Verify that the pressure has been vented from the sheath tank and the sheath probe has been removed. See the preceding section.
- 2** Disconnect the fluid and air lines from the sheath tank.
- 3** Empty the sheath tank and rinse it with DI water.
- 4** Autoclave the sheath tank at 125°C and 15 psig for 30 minutes with a 7.5-minute warmup and shutdown cycle.
- 5** Fill the sterilized sheath tank with sterile sheath fluid.
- 6** Obtain a new sheath filter to replace the old filter when instructed to do so in the wizard. See Changing the Sheath Filter on page 219.
- 7** Install the decontaminated sheath probe into the sheath tank and tighten the nut securely with a wrench.
- 8** Install the top section of the containment device into the bottom section, and then tighten the thumbscrew.
- 9** Sterilize the DI water sensor by soaking in a 10% bleach solution for 10 minutes.
- 10** Fill the DI water container with sterile DI water and 3 mL of bleach per liter of DI water, and then reinstall the sterilized DI water sensor.

To run the Prepare for Aseptic Sort command:

- 1** Select **Cytometer > Cleaning Modes > Prepare for Aseptic Sort**.

Follow the instructions on screen as you perform the procedure.

- 2 Install the integrated closed-loop nozzle in the flow cell and click **Done**.

If you are using a standard closed-loop nozzle, verify that there is an O-ring in the nozzle before installing it.

- 3 Remove the fluid line from the DI water port, connect the fluid line from the bleach/BD FACSClean container to the DI water port, then click **Done**. See Figure 6-6.

Do not disconnect the sensors from either container.

Figure 6-6 Moving the bleach/BD FACSClean fluid line

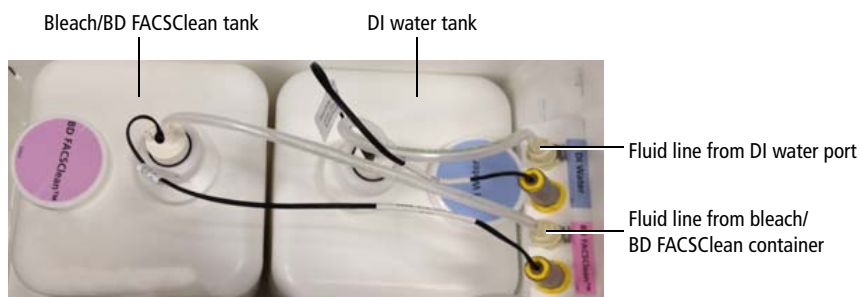

- 4 Disconnect the bleach/BD FACSClean fluid line from the DI water port, and connect it back to the bleach container port, then reconnect the DI fluid line to the DI water port, and click **Done**.
- 5 Disconnect the sheath fluid line from the sheath filter (at the output side) and connect it to the fluid out port on the connectors panel on the side of the fluidics drawer (see Figure 6-7). Click **Done**.

The system cleaning takes approximately 20 minutes.

Figure 6-7 Moving the sheath fluid line

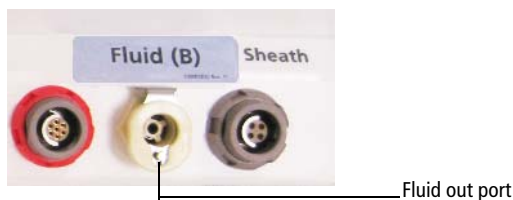

- 6 Disconnect the fluid line from the fluid out port on the side of the fluidics drawer and connect it to a new 0.2- μm sheath filter. See *Changing the Sheath Filter* on page 219.
- 7 Remove the old sheath filter and connect the new 0.2- μm sheath filter to the liquid port of the sterilized sheath tank.
- 8 Reconnect the fluid and air lines to the sheath tank.
- 9 To complete the process, select one of the two options.
 - To continue running samples, perform fluidics startup.
 - To turn off the system, perform the flow cell cleaning procedure.

Purging the Fluid Filters

Once a week, purge air from the fluid filters for the 5-L plastic containers by opening the bleeder valve on the top of each filter. This ensures that the filters will not dry out.

- 1 Open the bleeder valve a small amount and leave it open until fluid seeps out through the valve (see Figure 6-8 on page 218).
 - Tip** If the fluid does not seep, close the valve, prime the fluid lines, and try again. It might take a few minutes for the air to purge.
- 2 Close the valve.
- 3 Wipe up any excess fluid that might have dripped into the fluidics drawer.

Purging the Sheath Filter

Once a week, purge air from the sheath filter by opening the bleeder valve on the top of the filter. The sheath tank is pressurized, so do this task carefully to avoid spraying sheath fluid on any equipment.

- 1 Place a small container under the bleeder valve to catch any fluid.
- 2 Slowly open the bleeder valve a small amount and leave it open until fluid seeps out through the valve (see Figure 6-9 on page 219).
- 3 Close the valve.
- 4 Wipe up any excess fluid that might have dripped into the fluidics drawer.

Changing the Fluid Filters

We recommend changing the fluid filters every six months. Spare filters are included with the accessory kit.

Figure 6-8 Fluid filters



- 1 Remove the filter by pressing the tabs on each quick-disconnect coupling. (See Figure 6-8.)
- 2 Install the new filter with the flow arrow point down and connect the quick-disconnect couplings (Figure 6-8).

- 3 Write the current date on the new filter so you will know when to replace it.
- 4 Open the bleeder valve on top of the filter a small amount and leave it open until fluid seeps out through the valve.
- 5 Close the valve.
- 6 Wipe up any excess fluid that might have dripped into the fluidics drawer.

Changing the Sheath Filter

We recommend changing the sheath filter every three months, or when increased debris in an FSC vs SSC plot indicates that the sheath filter needs to be replaced. Spare filters are included with the accessory kit.

NOTE The sheath filter is the same as the one used for the ethanol shutdown filter. The filters can be used for either purpose.

- 1 Turn off the stream.
- 2 Remove the filter by pressing the tabs on each quick-disconnect coupling. (See Figure 6-9.)

Figure 6-9 Sheath filter

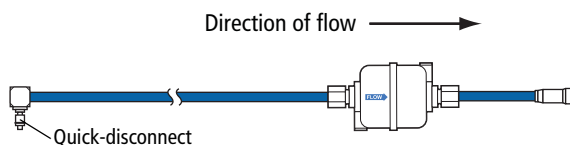

- 3 Unscrew the nuts at each end of the filter to remove the connecting tubing.
- 4 Locate a new filter and wrap the threads at each end with Teflon tape.
- 5 Observe the direction of flow on the filter and replace it in the same orientation.

- a Screw the nuts with connecting tubing onto each end of the filter and tighten finger-tight.
 - b Tighten each nut 1 to 2 additional turns with a wrench.
 - c Check for leaks once the pressure is turned on.
 - d Write the current date on the filter so you will know when to replace it.
- 6 Open the bleeder valve on top of the filter a small amount and leave it open until fluid seeps out through the valve.
 - 7 Close the valve.

Changing the Ethanol Shutdown Filter

We recommend changing the ethanol shutdown filter every six months. Spare filters are included with the accessory kit.

NOTE The ethanol shutdown filter is the same as the one used for the sheath filter. The filters can be used for either purpose.

- 1 Remove the filter by pressing the tabs on each quick-disconnect coupling. (See Figure 6-10.)

Figure 6-10 Ethanol filter

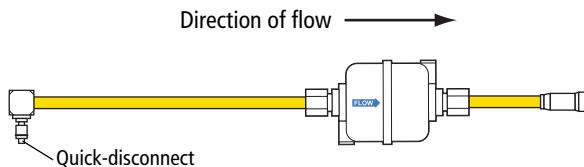

- 2 Unscrew the nuts at each end of the filter to remove the connecting tubing.
- 3 Locate a new filter and wrap the threads at each end with Teflon tape.
- 4 Observe the direction of flow on the filter and replace it in the same orientation.

- a Screw the nuts with connecting tubing onto each end of the filter and tighten finger-tight.
 - b Tighten each nut 1 to 2 additional turns with a wrench.
 - c Check for leaks once the pressure is turned on.
 - d Write the current date on the filter so you will know when to replace it.
- 5 Open the bleeder valve on top of the filter a small amount and leave it open until fluid seeps out through the valve.
 - 6 Close the valve.

Changing the Sample Lines

The primary sample line between the sample injection chamber and the pinch valve should be changed every 4–6 months or when decreased event rates indicate that the sample line might be clogged. The secondary sample line between the pinch valve and the cuvette flow cell needs changing only when it is kinked or clogged.

Figure 6-11 Primary and secondary sample lines

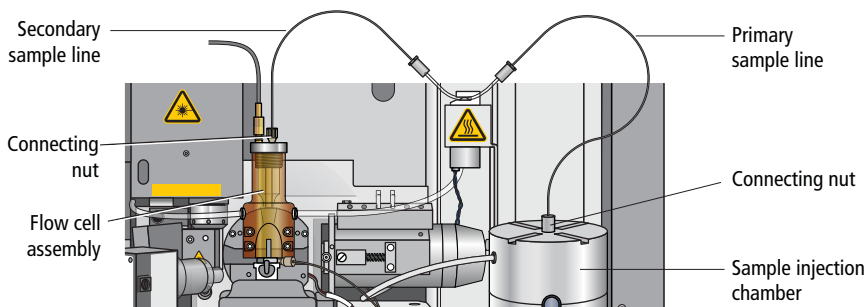

To withstand the high pressures generated by the BD FACSAria Fusion flow cytometer, the sample lines are attached using a two-piece compression fitting, in which a cone-shaped ferrule is compressed onto the tubing as the connecting nut is tightened.

To replace the tubing, you will need a 12-inch length of replacement tubing for the primary sample line, or a 7-inch length for the secondary line. Replacement tubing is supplied in the accessory kit. The ferrules and connecting nuts can be reused when the tubing is replaced.



All biological specimens and materials coming into contact with them can transmit potentially fatal disease. Handle used tubing and fittings as if capable of transmitting infection. Wear suitable protective clothing, eyewear, and gloves.

Changing the Primary Sample Line

To replace the primary sample line, you will need a 12-inch length of replacement tubing from the accessory kit. There is a different fitting at each end of the tubing, so the procedure is divided into two sections.

Assembling the Collet Fitting at the Pinch Valve

At the pinch valve end of the primary sample line, a collet fitting joins the sample line to the pinch valve tubing.

To replace the tubing:

- 1 Turn the stream off (if needed). Make sure the loading port is in the unload position.
- 2 Unscrew the nut from the collet fitting and pull the nut and collet apart.
- 3 Pull the pinch valve tubing out of the nut, and then pull the sample line out of the pinch valve tubing. See Figure 6-12.
- 4 Locate a new 12-inch piece of sample line tubing.
 - a Slide the collet over the pinch valve tubing, then slide the nut over the new sample line tubing.

Figure 6-12 Collet nut fitting on pinch valve tubing

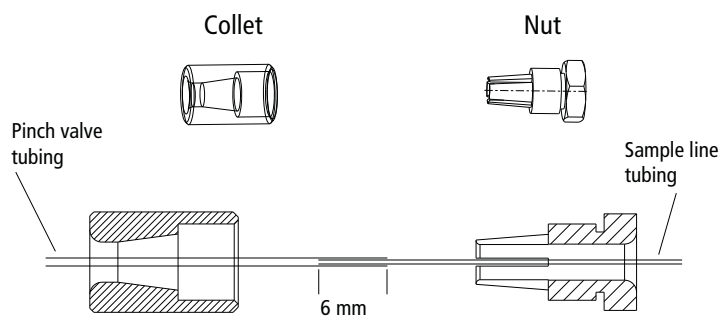

- b** Slide the pinch valve tubing over one end of the sample line tubing until approximately 6 mm of the sample line is inside the pinch valve tubing.
- c** Slide the pinch valve tubing on the inside of the teeth of the nut until it stops.



Ensure that the pinch valve tubing is inserted inside the teeth of the nut. Failure to do so can cause the bubble detector to malfunction.

- d** Couple both pieces of the fitting together and then tighten until finger-tight.

Primary Sample Line – Sample Injection End

At the sample injection end of the primary sample line, a compression fitting secures the sample line at the top of the sample injection chamber.

Figure 6-13 Primary sample line insertion

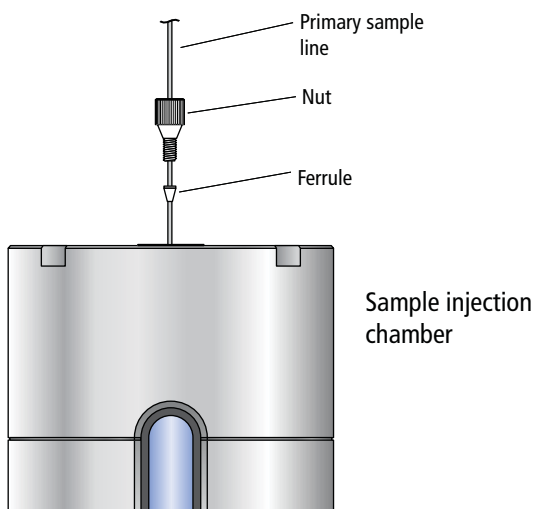

- 1 Turn the stream off (if needed). Make sure the loading port is in the unload position.
- 2 If there is a sample line filter installed, remove it by pulling it off the sample line.

To gain access to the filter, see *Installing or Removing a Sample Line Filter* on page 239.

- 3 Unscrew the connecting nut at the top of the sample injection chamber and slowly pull out the sample line. (See Figure 6-11 on page 221.)
- 4 Ensure that a cone-shaped ferrule is attached to the sample line.

Figure 6-13 shows an example of a ferrule. If the ferrule was left behind in the injection chamber fitting, gently push the tip of the ferrule-removal tool (included in a small vial inside the accessory kit) into the top of the ferrule and pull the ferrule straight out. See Figure 6-14.

After using the tool, you might need to replace the ferrule. If the ferrule is damaged, replace it with a spare (included in the accessory kit).

Figure 6-14 Ferrule tool



- 5 Slide the ferrule and nut off the end of the sample line.
- 6 Slide the nut and then the ferrule onto the end of the new sample tubing.

Leave approximately 5 inches (12.7 cm) of tubing extending out of the sample injection chamber end. (This length can be adjusted depending on the depth of your sample tube.) This length is referred to as the pilot, as shown in Figure 6-15.

Figure 6-15 Components of a compression fitting

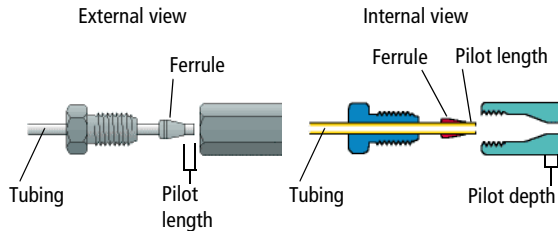

- 7 Insert the pilot tubing into its fitting, ensuring that the tubing reaches the intended pilot depth.



Do not to bend the primary sample line during insertion.

Insert the sample line into the sample injection chamber fitting. Push the tubing from the top until it is slightly above the bottom of the chamber viewing window. Finger-tighten the nut on top of the chamber so the sample line is secure.



Do not overtighten the nut and do not use tools. Over-tightening the nut can kink or damage the tubing.

- 8 Check the fitting connections at both ends to make sure they are not leaking.

Turn on the stream, load a tube of DI water, and make sure none of the fittings are leaking. If needed, unload the tube, turn off the stream, and tighten the fittings. After tightening, if leaking still occurs, replace the ferrule.



Make sure all fittings are securely tightened. If any fitting is loose, the tubing could detach during high-pressure operation, exposing the operator to potentially biohazardous sample spray.

- 9 Verify the length of the sample line.

The sample line should not bow or bend when a tube is loaded. If you need to adjust the length, unscrew the nut on top of the sample injection chamber, adjust the length, and tighten the nut again.

See *Installing or Removing a Sample Line Filter* on page 239 for detailed instructions on verifying sample line length. Disregard any steps that do not apply.

Changing the Secondary Sample Line

This section describes changing the secondary sample line (see Figure 6-11 on page 221). There is a different fitting at each end of the tubing, so the procedure is divided into two sections.

Pinch Valve End

The procedure to replace the secondary sample line at the pinch valve end is the same as for the primary sample line, except the replacement line is a 7-inch length. See *Assembling the Collet Fitting at the Pinch Valve* on page 222.

Flow Cell End

- 1 Turn the stream off.

- 2 Unscrew the connecting nut at the top of the flow cell and slowly pull out the sample line. (See Figure 6-16.)

Figure 6-16 Secondary sample line insertion

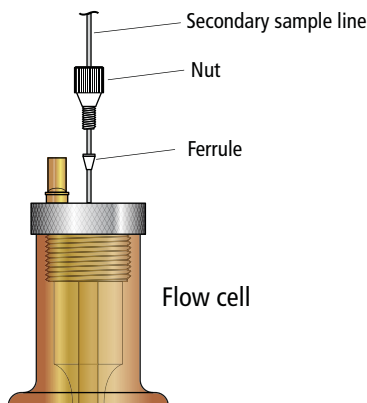

- 3 Ensure that a cone-shaped ferrule is attached to the sample line.

If the ferrule was left behind in the flow cell fitting, gently push the tip of the ferrule-removal tool (included in the accessory kit) into the top of the ferrule and pull the ferrule straight out.

After using the tool, you might need to replace the ferrule. If the ferrule is damaged, replace it with a spare (included in the accessory kit).

- 4 Slide the ferrule and nut off the end of the sample line.
- 5 Slide the nut and then the ferrule onto the end of the new sample tubing.

Leave approximately 0.1 inch (0.25 cm) of tubing extending out of the ferrule. This length is referred to as the pilot, as shown in Figure 6-15 on page 225.

- 6 Insert the pilot tubing into its fitting at the top of the flow cell, ensuring that the tubing reaches the intended pilot depth.



Within the cuvette flow cell fitting, make sure the pilot is seated flush against the pilot depth. Dead volume between the pilot and the pilot depth can lead to sample carryover or leaking.

- 7 Finger-tighten the nut at the top of the flow cell to secure the sample line.



Do not overtighten the nut and do not use tools. Over-tightening the nut can kink or damage the tubing.

- 8 Check the fitting connections at both ends to make sure they are not leaking.

Turn on the stream, load a tube of DI water, and make sure none of the fittings are leaking. If needed, unload the tube, turn off the stream, and tighten the fittings. After tightening, if leaking still occurs, replace the ferrule.



Make sure all fittings are securely tightened. If any fitting is loose, the tubing could detach during high-pressure operation, exposing the operator to potentially biohazardous sample spray.

Changing the Air Filter

The BD FACSAria Fusion cytometer has an air filter in the sort collection chamber door.

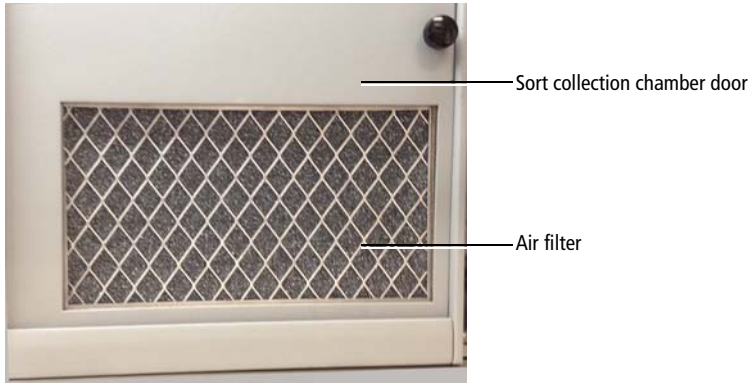

To change the filter in the sort collection chamber door, slide out the old filter and slide in the new filter. See Replacing the Air Filter on page 317 for more information.

Changing the Sheath Tank Air Filter

Check the inline air filter on the sheath tank air line periodically for any signs of debris or discoloration. Replace with a new air filter from the accessory kit every six months, or sooner if needed.

Figure 6-17 Inline air filter for sheath tank



- 1 Turn off the cytometer.
- 2 Pull the tubing off each end of the air filter.
- 3 Install a new filter with the directional arrow pointing toward the sheath tank.

Unscheduled Maintenance

There are several cytometer components that should be cleaned periodically or checked for wear and replaced if necessary. See the indicated sections for the following maintenance procedures.

Table 6-3 Unscheduled maintenance

Procedure	Page Number	Recommended Frequency
Changing the Integrated Nozzle	page 231	As needed for different sized particles
Cleaning the Integrated Nozzle	page 233	When stream irregularities indicate that the nozzle is clogged
Temporary Replacement of a Seal	page 236	As needed when seal is lost or damaged in an integrated nozzle
Closed-Loop Nozzle Maintenance	page 237	As needed

Table 6-3 Unscheduled maintenance

Procedure	Page Number	Recommended Frequency
Installing or Removing a Sample Line Filter	page 239	When the sample line filter needs to be installed or changed
Changing the Pinch Valve Tubing	page 241	As needed
Cleaning the Camera Windows	page 244	When smudges appear in the Breakoff or Side Stream windows
Removing the Deflection Plates	page 247	As needed to clean the deflection plates
Lubricating the Sample Injection Chamber O-Ring	page 248	As needed when the O-ring is dry
Using Custom Optical Filters	page 249	As needed
Cleaning the Optical Filters	page 250	As needed when changing a filter
Removing or Installing the FSC ND Filter	page 251	As needed

Changing the Integrated Nozzle

Three sizes of nozzles are provided with your cytometer: 70, 85, and 100 μm . A 130- μm nozzle can be ordered as an option. The size is marked on the nozzle. The closed-loop nozzle used for cleaning and shutdown procedures is also changed with this procedure.



Any cytometer surface that comes in contact with biological specimens can transmit potentially fatal disease. Use universal precautions when handling sorting hardware. Wear suitable protective clothing, eyewear, and gloves.

- 1 Turn off the stream and open the flow cell access door.
- 2 Turn the nozzle-locking lever counterclockwise to the 9:00 position, and pull the nozzle out of the cuvette flow cell (Figure 6-18).

Figure 6-18 Nozzle-locking lever

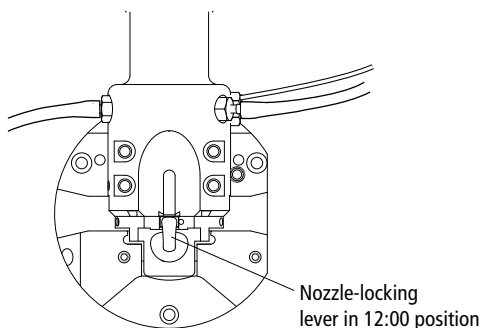

- 3** Insert the new nozzle into the flow cell (with the top side facing up) and push it gently all the way forward until it stops.
- 4** Turn the nozzle-locking lever clockwise to the 12:00 position.
- 5** Turn on the stream and make sure it flows smoothly from the nozzle into the center of the waste aspirator.

If the stream is flowing but the breakoff is too long or the gap is unsteady, this could indicate that there are bubbles in the flow cell. If these conditions occur, turn off the stream, wait for 10 seconds, and turn on the stream again.

If you see any dripping or spraying, or the stream image appears abnormal, turn off the stream and see *Troubleshooting the Stream* on page 254.

NOTE After changing the nozzle, you might need to adjust the angle of the sort block to re-center the stream in the aspirator. To do so, loosen the adjustment screws on both sides of the deflection plates and rotate the sort block (see Figure 1-11 on page 31). Tighten the screws when the stream is centered in the aspirator. For further assistance, see *Troubleshooting the Stream* on page 254.

Cleaning the Integrated Nozzle

Use the following procedure to clean the nozzle when the stream appears blocked or distorted. To verify that the nozzle is clogged, examine the opening at the center of the seal area under a microscope. Figure 6-19 shows an example of an unclogged nozzle tip.

Figure 6-19 Magnified view of an integrated nozzle tip

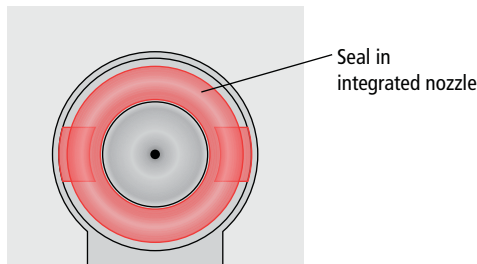

All biological specimens and materials coming into contact with them can transmit potentially fatal disease. Handle nozzles as if capable of transmitting infection. Wear suitable protective clothing, eyewear, and gloves.

To clean the integrated nozzle:

- 1 Remove the nozzle from the flow cell by turning the nozzle-locking lever counterclockwise to the 6:00 position, then pull the nozzle straight out.
- 2 Sonicate the nozzle for approximately 1 minute in a test tube containing DI water. Repeat the sonication until the nozzle is clean.



Do not use bleach, Contrad®, or any strong detergents to clean the nozzle. See Table 6-1 on page 211.

- 3 Allow the nozzle to air dry for a few minutes. Do not wipe the nozzle with anything, because it could leave fibers or other contamination.
- 4 Insert the nozzle into the flow cell with top side facing up and push it gently forward until it stops.

- 5 Turn the nozzle-locking lever clockwise to the 12:00 position.
- 6 Turn on the stream and make sure it flows through the nozzle properly.

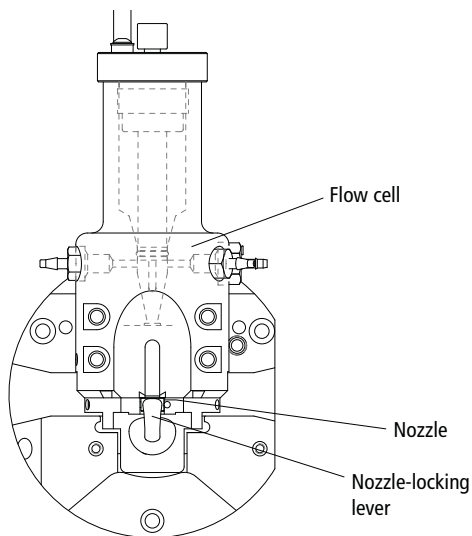

Note that after re-installing the nozzle, you might need to change the angle of the sort block to re-center the stream in the aspirator. To do so, loosen the adjustment screws on both sides of the deflection plates and rotate the sort block (see Figure 1-11 on page 31). Tighten the screws when the stream is centered in the aspirator. For further assistance, see *Troubleshooting the Stream* on page 254.

Handling the Integrated Nozzle

In addition to following proper cleaning instructions, follow these precautions when handling the integrated nozzles.

Precaution	Result
Always use the integrated closed-loop nozzle for cleaning and shutdown procedures.	Keeps the flow cell clean and reduces the chances for clogs. A clean flow cell provides improved sensitivity and higher performance.
Do not expose integrated nozzles for long periods of time to bleach or detergents. However, you can prepare for the aseptic sort procedure without causing any problems to the O-ring in the integrated nozzle.	Prevents the seal from coming loose and falling out.
Do not expose integrated nozzles to strong base solutions such as Contrad 70.	Prevents the seal from coming loose and falling out. Any contact with such solutions might damage the seal.
Do not wipe the surface of the seal with anything.	Prevents damage to the seal that could result in leaking.

Temporary Replacement of a Seal

The standard O-ring can be used as a short-term replacement in the integrated nozzle, if the original seal has been lost or damaged, but a new integrated nozzle will provide better long-term usability. See Accessory Kit on page 278 for part numbers for ordering integrated nozzles.

Standard O-rings (part number 333084) are supplied in the accessory kit. The following procedure describes how to install a standard O-ring in an integrated nozzle.

- 1** Make sure the groove in the nozzle is clean.

If the any part of the seal is still in the nozzle groove, sonicate the nozzle in a bleach solution until the seal comes out. Rinse the nozzle in DI water after sonicating.

- 2** Use the wooden end of a cotton swab, or similar tool, to install the O-ring in the nozzle groove, then allow the nozzle to air dry for a few minutes.

Do not wipe the nozzle with anything, because it could leave fibers or other contamination, or dislodge the O-ring.

- 3** Use the magnifier in the accessory kit, or a microscope, to inspect the nozzle to verify that the O-ring is installed all the way into in the groove.

Closed-Loop Nozzle Maintenance

The closed-loop nozzle and related tubing should be cleaned if there are any indications of clogging or kinked tubing.

Cleaning the Integrated Closed-Loop Nozzle

- 1 Turn off the stream and open the flow cell access door.
- 2 Remove the closed-loop nozzle from the cuvette flow cell.

Turn the nozzle-locking lever counterclockwise to the 6:00 position. Remove the nozzle by pulling it straight out. See Figure 6-20.

Figure 6-20 Closed-loop nozzle



- 3 Unscrew the nut on the side of the nozzle to remove the tubing.
Make sure that the ferrule stays on the tubing as you remove it.
- 4 Sonicate the nozzle for approximately 1 minute.
Sonicate the nozzle in a test tube containing DI water or a mild detergent. Repeat the sonication as needed until the nozzle is clean.
- 5 Make sure that the ferrule is on the tubing, then screw the nut back into the hole in the side of the closed-loop nozzle. See Figure 6-21.

Replacing the Tubing on the Closed-Loop Nozzle

To replace the tubing on the closed-loop nozzle, use this procedure. Use a 7-inch length of sample tubing from the accessory kit as the replacement.

Figure 6-21 Replacing tubing from closed-loop nozzle

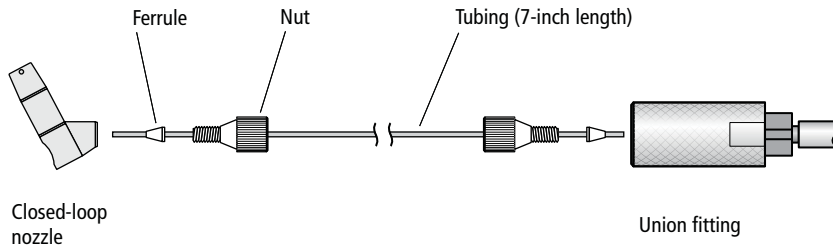

To replace the tubing:

- 1** Unscrew the nut from the closed-loop nozzle and from the union fitting and pull out the tubing from both places.

Make sure that the ferrule comes out on the tubing on both ends. If not, use the ferrule tool to remove it. See Figure 6-14 on page 225.

- 2** Slide the nut and ferrule off each end of the tubing.
- 3** Slide the nut and ferrule onto the new tubing as shown in Figure 6-21.

Insert the tubing into the closed-loop nozzle and slowly tighten the nut until secure. Do not over-tighten. Make sure that the tubing is pushed all the way in while tightening the nut.

- 4** Insert the tubing into the union fitting and slowly tighten the nut until secure. Do not over-tighten. Pull gently on the tubing to ensure that it is secure.

Installing or Removing a Sample Line Filter

Sample filters can be installed on the end of the sample line to filter out large particles from a sample. Pre-filtering the sample before beginning any sorting is recommended.

Two sizes of sample line filters are included in the accessories kit: 35 micron (green) and 50 micron (blue). The filters can be changed as often as required. The sample filters are not intended for use with the 1-mL microtubes.

NOTE When a sample filter is installed, the sample flow rate can be slowed down due to the effect of particles in the sample fluid clogging the filter.

- 1 With the stream turned on, select **Change Sample Filter** from the **Cytometer** menu.
- 2 A wizard opens with the instructions. See Figure 6-22.

Figure 6-22 Sample line filter wizard

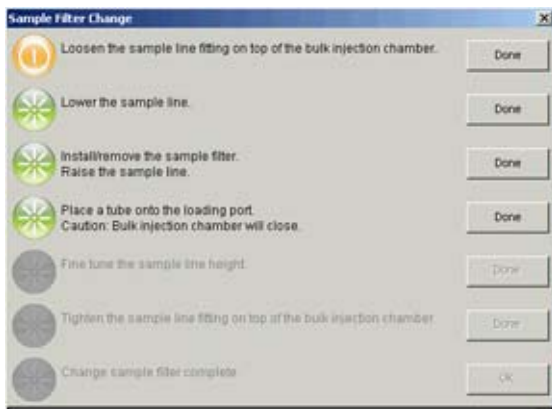

- 3 Loosen the sample line fitting nut at the top of the injection chamber to allow the sample line to slide freely through the fitting. See Figure 6-23.

Figure 6-23 Loosen nut to move sample line

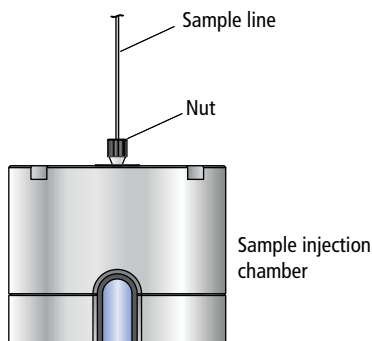

- 4 Push the sample line down so the end is below the bottom of the sample injection chamber.

Figure 6-24 Sample line filter installed

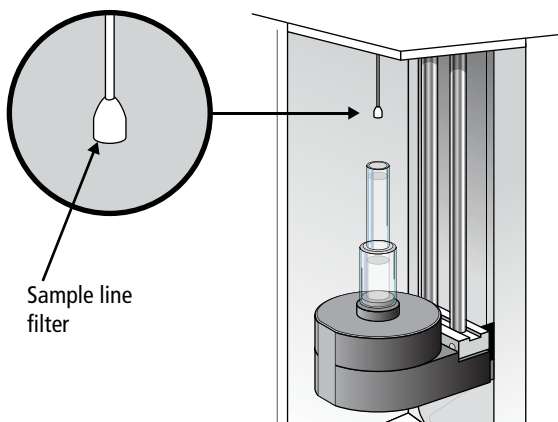



- 5 Install the sample line filter by sliding it onto the end of the line, then click **Done**. See Figure 6-24.



Do not bend the sample line while installing the filter.

- 6 Pull the sample line up to operation height, slightly above the chamber viewing window.

- 7 Place a tube onto the loading port.

  Movement of mechanical parts within the instrument can pinch or injure your hands or fingers. Keep your hands and clothing away from the loading port when a tube is loading or unloading. Do not place objects underneath the loading port.

- 8 Click **Done** to raise the sample injection chamber.

  Be careful of a pinching hazard as the sample injection chamber is raised.

The sample line should not bow or bend when a tube is loaded.

- 9 Adjust the sample line height if needed.
- 10 Tighten the sample line fitting and click **Done**.

The bulk injection chamber is lowered and the sample purge mode is turned on for about 5 seconds until several drips exit the filter. A message is displayed at the bottom of the wizard.

- 11 Click **Done** to complete the process.

Changing the Pinch Valve Tubing

The tubing that runs through the bubble detector and the pinch valve should be changed as needed. The system ships with replacement tubing cut into 3-inch lengths, found in the accessory kit.

Figure 6-25 Pinch valve tubing

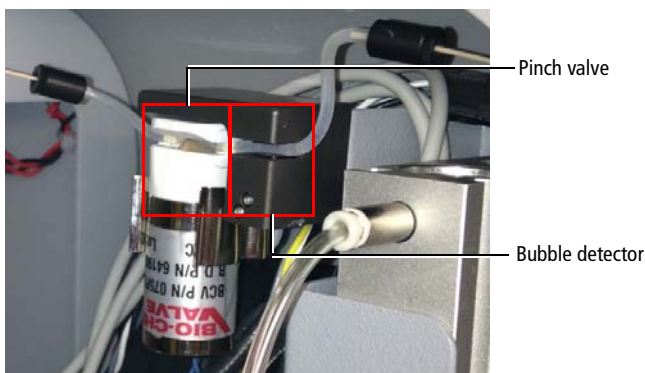

To replace the tubing:

- 1 Turn off the stream. Make sure the loading port is in the unload position.
- 2 Pull the existing pinch valve tubing out of the slot in the pinch valve and the bubble detector.

Grasp the tubing with two fingers next to the pinch valve and two fingers next to the bubble detector. Pull the tubing straight out from the slots. The tubing pops out with a small amount of pulling action. See Figure 6-26.

Figure 6-26 Removing tubing from bubble detector and pinch valve

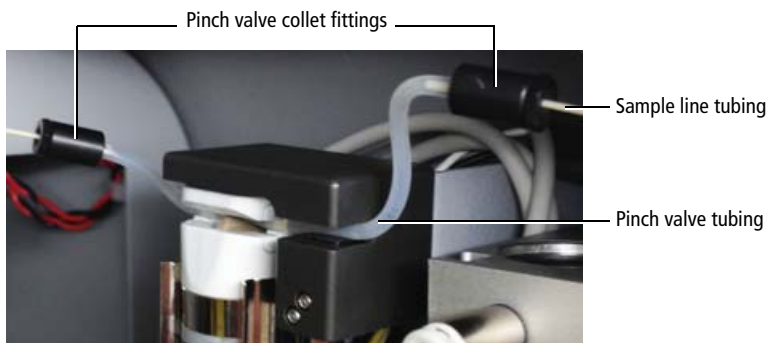

- 3 Unscrew the nut on the black collet fitting at each end of the tubing, and pull the pinch valve tubing out of both fittings.

Leave both pieces of the fitting on the sample line tubing.

- 4 Install a new 3-inch piece of pinch valve tubing. See Figure 6-27 on page 243.
 - a Slip the collet over one end of the new pinch valve tubing.
 - b Slide the pinch valve tubing over the sample line tubing until approximately 6 mm of the sample line is inside the pinch valve tubing.
 - c Slide the pinch valve tubing on the inside of the teeth of the nut until it stops.
 - d Couple both pieces of the fitting together and then tighten until finger-tight.
 - e Repeat steps a through d at the other end of the tubing.
 - f Check to see that both ends of the new pinch valve tubing are held securely in the compression fittings.

Figure 6-27 Collet nut fitting on pinch valve tubing

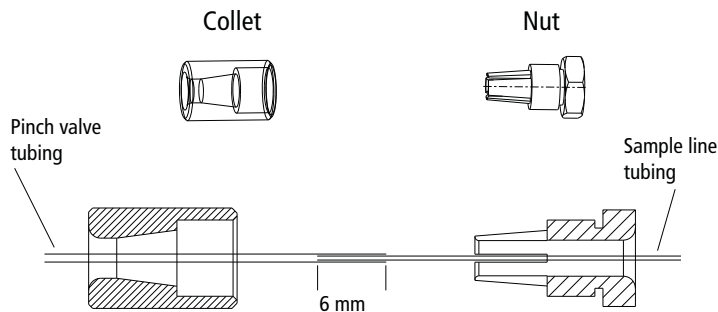

- 5 Install the new pinch valve tubing into the slots in the pinch valve and bubble detector.

Make sure that the tubing goes all the way into the back of each slot. The sample line can drip if the pinch valve tubing is not all the way into the slot in the pinch valve and the bubble detector.

Cleaning the Camera Windows

Lower Camera Window

Clean the lower camera window and the diode laser window when you have trouble viewing the side streams or you cannot set the drop delay using Accudrop.



A 12,000-volt potential exists between the deflection plates when they are on. Contact with the charged plates results in serious electrical shock. Do not touch the deflection plates when the plate voltage is on. The plates remain energized even when the sort block door is open.

To clean the lower camera window and the diode laser window:

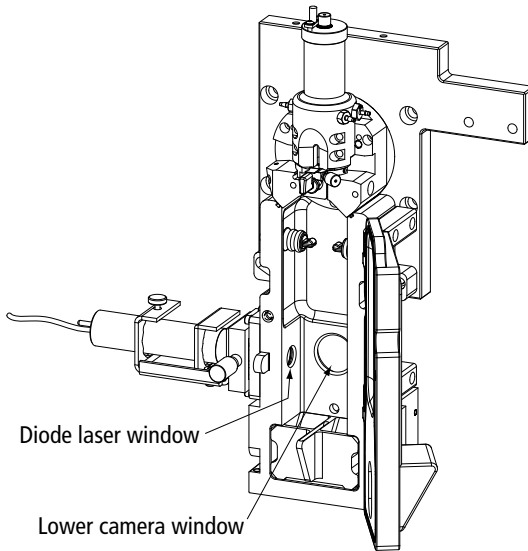

- 1 Ensure that the deflection plates are turned off (warning light is not illuminated).
- 2 Turn off the stream.
- 3 Open the sort block door.
- 4 Wipe the windows with a soft, lint-free cloth soaked with DI water, and then dry the windows (see Figure 6-28 on page 245).

Figure 6-28 Lower camera and diode laser windows



Upper Camera Window

Clean the strobe lens and upper camera window when smudges appear in the processed (digitized) image in the Breakoff window, or when dark spots appear to interfere with Sweet Spot monitoring. You might need to clean these components after a clog, or after sheath fluid has leaked or sprayed. Follow the steps in this section to clean the strobe lens and upper camera window.

  A 12,000-volt potential exists between the deflection plates when they are on. Contact with the charged plates results in serious electrical shock. Do not touch the deflection plates when the plate voltage is on. The plates remain energized even when the sort block door is open.

To clean the strobe lens and upper camera window:

- 1 Ensure that the deflection plates are turned off (warning light is not illuminated).

- 2 Turn off the stream.
- 3 Open the sort block door.
- 4 Place 1–2 drops of DI water or ethanol on a cotton swab.
- 5 Click the **Breakoff** window and select **Raw Image**.

Visible smudges are more apparent in the raw image view.

- 6 While viewing the image in the **Breakoff** window, insert the swab just below the bottom of the flow cell.

The strobe lens and upper camera windows are located behind two circular openings on either side of the top of the sort chamber. You will see the end of the swab in the Breakoff window when you intercept either opening.

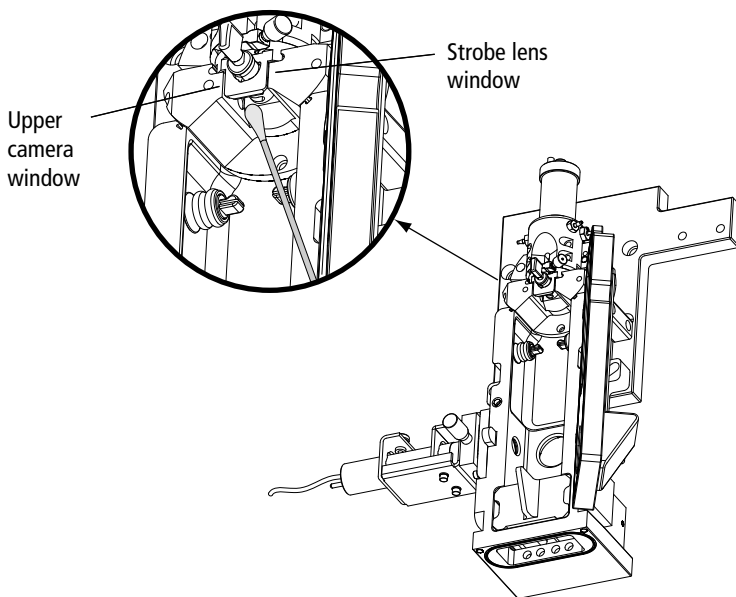

- 7 Gently wipe the upper camera window, and then the strobe lens (opposite the window) to remove any saline.

- 8 Repeat with isopropyl alcohol or 70% ethanol until clean.

Removing the Deflection Plates

You can remove the deflection plates for cleaning by pulling the plates out using the deflection plate removal tool, supplied in the accessory kit.

Figure 6-29 Deflection plate removal tool



- 1 Make sure that the deflection plates are turned off.
- 2 Open the sort block door.
- 3 Slide the deflection plate removal tool behind one of the plates and pull straight out from the sort block.

Hold your thumb on the plate (or use your other hand) as you pull it out so it does not fall as you remove it.

Figure 6-30 Using the deflection plate removal tool

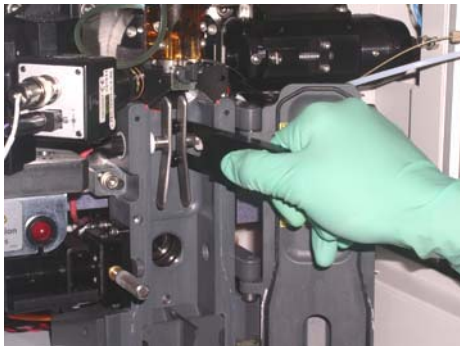

Lubricating the Sample Injection Chamber O-Ring

The O-ring at the bottom of the sample injection chamber should be lubricated as needed to maintain proper operation.

- 1** Verify that the loading port is in the down position, and open the hinged cover.
- 2** Check the O-ring (located at the opening in the bottom of the chamber) to see if it is dry.
- 3** If the O-ring is dry, it must be lubricated with O-ring lubricant from the accessory kit.
 - a** Remove the clear plastic tube holder from the tube holder base.
 - b** Apply a small amount of O-ring lubricant to the outside beveled edge of the tube holder base. This is where the base contacts the O-ring inside the sample injection chamber.
 - c** Wipe off any excess lubricant.
 - d** Replace the tube holder on the base.

Figure 6-31 Sample injection chamber with tube holder removed

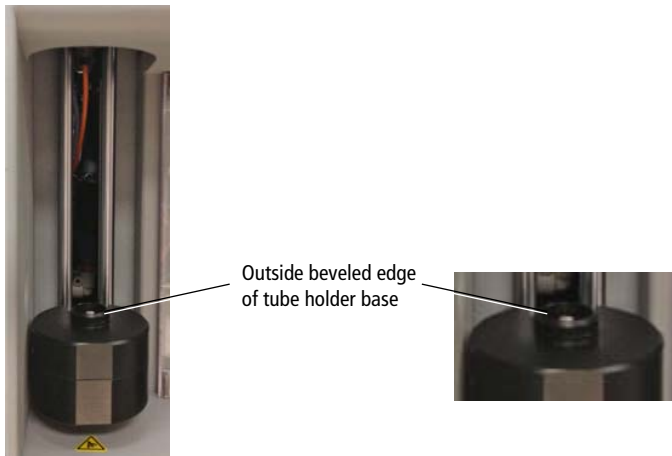

Using Custom Optical Filters

If you want to install a custom filter or dichroic, the filter should comply with the following specifications.

Table 6-4 BD FACSAria Fusion filter specifications

Filter Characteristic	Dichroic LP Filters	BP Filters
Diameter	0.622 ±0.003 in.	1.00 ±0.010 in.
Thickness	0.125 ±0.005 in.	0.12–0.35 in.
Minimum clear aperture	0.562 in.	0.85 in.
Incident angle	11 ±1°	0°

For the longpass filters, the surface that faces the center of the octagon or trigon should be coated directly on its surface, not between two or more pieces of glass. The coating should transmit >70% of the wavelength range you want the filter to transmit, with a minimum transmission of >50%, and it should reflect >90% of the wavelength range you want the filter to reflect.

The opposite surface (facing away from the center) should be coated with an anti-reflective coating with a minimum reflection of ≤1% of the wavelength range you want the filter to reflect.

Note that filters must be installed in front of each PMT to block unwanted laser light. For the dichroic, carefully assemble the glass filter in the holder using the retaining spring. Assemble the filter with the arrow pointing toward the center of the octagon or trigon. The angle of the dichroic is critical to achieving optimal results.

Note that any time you modify a detector array, you will need to create a new cytometer configuration to identify which PMT (identified by laser color and letter) will detect the emitted light. See Custom Configurations on page 92 for instructions.

Cleaning the Optical Filters

Optical filters should be inspected occasionally and cleaned as necessary. The frequency will depend on how often the filters are handled.



When cleaning or replacing a filter, handle with care to avoid scratching the surface and to prevent the filter from falling out of the holder. Use cotton swabs, optical lens paper, and spectral-grade methanol or absolute ethanol in a dropper bottle (do not use acetone) to clean the optical filters.

- 1 Wrap a triangular section of the lens paper around the cotton end of a cotton swab. Moisten and seal the end with a few drops of alcohol.
- 2 Holding the cotton swab in a horizontal position, gently rub any spots on the filter surface and wipe clean.
- 3 Allow the solvent to evaporate and check the filter surface for streaks.
- 4 Inspect a ¼-inch-diameter section in the center of the filter for scratches.

Filters are coated with different dielectrics that can get scratched. If you see scratches, replace the filter.

- 5 Insert the cleaned filter into the octagon or trigon.

Make sure the filters are pushed all the way in.

Removing or Installing the FSC ND Filter

For applications involving large particles in which events appear off scale on the FSC axis with a voltage of zero, keep the FSC ND filter in place to decrease the FSC signal and keep the events on scale. For applications involving small particles (for example, bacteria or platelets), you might need to remove the FSC ND filter as follows.

- 1 Open the flow cell access door.
- 2 Locate and pull out the FSC ND filter (Figure 6-32).

The filter is installed at the left end of the FSC detector block, just to the right of the flow cell. To remove the filter, loosen the set screw and pull the filter out of the slot.

Figure 6-32 Removing the FSC ND filter

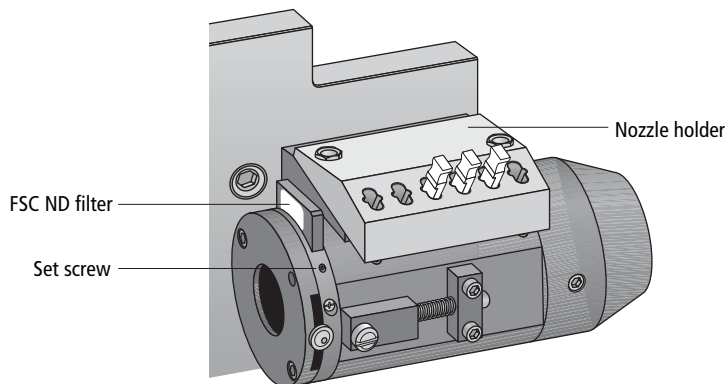

- 3 To reinstall the filter, slide it into the slot with the filter side down and the label facing the flow cell.

NOTE You can remove the nozzle holder to get better access to the ND filter slot.

THIS PAGE INTENTIONALLY LEFT BLANK

Troubleshooting

The tips in this chapter are designed to help you troubleshoot your experiments. Additional troubleshooting information can be found in the *BD FACSDiva Software Reference Manual*.

If additional assistance is required, contact your local BD Biosciences technical support representative. See Technical Assistance on page xv.

Troubleshooting suggestions in this chapter are grouped under the following headings:

- Troubleshooting the Stream on page 254
- Troubleshooting the Breakoff on page 259
- Sorting Troubleshooting on page 260
- Acquisition Troubleshooting on page 265
- Fluidics Troubleshooting on page 272
- Electronics Troubleshooting on page 274

Troubleshooting the Stream

Observation	Possible Causes	Recommended Solutions
Stream not in center of aspirator	Difference in keyed stream position between nozzles	If you have just changed the nozzle, use an Allen wrench to loosen the screws on either side of the sort block. Adjust the angle of the sort block until the stream flows into the center of the waste aspirator, and then tighten the screws. See Figure 1-11 on page 31.
	Nozzle inserted improperly	Turn off the stream. Remove the nozzle and ensure that the seal or O-ring is in place. Re-insert the nozzle and slide the nozzle in until it stops, then close the locking lever.
	Clogged or damaged nozzle	Turn off the stream, remove the nozzle, and examine the nozzle tip under a microscope. <ul style="list-style-type: none"> • If debris is visible, clean the nozzle. See Cleaning the Integrated Nozzle on page 233. • If the nozzle appears damaged, replace it. See Changing the Integrated Nozzle on page 231.
Performance check failed	Incorrect filters	You may have the incorrect filters on the 445 array or the 375/405 array. <ul style="list-style-type: none"> • Put the proper filters into the 445 array. • Swap the filters for the 580/20 array to run PE. For information about laser configurations, see Laser Options on page 285.

Troubleshooting the Stream (continued)

Observation	Possible Causes	Recommended Solutions
No stream or dripping stream	Nozzle inserted improperly	Turn off the stream. Remove the nozzle. See Changing the Integrated Nozzle on page 231 for instructions.
	Clogged or damaged nozzle	Turn off the stream, remove the nozzle, and examine the nozzle tip under a microscope. <ul style="list-style-type: none"> • If debris is visible, clean the nozzle. See Cleaning the Integrated Nozzle on page 233. • If the nozzle appears damaged, replace it. See Changing the Integrated Nozzle on page 231.
Stream control disabled or no stream when stream control clicked	Air lock in fluidics filter	Prime the system with the corresponding fluid. If the control is still disabled, remove the filter, install the bypass tubing, and repeat the priming procedure until you see fluid in the line. When fluid is running through the line, remove the bypass tubing, install the filter, and repeat the priming procedure one last time.
	Communication failure between workstation and cytometer	Exit the software and restart it.

Troubleshooting the Stream (continued)

Observation	Possible Causes	Recommended Solutions
No stream when Stream control clicked	Sheath tank low or empty	Refill the sheath tank. See Refilling the Sheath Tank on page 127. Note that when the empty tank warning message is not closed after 15 minutes, the stream shuts off automatically.
	Air in sheath line	Prime the sheath tank. See Prime After Tank Refill on page 213.
	Air in sheath filter	Purge the sheath filter. See Purging the Sheath Filter on page 218.
	Dry filter	Open the bleeder valve to purge the filter. See Purging the Fluid Filters on page 217.
Fanning around center stream	Nozzle inserted improperly	Re-insert the nozzle. Push it gently all the way forward without rocking it from side to side.
	House air or compressor is off (gauge reads zero)	Turn on house air or compressor.
	Sheath tank lid not properly seated (gauge reads <80 psi)	Remove sheath tank lid, reseal properly.
Unstable stream	Debris in flow cell or nozzle	Remove the nozzle and run the stream with no nozzle in place for approximately 10 seconds. (Click the Stream control on, then off.) Sonicate the nozzle and re-install it.
	Fluid line connected to ethanol shutdown tank	Move fluid and air lines to the sheath tank, then perform a fluidics startup. See Performing Fluidics Startup on page 119.

Troubleshooting the Stream (continued)





Observation	Possible Causes	Recommended Solutions
Leaking or spraying around nozzle	Defective or damaged integrated nozzle seal	Replace the defective seal with a standard O-ring. See Temporary Replacement of a Seal on page 236.
	Nozzle inserted improperly	Turn off the stream. Remove the nozzle. See Changing the Integrated Nozzle on page 231 for instructions.
	Extra O-ring is blocking the nozzle	Remove the nozzle and use a cotton swab to clear out the cuvette.
Drop breakoff is too long	Bubbles in flow cell	Open the flow cell access door and check for bubbles in the flow cell. If they are visible, turn off the stream, wait a few seconds, and turn on the stream again.
	Attenuation is on	Turn off attenuation.
	Amplitude is too low	Increase the amplitude until you can see drops. If you need a very high amplitude (>70 volts) to see drops, there might be air bubbles in the flow cell.
	Nozzle inserted improperly	Turn off the stream. Remove the nozzle and ensure that the seal or O-ring is in place. Re-insert the nozzle and slide the nozzle in until it stops, then close the locking lever.

Troubleshooting the Stream (continued)

Observation	Possible Causes	Recommended Solutions
Problems using Auto Delay feature	Stream is not stable	Make sure that the stream is stable before starting to run auto delay.
	Diode laser does not fully intercept the sorting streams	Adjust the diode laser to intercept streams in the middle, producing the biggest and brightest spots in the left and center images.
	Event rate is too low or too high	Adjust the flow rate to increase or decrease the event rate.

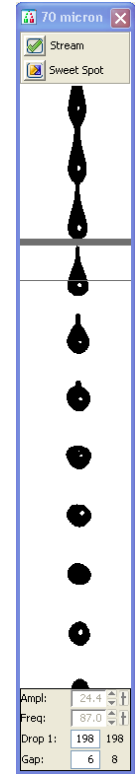
Troubleshooting the Breakoff

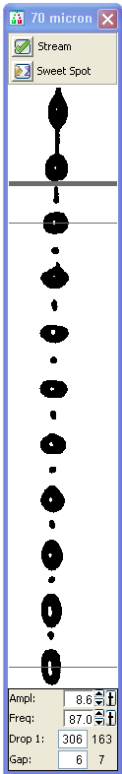
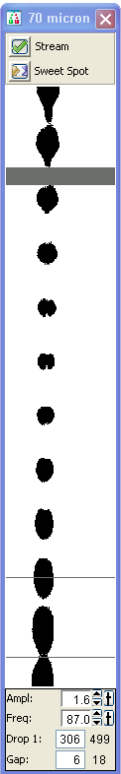
Use the following examples to help troubleshoot problems with the breakoff image.

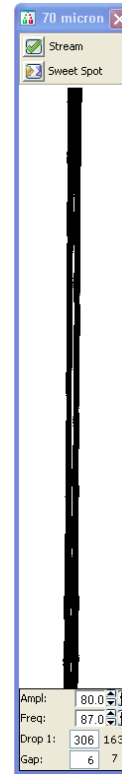
	Possible Causes	Recommended Solutions					
Normal stream image							
	Abnormal Stream Image						
			<p>Nozzle inserted improperly</p>	<p>Nozzle inserted improperly or orifice is off center</p>	<p>Partial clog</p>	<p>Wet or dirty strobe lens</p>	<p>Attenuation is on at wrong pressure</p>
			<p>Remove the nozzle and re-insert it.</p>	<p>Remove the nozzle and re-insert it.</p>	<p>Remove the nozzle, clean it, and then re-insert it.</p>	<p>Clean the lens as described in Cleaning the Camera Windows on page 244.</p>	<p>Turn off attenuation in the Side Stream window.</p>

Sorting Troubleshooting

Observation	Possible Causes	Recommended Solutions
Unstable breakoff while Sweet Spot is engaged	Residual ethanol in system	Allow the system to run until the breakoff stabilizes.
	Target Drop 1 value is out of range for drop spacing	Use an actual Drop 1 value for the target. Remember to repeat the drop delay setup each time the target value is changed.
	Nozzle is clogged or inserted improperly	See Responding to a Nozzle Clog During a Sort with the AMO on page 310.
	Dirty strobe lens or upper camera window	Clean the lens and the window as described in Cleaning the Camera Windows on page 244.
	Air in sheath filter	Purge the sheath filter. See Purging the Sheath Filter on page 218.
	Debris in flow cell or nozzle	Remove the nozzle and run the stream with no nozzle in place for approximately 10 seconds. (Click the Stream control on, and then off.) Sonicate the nozzle and re-install it.
Center stream image is dim or not visible in the Side Stream window	Camera window is dirty	Clean the lower camera window. See Cleaning the Camera Windows on page 244.
	Stream is not intercepting the diode laser	Adjust the micrometer dial on the laser to make the stream intercept as bright as possible. See Figure 1-22 on page 42.
Center stream is off center when the plate voltage is turned on	Voltage center too low or too high	Adjust the Voltage Center slider to put the center stream back to center.
	Saline spray on deflection plates or in sort block	Clean the deflection plates and the area around them.

Sorting Troubleshooting (continued)

Observation	Possible Causes	Recommended Solutions
Arcing between deflection plates	Salt bridge	Clean and dry the deflection plates and the area around and behind the plates.
ACDU sorting failure	Insufficient stream voltage	Increase the voltage for the far left stream.
	Splash shield not installed	Install the splash shield. See Installing the Sorting Hardware on page 192.
Side stream position reversal, where the streams appear to be associated with the wrong voltage slider.	Voltage sliders are set too far in or too far out.	Move sliders in or out so they control the correct side streams.

Sorting Troubleshooting (continued)

Observation	Possible Causes	Recommended Solutions
No deflection or insufficient deflection	Insufficient voltage	<ul style="list-style-type: none"> • Increase the side-stream voltages using the slider controls. • Increase the plate voltage.
	Stream-charging wire is loose or missing	Verify that the stream-charging wire is inserted all the way into the barb.
	Salt bridge	Turn off the stream. Remove the nozzle. See Changing the Integrated Nozzle on page 231 for instructions.
	Sorting paused because actual Drop 1 value is out of range	<p>Wait until the Sweet Spot adjusts the amplitude to achieve the Drop 1 target.</p> <p>If this happens repeatedly during sorting, there might be debris in the nozzle or flow cell. See Troubleshooting the Stream on page 254 for suggestions.</p>

Sorting Troubleshooting (continued)

Observation	Possible Causes	Recommended Solutions
Fanning around center or side streams	Nozzle inserted improperly	Turn off the stream. Remove the nozzle and ensure that the seal or O-ring is in place. Re-insert the nozzle and slide the nozzle in until it stops, then close the locking lever.
	Sweet Spot is off	Turn on the Sweet Spot.
	Incorrect sort precision mode	Verify that the sort precision mode is appropriate for your sorting requirements. See Sort Precision Modes on page 77.
	2nd, 3rd, or 4th Drop values not optimized	Adjust the 2nd, 3rd, and 4th Drop settings to tighten the center stream and fine-tune the side streams.
	Particles too big for nozzle	Change the nozzle. See Changing the Integrated Nozzle on page 231.
Sort button disabled	Current tube pointer not set to current tube	Click to move the current tube pointer to the appropriate tube.
Population not listed in Add menu on sort layout	Population defined using snap-to gate	Redefine the population using another gate type.
	Viewing sort layout for another tube	Open or create a sort layout for the current acquisition tube.
Sort layout counters not updating	Viewing sort layout for another tube	Open or create a sort layout for the current acquisition tube.
High sort conflict rate	Event rate is too high for drop drive frequency	Decrease the event rate.
	Gating conflict	Verify the gating hierarchy.
	Purity mask is too high	Decrease the purity mask.

Sorting Troubleshooting (continued)

Observation	Possible Causes	Recommended Solutions
Erratic sort rate	Flow rate is too high	Decrease the flow rate.
Unexpected sort results	Incorrect drop delay	Reset the drop delay. See Determining the Drop Delay – Automatic Method on page 181.
	Incorrect sort precision mode	Verify that the sort precision mode is appropriate for your sorting requirements. See Sort Precision Modes on page 77.
	Sweet Spot is off	Keep the Sweet Spot on during sorting.
	Drop 1 changed after setting drop delay	Reset the drop delay each time you change the Drop 1 value. See Determining the Drop Delay – Automatic Method on page 181.
	Laser delay changed after setting drop delay	Reset the drop delay each time you change the laser delay. See Determining the Drop Delay – Automatic Method on page 181.
	Incorrect logic in population hierarchy	Verify the gating strategy.
	Sorting parent and child populations into two different tubes	<p>If you try to sort a parent and its child population into two tubes, BD FACSDiva software ignores the child events in both tubes.</p> <p>Create a new subset under the parent population consisting of NOT (child). Sort the child population into one tube and the NOT (child) population into another tube.</p>

Acquisition Troubleshooting

Observation	Possible Causes	Recommended Solutions
No events in plots after clicking Load or Acquire Data	Current tube pointer is not set to current tube	Click to move the current tube pointer to the appropriate tube.
	Laser shutter is engaged	Make sure the flow cell access door is completely closed.
	Laser power is off	Turn on the laser power.
	Laser delay set incorrectly	Adjust the laser-delay settings. See Manual Adjustment of Laser Delay on page 164.
	Viewing plots for a different tube	Double-click the current tube in the Browser to display the plots for that tube.
	Incorrect population(s) in plot	Right-click the plot and select Show Populations. Verify that the appropriate populations are displayed.
	Uncolored events in plot	<ul style="list-style-type: none"> • Format the plot to display all events. • Assign a color to the population displayed in the plot. • Verify the population drawing order.
	Current cytometer configuration different from optical setup	Verify that the cytometer optics match the current cytometer configuration.
No sample in the tube	Add sample to the tube or install a new sample tube.	

Acquisition Troubleshooting (continued)

Observation	Possible Causes	Recommended Solutions
No events in plots after clicking Acquire Data (continued)	Sample is not mixed properly	Increase the sample agitation rate. See Sample Agitation on page 85.
	Sample line is clogged	Perform a sample line backflush. See Sample Line Backflush on page 212. If necessary, change the sample line.
	Sample filter is clogged	Replace the sample filter.
	Threshold not set to the correct parameter (usually FSC)	Set the threshold to the correct parameter for your application.
	Multiple threshold parameters not set correctly	Verify that the correct Boolean logic (And/Or) was used for the threshold parameters.
	Threshold channel too low or too high	Adjust the threshold channel. See Calculating Compensation on page 152.
	Optical filter(s) not completely seated	Make sure that the filters are pushed all the way in.
	FSC area scaling is incorrect	Ensure that the FSC-A matches the FSC-H value.
No fluorescence signal	Current cytometer configuration different from optical setup	Verify that the cytometer optics match the current cytometer configuration.
	Wrong filter installed or filter not completely seated	Make sure that the appropriate filter is installed for each fluorochrome. Make sure that the filters are pushed all the way in.
	Laser delay is set incorrectly	Adjust the laser-delay settings. See Manual Adjustment of Laser Delay on page 164.

Acquisition Troubleshooting (continued)

Observation	Possible Causes	Recommended Solutions
Low area signal	Area scaling is too low	Adjust area scaling for the corresponding laser. See Adjusting Area Scaling on page 143.
Unexpected events in plot	Incorrect logic in population hierarchy	Verify the gating strategy.
	Incorrect population(s) in plot	Right-click the plot and select Show Populations. Verify that the appropriate populations are displayed.
	Incorrect drawing order	Verify that the required population is not hidden by another population. Right-click the plot and select Order Populations by Count.

Acquisition Troubleshooting (continued)

Observation	Possible Causes	Recommended Solutions
Erratic event rate	Sample aggregates	Filter the sample.
	Bulk injection O-ring is worn	Contact your BD Biosciences service engineer.
	Sample is contaminated	Re-stain the sample, making sure the tube is clean.
	Sheath tank low	Fill the sheath container.
Unexpectedly high event rate	Threshold channel is too low	Adjust the threshold channel. See Calculating Compensation on page 152.
	Sample is too concentrated	Dilute the sample.
	Flow rate is too high	Decrease the flow rate in the Acquisition Dashboard.
	Bubbles in flow cell	Turn off the stream, wait a few seconds, and turn on the stream again.
Unexpectedly low event rate	Sample not adequately mixed	Increase the sample agitation rate. See Sample Agitation on page 85.
	Threshold channel is too high	Adjust the threshold channel. See Calculating Compensation on page 152.
	Sample is too dilute	Concentrate the sample.
	Sample line is clogged or kinked	Backflush the sample line. See Sample Line Backflush on page 212. If necessary, change the sample line.
		Look for visible kinks in the line. If kinks are found, change the sample line. See Changing the Sample Lines on page 221.

Acquisition Troubleshooting (continued)

Observation	Possible Causes	Recommended Solutions
Unexpectedly low event rate (continued)	Sample line installed incorrectly	Verify the sample line installation. See Changing the Sample Lines on page 221.
	Sample aggregates	Filter the sample.
	Memory is full	Compare the processed event rate in BD FACSDiva software with the threshold counter. If the event rate is much lower, exit and then restart the application.
Distorted populations or high CVs	Cytometer settings adjusted incorrectly	Optimize the scatter parameters. See Calculating Compensation on page 152.
	Flow rate is too high	Decrease the flow rate in the Acquisition Dashboard.
	Window extension is too low	Increase the window extension.
	Bubbles in flow cell	Turn off the stream, wait a few seconds, and turn on the stream again.
	Nozzle is clogged or dirty	Clean the nozzle as described in Changing the Integrated Nozzle on page 231.
	Flow cell is dirty	Clean the flow cell. See Cleaning the Flow Cell (Daily) on page 206. Let DI water sit for 15 minutes before turning on the stream. Repeat as needed.
	Poor sample preparation	Repeat sample preparation.
	Area scaling is too low	Verify area scaling. See Adjusting Area Scaling on page 143.

Acquisition Troubleshooting (continued)

Observation	Possible Causes	Recommended Solutions
Excessive amount of debris in plots	Threshold channel is too low	Increase the threshold channel. See Calculating Compensation on page 152.
	Dead cells or debris in sample	Examine the sample under a microscope.
	Sample is contaminated	Re-stain the sample, making sure the tube is clean.
High electronic abort rate (>10% of system event rate)	Window extension is too high	Decrease the window extension.
	Threshold channel is too low	Increase the threshold channel.
	Event rate is too high	Decrease the flow rate in the Acquisition Dashboard.
	Sample is aggregated	Filter the sample.
	Sample is too concentrated	Dilute the sample.
Fewer events than expected in gated population	Window extension set incorrectly	Adjust the window extension, if needed. See the <i>BD FACSDiva Software Reference Manual</i> for information.
	Laser delay set incorrectly	Adjust the laser-delay settings. See Manual Adjustment of Laser Delay on page 164.
	Plot is zoomed	Unzoom the plot or make the gate bigger.
	Events left out of the gate	When drawing a gate, make sure that events on the axis are included.

Acquisition Troubleshooting (continued)

Observation	Possible Causes	Recommended Solutions
Increasing threshold results in decreased area signal	Window extension is too low	Slightly increase the window extension to maximize the area signal. Increasing the window extension too much results in more electronic aborts or high CVs.
Area measurement off scale while the height measurement is on scale	Area scaling is too high	Decrease area scaling to move the area measurement back on scale. If necessary, adjust area scaling to make the area measurement match the height measurement.
Cannot delete from Parameters, Threshold, Compensation, or Ratio tab views	Row not selected	Select the row using the selection button.
	Data already recorded	Create a new tube.
Cannot connect to CS&T	External air supply is <80 PSI	Check the air pressure gauge on the air supply panel or sheath tank. The air pressure should be 80–100 PSI. <ul style="list-style-type: none"> • If the air pressure is within range, contact your BD Biosciences service engineer. • If the air pressure is <80 PSI, close the release valve and reseal the lid.
Negative Q values	Higher power lasers than in previous cell sorters	<ol style="list-style-type: none"> 1 Rerun the CST baseline. 2 When the software pauses at the Optimized PMT Results window, set median channel values that are <200 to 200. 3 Click OK to finish the run.

Fluidics Troubleshooting

Observation	Possible Causes	Recommended Solutions
No fluid in line during system prime	Air lock in sheath or fluidics filter	Remove the filter for the corresponding fluid, install the bypass tubing, and run Prime After Tank Refill. Repeat the priming procedure until you see fluid in the line. When fluid is running through the line, remove the bypass tubing, install the filter, and repeat the priming procedure one last time.
Prepare for aseptic sort fails	Air lock in filter	Remove the filter for the corresponding fluid, install the bypass tubing, and run Prime After Tank Refill. Repeat the priming procedure until you see fluid in the line. When fluid is running through the line, remove the bypass tubing, install the filter, and repeat the priming procedure one last time.
	Fluid line is detached	Verify the fluid line connections on the fluidics drawer and on the cytometer. Push firmly on each line to ensure that it is connected.
Fluidics air flow <80 PSI	Air leak	Contact your BD Biosciences service engineer.
Fluidics air flow >100 PSI	Regulator not adjusted properly	Contact your BD Biosciences service engineer.

Fluidics Troubleshooting (continued)

Observation	Possible Causes	Recommended Solutions
Fluid leak under fluidics drawer or below side door	Condensation from pressure relief valve	This is a normal phenomenon that occurs when water is condensed from room air. Condensation is greater in humid environments. To avoid slipping, wipe up any water daily.
	Bleeder valve is open	Check and close all bleeder valves for fluid and sheath filters.
	Broken fluid line	Contact BD Biosciences.
Sample injection chamber does not close and causes a BISH or BISO error message	O-ring at bottom of sample injection chamber is dry and causing chamber to stick	Lubricate the O-ring and tube holder. See Lubricating the Sample Injection Chamber O-Ring on page 248.

Electronics Troubleshooting

Observation	Possible Causes	Recommended Solutions
“Cytometer Disconnected” in Cytometer window	Cytometer power is off	Turn on the cytometer main power.
	Communication failure between workstation and cytometer	<ul style="list-style-type: none"> • Exit the software and then restart it. • If restarting does not work, reset the cytometer electronics: switch off the main power, wait 10 seconds until the system is fully depressurized, and then switch the power back on. • Restart the computer and the cytometer.
	Ethernet cable between workstation and cytometer is disconnected	Unplug and then plug in the cable connectors and make sure they are secure.
	IP address changed	Enter the correct IP address. Call BD Biosciences for assistance.
“Master DAQ Overflow” in Cytometer window	Event rate is too high	Decrease the event rate or verify the threshold.
	Dirty flow cell	Clean the flow cell. See <i>Cleaning the Flow Cell (Daily)</i> on page 206.
“Cytometer not responding” in Status tab	Unknown	Perform the suggestions for a communication failure, above.

Supplies and Consumables

This chapter provides a list of supplies and options that are available for the BD FACSAria Fusion cytometer.

- To order spare parts and consumables from BD Biosciences from within the US, call 877.232.8995 or go to bdbiosciences.com.

Outside the US, contact your local BD Biosciences representative.

- To order cytometer options, contact your sales representative.

This information is correct at the time of publication. For up-to-date information, see our website (bdbiosciences.com).

- Cytometer Supplies on page 276
- Consumables on page 282

Cytometer Supplies

Optical Components

The following filters and mirrors are mounted on the BD FACSAria Fusion cytometer. Use these part numbers if you need to order any replacement components. See Using Custom Optical Filters on page 249 for instructions.

Detector Array (Laser)	PMT	LP Mirror BP Filter	Replacement Part No.	Intended Dye
Octagon (488-nm blue laser)	A	735	343787	–
		780/60	343788	PE-Cy™7
	B	655	343789	–
		695/40	343790	PerCP-Cy5.5 or PI
		675/20	343791	PerCP
	C	610	640879	–
		616/23	640880	<ul style="list-style-type: none"> • PE-CF594 • PE-Texas Red®
	D	556	343794	–
		585/42	343796	PE or PI
	E	502	343797	–
		530/30	343798	FITC or Alexa Fluor® 488
	F	488/10	343799	SSC
		1.5 ND filter	53-10057-01	–

Detector Array (Laser)	PMT	LP Mirror BP Filter	Replacement Part No.	Intended Dye
Octagon (640-nm red laser)	A	735	343787	–
		780/60	19-62774-18	APC-Cy7 or APC-H7
	B	690	640468	–
		730/45	338830	–
	C	670/30	664620	APC or Alexa® Fluor 647

The following filters and mirrors are provided with the violet laser option.

Detector Array (Laser)	PMT	LP Mirror BP Filter	Replacement Part No.	Intended Dye
Octagon (405-nm violet laser)	A	502	343797	–
		510/50	649421	BD Horizon™ BV510, V500, Alexa Fluor® 430
	B	450/40	343801	DAPI, BD Horizon™ V450, Pacific Blue™, BD Horizon™ BV421, BD Horizon™ VPD450

The FSC photodiode is provided with a 1.5 and 2.0 ND filter. Other filters are available as options. Use the following part numbers to replace the filter.

Detector	ND Filter	Replacement Part No.
FSC photodiode	0.5	33710407
	1.0	33710807
	1.5	340104
	2.0	340105

To order a filter holder, use the following part numbers.

Holder	Part No.
Mirror holder	336103
Mirror retainer	345662
Mirror backup spring	344979
Filter holder	336102
Filter retainer	333830

Accessory Kit

The cytometer is shipped with an accessory kit containing the following items. Use these part numbers if you need to order any replacements.

Item	Part No.
1-mL microtube holder	333457
12 x 75-mm test tube holder	333456
15-mL centrifuge tube holder	333430

Item	Part No.
Four-way 1.5-mL Eppendorf collection tube holder	644349
Four-way 12 x 75-mm collection tube holder	641454
Two-way 12 x 75-mm collection tube holder	641613
Two-way 15-mL collection tube holder	641612
Universal top section for collection tube holders (2)	651439
O-ring for collection-tube holder (9)	337897
Integrated nozzles: <ul style="list-style-type: none"> • 70 micron (2) • 85 micron (2) • 100 micron 	<ul style="list-style-type: none"> • 647339 • 647340 • 647341
Nozzle locking lever (spring and plunger included)	7001349
Standard nozzle O-rings	333084
Nozzle holster	642884
Magnifying glass	337599
Sample injection tubing (12-inch lengths)	641059
Sample injection tubing (7-inch lengths)	641475
Ferrule	335108
Ferrule-removal tool	335690
Collet	19-66455-00
Collet nut	19-66456-00
Pinch valve tubing	641900
Sample line filters (35 micron)	649048
Sample line filters (50 micron)	649049
Sheath fluid filter (also used for ethanol shutdown tank filter)	331394

Item	Part No.
Fluid filter (for DI water, bleach, and ethanol tanks)	335916
Fitting, 1/4-28 x 1/16 barb PPL (3)	343508
Air filter, inline, 3 micron (2)	641913
Filter (Chroma) HQ710/50	640471
Mirror (Omega) 675/20	19-62774-15
Filter holders (3)	336102
Filter clip (5)	640563
Waste sensor probe (6-level)	334915
Disposable waste tank caps (pack of 12)	338854
Cap, waste tank (2 pack)	338505
Cap for 5-L container (3)	335916
Lubricant for O-rings	347306
O-ring pick tool	331430
O-rings (10)	340086
O-rings (3)	641860
O-ring, tank, ethyl and sheath	642877
Deflection plate removal tool	643197
Drop charge cable assembly	343358
Allen wrench set	98-10004-00
Adapter tray for microscope slides	335630
Swab, micro head 3.2 x 1.5 x 10, 70-mm LG (100/pkg)	643290
Cotton-tipped applicators (100/pkg)	99-30122-00
5-mL polystyrene round-bottom tubes (125/pkg)	343675
Warning labels	335600

Item	Part No.
Cable, extension, DB9FEM-DB (FEM, 8 feet)	332907
Power cords: <ul style="list-style-type: none"> • Main power cord • Cordset for continental Europe • Cordset for UK • Cordset for Australia/Asia 	<ul style="list-style-type: none"> • 333694 • 334140 • 334141 • 334175

Other Replacement Parts

The following items might be included in the accessory kit, but you can use the indicated part numbers to order spare or replacement parts.

Item	Part No.
Autoclavable 10-L container	340261
Auxiliary 5-L container	333504
Sheath sensor probe	64410907
Waste sensor probe (6-level)	334915
Auxiliary sensor probe (non-ethanol)	343835
Auxiliary sensor probe (ethanol)	642874
Air filter for ACDU cabinet (set of 3)	334821
ULPA filter and tubing replacement kit (set of 3, for use with the AMO)	334822
Hydrophobic filter for sort block door (for use with the AMO)	651177
Four-way 1-mL collection tube holder	641614

Consumables

Cytometer Setup Particles

Particle	Supplier	Catalog No.
BD Calibrite™ beads <ul style="list-style-type: none"> • Two-color kit (unlabeled, FITC, PE) • Three-color kit (unlabeled, FITC, PE, PerCP) • PerCP beads • PerCP-Cy5.5 beads • APC beads 	BD Biosciences	<ul style="list-style-type: none"> • 349502 • 340486 • 340497 • 345036 • 340487
Fluoresbrite® Yellow-Green 2-µm beads (for the 405-nm laser)	Polysciences Inc. (800) 523-2575	18604
Spherotech Rainbow Calibration Particles, 3.0–3.4 µm	BD Biosciences	<ul style="list-style-type: none"> • 559123 (8 peaks) • 556286 • 556291 (brightest peak in 556286)
BD FACS Accudrop beads	BD Biosciences	345249
BD FACSDiva CS&T research beads	BD Biosciences	655050 (1 vial) 655051 (3 vials)

Reagents

Reagent	Supplier	Catalog No.
BD FACST ^{Flow} sheath fluid	BD Biosciences	342003
BD TM FACSRinse detergent	BD Biosciences	340346
BD FACSClean solution	BD Biosciences	340345
Ethanol	Various	–
Chlorine bleach (5% sodium hypochlorite)	Clorox® or other major supplier (to ensure that the bleach is at the correct concentration and free of particulate matter)	–
Monoclonal antibodies	BD Biosciences ^a	–
Dyes and fluorochromes	Life Technologies (800) 438-2209 Sigma (800) 325-3010	–
BD FACST ^M lysing solution	BD Biosciences	349202

a. See the BD Biosciences Immunocytometry Products Catalog or the BD Biosciences website, bdbiosciences.com.

Labware

Item	Supplier	Catalog No.
1-mL microtubes	Bio-Rad Laboratories (800) 424-6723	223-9391 (1,000 per box)
1.5-mL Eppendorf tubes	Various	–
5-mL polystyrene test tubes, 12 x 75-mm <ul style="list-style-type: none"> • Uncapped, 125 per bag • Capped, 125 per bag • Capped, 25 per bag • With cell-strainer cap, 25 per bag 	BD Biosciences	<ul style="list-style-type: none"> • 343675 • 352054 • 352058 • 352235
15-mL conical centrifuge tubes <ul style="list-style-type: none"> • Polypropylene, 50/bag • Polypropylene, 125/bag • Polypropylene, 50/rack • Polystyrene, 125/bag • Polystyrene, 50/rack 	BD Biosciences	<ul style="list-style-type: none"> • 352196 • 352096 • 352097 • 352095 • 352099

9

Laser Options

BD FACSAria Fusion systems can be configured with up to six lasers, with four lasers active at one time. Depending on how your system is configured, you can choose different laser options by adjusting the laser rotary switches on your power panel.

You can view your system's configuration in the CS&T Cytometer Configurations window.

The following topics are described in this chapter:

- Planning Considerations on page 286
- Detector Locations on page 287
- Detector Configurations on page 289
- Fifth PMT in the 561-nm Octagon on page 301

Planning Considerations

When planning your experiments, keep in mind the specific combinations of lasers, mirrors, filters, and fluorochromes you need. You also have to properly account for the specific use of the 375-nm and the 445-nm lasers and how to name a particular fluorochrome if you want to use it with multiple lasers.

Optics Choices for the 375-nm Laser

The optics listed for the 375-nm laser are specifically intended for side population studies. For other experiments, you can use the optics from the 405-nm laser with the 375-nm laser.

Optics Changes When Using the 445-nm Laser

In a system with a 445-nm laser turned on, the BP filter for the 405-nm laser must be changed to 480/20 (from the standard 450/40). This is because the 405-nm laser detector picks up scattered light from the 445-nm laser and causes CS&T to produce incorrect results. This filter change applies to the 375-nm laser when using the same optics as the 405-nm laser.

Using a Fluorochrome with Multiple Lasers

If you plan to use a fluorochrome with more than one laser, you must create a unique name for each instance. For example, if PI is listed for a 561-nm laser on PMT C, you could list it as propidium iodide for the 375-nm laser on PMT B. You could also name them PI-561 and PI-375, or something similar, as long as the names are unique.

Detector Locations

The following tables list the detector locations with respect to the number of installed lasers. See Detector Configurations on page 289 for complete details about which mirrors, filters, and fluorochromes to use.

Table 9-1 2-laser systems

	Octagon Location			
Laser (nm)	Top Left	Top Right	Bottom Left	Bottom Right
488, 640	—	640	—	488

Table 9-2 3-laser systems

	Octagon Location			
Laser (nm)	Top Left	Top Right	Bottom Left	Bottom Right
488, 561, 640	—	640	561	488
488, 445, 640	—	640	—	488/445
488, 640, 405	405	640	—	488
488, 640, 375	375	640	—	488

Table 9-3 4-laser systems

	Octagon Location			
Laser (nm)	Top Left	Top Right	Bottom Left	Bottom Right
488, 561, 640, 405	405	640	561	488
488, 561, 640, 375	375	640	561	488
488, 445, 561, 640	—	640	561	488/445

	Octagon Location			
Laser (nm)	Top Left	Top Right	Bottom Left	Bottom Right
488, 445, 640, 405	405	640	—	488/445
488, 445, 640, 375	375	640	—	488/445
488, 640, 405, 375	375/405	640	—	488

Table 9-4 5-laser system

	Octagon Location			
Laser (nm)	Top Left	Top Right	Bottom Left	Bottom Right
488, 561, 640, 405, 375	375/405	640	561	488
488, 445, 561, 640, 405	405	640	561	488/445
488, 445, 561, 640, 375	375	640	561	488/445
488, 445, 640, 405, 375	375/405	640	—	488/445

Detector Configurations

This section lists four standard sets of detector configurations along with their mirrors, filters, and fluorochromes.

488/640 Two-Laser System

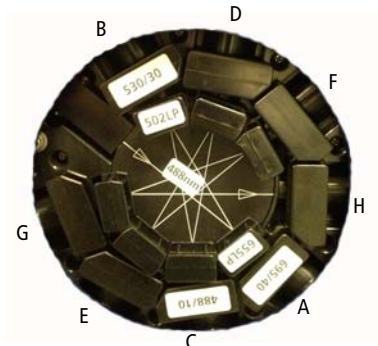

488-nm (blue) laser

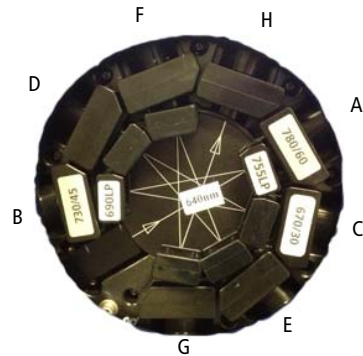

640-nm (red) laser

This is a basic two-laser system with two octagons.

Table 9-5 488/640 configuration

Laser and optics device	PMTs	LP mirrors	BP filters	Fluorochromes
488-nm octagon	A	735	780/60	PE-Cy7
	B	655	675/20 or 695/40	<ul style="list-style-type: none"> • PerCP • PerCP-Cy5.5
	C	610	616/23	<ul style="list-style-type: none"> • PE-CF594 • PE-Texas Red® • PI
	D	556	585/42	PE
	E	502	530/30	<ul style="list-style-type: none"> • FITC • Alexa Fluor® 488
	F	—	488/10	SSC
	G, H - Unavailable or optional			
640-nm octagon	A	735	780/60	<ul style="list-style-type: none"> • APC-Cy7 • APC-H7
	B	690	730/45	Alexa Fluor® 700
	C	—	670/30	<ul style="list-style-type: none"> • APC • Alexa Fluor® 647

Laser and optics device	PMTs	LP mirrors	BP filters	Fluorochromes
640-nm octagon	A	755	780/60	<ul style="list-style-type: none"> • APC-Cy7 • APC-H7
	B	690	730/45	Alexa Fluor® 700
	C	—	670/30	<ul style="list-style-type: none"> • APC • Alexa Fluor® 647
405-nm octagon	A	750	780/60	• BD Horizon™ BV786
	B	690	710/50	• BD Horizon™ BV711
	C	630	660/20	• BD Horizon™ BV650
	D	595	610/20	• BD Horizon™ BV605
	E	505	525/50	<ul style="list-style-type: none"> • AmCyan • BD Horizon BV510 • BD Horizon™ V500
	F	—	450/40	<ul style="list-style-type: none"> • DAPI • BD Horizon™ V450 • Pacific Blue™ • BD Horizon BV421 • BD Horizon VPD450
	G, H - Optional			

488(445)/561/640 Four-Laser System

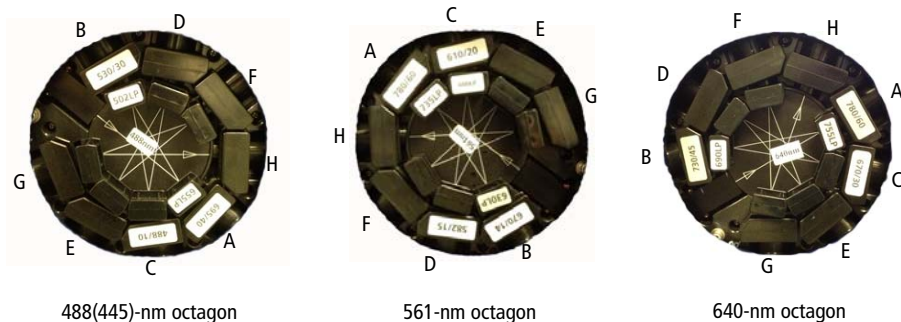

This four-laser system supports the simultaneous use of three lasers, with the option to switch from the 488-nm laser to the 445-nm laser. Note that there are three octagons: 488 nm/445 nm, 640 nm, and 561 nm.

Switching lasers affects the supported combination of mirrors, filters, and dyes. These laser options are included in the following table.

Table 9-7 488(445)/561/640 configuration

Laser and optics device	PMTs	LP mirrors	BP filters	Fluorochromes
488-nm octagon	A	655	675/20 or 695/40	<ul style="list-style-type: none"> PerCP PerCP-Cy5.5
	B	502	530/30	<ul style="list-style-type: none"> FITC Alexa Fluor® 488
	C	—	488/10	SSC
445-nm octagon (Optional)	A	470	510/80	<ul style="list-style-type: none"> CFP AmCyan fluorescent protein
	B	—	445/15	SSC
	C, D, E, F, G, H - Optional			

Laser and optics device	PMTs	LP mirrors	BP filters	Fluorochromes
561-nm octagon	A	735	780/60	PE-Cy7
	B	630	670/14 710/50	<ul style="list-style-type: none"> • PE-Cy™5 • PE-Cy5.5
	C	600	610/20	<ul style="list-style-type: none"> • PE-CF594 • PE-Texas Red® • Living Colors® mCherry • PI
	D	—	582/15	PE/Ds Red
	E, F - Optional			
	G, H - Unavailable			
640-nm octagon	A	735	780/60	<ul style="list-style-type: none"> • APC-Cy7 • APC-H7
	B	690	730/45	<ul style="list-style-type: none"> • Alexa Fluor® 700
	C	—	670/30	<ul style="list-style-type: none"> • APC • Alexa Fluor® 647

488(445)/640/405(375) Five-Laser System

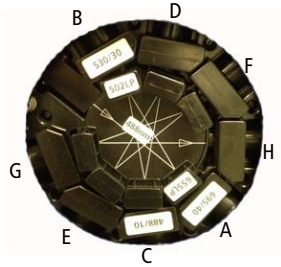

488(445)-nm octagon

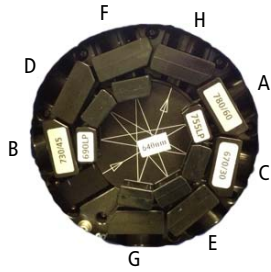

640-nm octagon

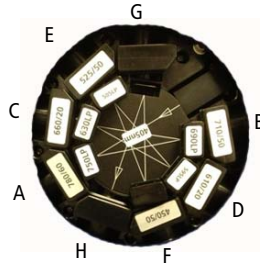

405(375)-nm octagon

This five-laser system supports the simultaneous use of three lasers, with the option to switch from the 488-nm laser to the 445-nm laser as well as from the 405-nm laser to the 375-nm laser.

If your system doesn't have the 445-nm or 375-nm laser installed, the location of the other detectors would not change.

Switching lasers affects the supported combination of mirrors, filters, and dyes. The laser options are included in the following table.

Table 9-8 488(445)/640/405(375) five-laser system

Laser and optics device	PMTs	LP mirrors	BP filters	Fluorochromes
488-nm octagon	A	735	780/60	PE-Cy7
	B	655	675/20 or 695/40	<ul style="list-style-type: none"> • PerCP • PerCP-Cy5.5
	C	610	616/23	<ul style="list-style-type: none"> • PE-CF594 • PE-Texas Red® • PI
	D	556	585/42	PE
	E	502	530/30	<ul style="list-style-type: none"> • FITC • Alexa Fluor® 488
	F	—	488/10	SSC
	G, H - Unavailable			
445-nm octagon (Optional)	A	470	510/80	<ul style="list-style-type: none"> • CFP • AmCyan fluorescent protein
	B	—	445/15	SSC
	C, D, E, F, G, H - Optional			
640-nm octagon	A	735	780/60	<ul style="list-style-type: none"> • APC-Cy7 • APC-H7
	B	690	730/45	Alexa Fluor® 700
	C	—	670/30	<ul style="list-style-type: none"> • APC • Alexa Fluor® 647

Laser and optics device	PMTs	LP mirrors	BP filters	Fluorochromes
405-nm/375- nm octagon	A	750	780/60	• BD Horizon BV786
	B	690	710/50	• BD Horizon BV711
	C	630	660/20	• BD Horizon BV650
	D	595	610/20	• BD Horizon BV605
	E	—	450/40 (480/20 with 445- nm laser)	• DAPI • BD Horizon V450 • Pacific Blue™ • BD Horizon BV421 • BD Horizon VPD450
	F	505	525/50	• AmCyan • BD Horizon BV510 • BD Horizon V500
	G, H - Optional			
375-nm octagon ^a (Optional)	A	610	670	• Hoechst Red
	B	—	450/20 (480/20 with 445- nm laser)	• Hoechst Blue • DAPI
	C - Optional			

a. Use these settings for the 375-nm laser for side population studies.

488(445)/561/640/405(375) Six-Laser System

This six-laser system supports the simultaneous use of four lasers, with the option to switch from the 488-nm laser to the 445-nm laser as well as from the 405-nm laser to the 375-nm laser. Switching lasers affects the supported combination of mirrors, filters, and dyes.

With this configuration, the 405-nm and 375-nm optics are interchangeable unless you are doing side population studies, in which case you'll use the optics specified for the 375-nm laser only.

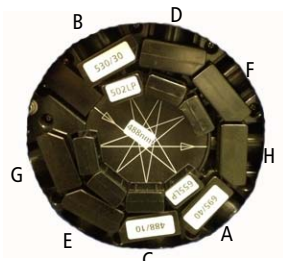

488(445)-nm octagon

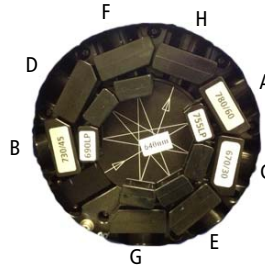

640-nm octagon

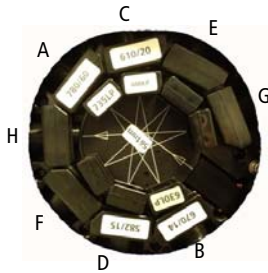

561-nm octagon

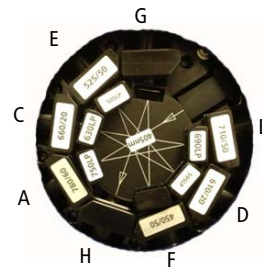

405(375)-nm octagon

Table 9-9 488(445)/561/640/405(375) configuration

Laser and optics device	PMTs	LP mirrors	BP filters	Fluorochromes
488-nm octagon	A	655	695/40 675/20	<ul style="list-style-type: none"> PerCP-Cy5.5 PerCP
	B	502	530/30	FITC
	C	—	488/10	SSC

Laser and optics device	PMTs	LP mirrors	BP filters	Fluorochromes
445-nm octagon (Optional)	A	470	510/80	<ul style="list-style-type: none"> • CFP • AmCyan fluorescent protein
	B	—	445/15	SSC
	C, D, E, F, G, H - Optional			
561-nm octagon	A	735	780/60	PE-Cy7
	B	630	670/14 710/50	<ul style="list-style-type: none"> • PE-Cy5 • PE-Cy5.5
	C	600	610/20	<ul style="list-style-type: none"> • PE-CF594 • PE-Texas Red® • Living Colors® mCherry • PI
	D	—	582/15	PE
	E, F - Optional			
	G, H - Unavailable			
640-nm octagon	A	735	780/60	<ul style="list-style-type: none"> • APC-Cy7 • APC-H7
	B	—	660/20	APC
	C - Optional			

Laser and optics device	PMTs	LP mirrors	BP filters	Fluorochromes
405-nm/375-nm octagon	A	750	780/60	<ul style="list-style-type: none"> • BD Horizon BV786
	B	690	710/50	<ul style="list-style-type: none"> • BD Horizon BV711
	C	630	660/20	<ul style="list-style-type: none"> • BD Horizon BV650
	D	595	610/20	<ul style="list-style-type: none"> • BD Horizon BV605
	E	505	525/50	<ul style="list-style-type: none"> • AmCyan • BD Horizon BV510 • BD Horizon V500
	F	—	450/40 (480/20 with 445-nm laser)	<ul style="list-style-type: none"> • DAPI • BD Horizon V450 • Pacific Blue™ • BD Horizon BV421 • BD Horizon VPD450
	G, H - Optional			
375-nm octagon ^a (Optional)	A	610	670	<ul style="list-style-type: none"> • Hoechst Red
	B	—	450/20 (480/20 with 445-nm laser)	<ul style="list-style-type: none"> • Hoechst Blue • DAPI
	C, D, E, F, G, H - Optional			

a. Use these settings for the 375-nm laser for side population studies.

Fifth PMT in the 561-nm Octagon

A system with a 561-nm laser and an optional fifth PMT includes a 685 LP mirror that can be used with the supplied 710/50 BP filter to run PE-Cy5.5. The optics in the PMTs need to be shifted to use this setup. The following drawing shows the optics configuration for this case.

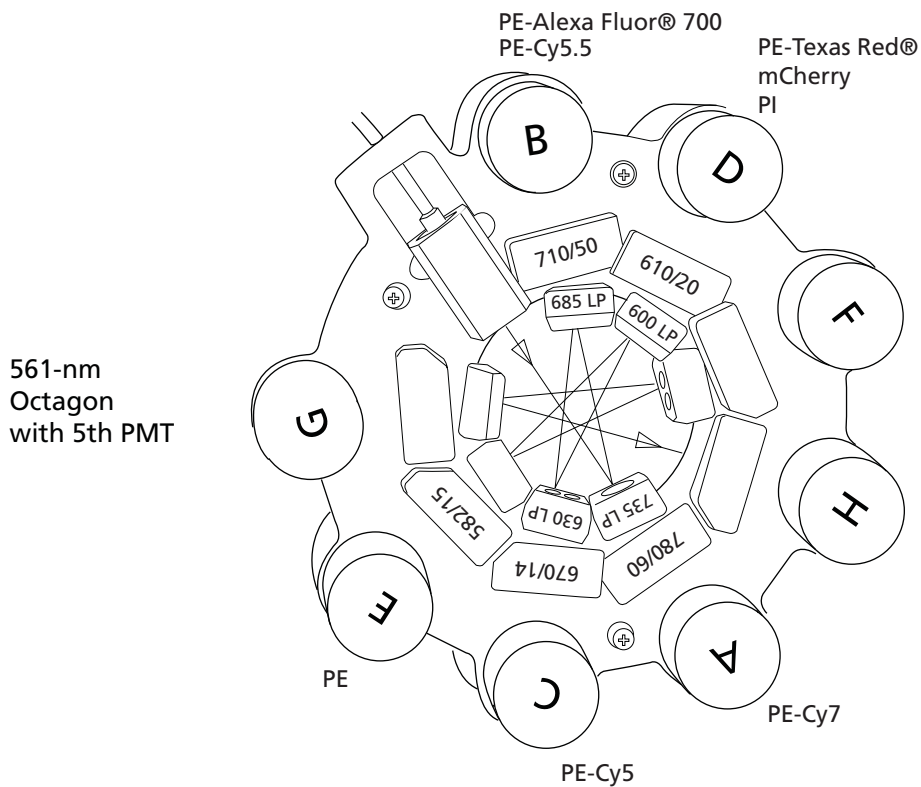

THIS PAGE INTENTIONALLY LEFT BLANK

BD Aerosol Management Option

The BD aerosol management option (AMO) is a device that uses an attached vacuum source to rapidly evacuate aerosolized particles through an ultra-low penetrating air (ULPA) filter during routine sorting or analysis.

The following topics are described in this chapter:

- Option Components on page 304
- Operating the BD Aerosol Management Option on page 306
- Maintenance on page 312
- Upgrades for the AMO on page 319
- Troubleshooting on page 320
- Specifications on page 323

Option Components

The BD Aerosol Management Option (AMO) includes the following:

- An evacuator to generate negative pressure
- An ULPA filter to trap particles, with attached tubing that connects the evacuator to the instrument
- An air filter for the sort collection chamber door
- A hydrophobic filter on the sort block door
- A hinged cover on the sample injection chamber



The BD Aerosol Management Option does not eliminate the health risks of working with biohazardous material and must be used in conjunction with good laboratory practice.

The BD Aerosol Management Option is For Research Use Only. It is not for use in diagnostic or therapeutic procedures.

Evacuator

The evacuator holds the ULPA filter and attached tubing. Air flow is controlled using pushbuttons within a membrane panel on the front of the unit. The evacuator sits on caster wheels for easy maneuverability. It can be moved using the handle attached to the unit. See Figure 10-1 on page 305.

Figure 10-1 AMO evacuator

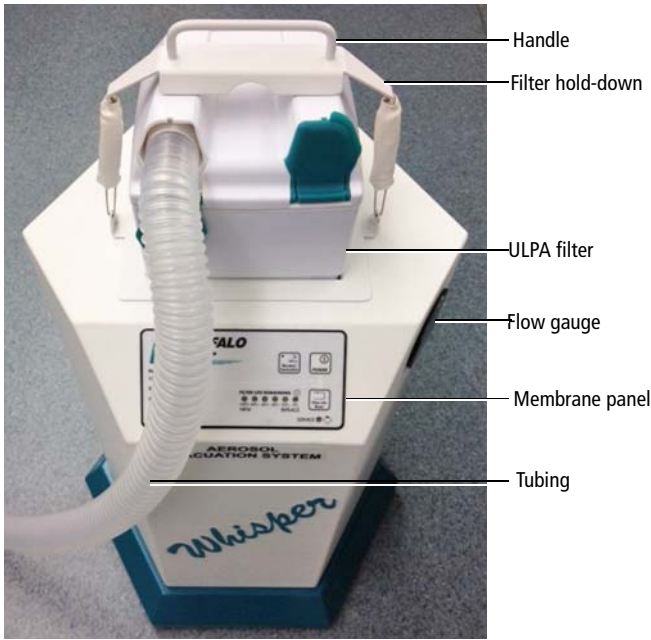

ULPA Filter

The ULPA filter used in the BD AMO captures and retains 99.9995% of all particles down to and including particles 0.12 microns in size, according to the manufacturer's specifications.

Figure 10-2 ULPA filter

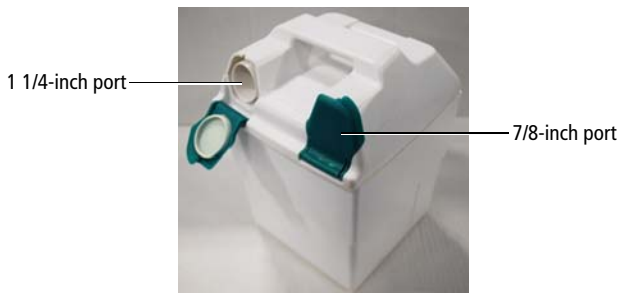

Operating the BD Aerosol Management Option

Starting Up the Evacuator

Before starting up the evacuator, make sure that:

- The ULPA filter is completely seated against the bottom of the evacuator filter well
- One end of the tubing is securely attached to the 1 1/4-inch (left) port on the ULPA filter

NOTE Ensure that the 7/8-inch (right) port is closed.

- The other end of the tubing is attached to the manifold located in the connection panel on the back of the cytometer



Any instrument surface that comes in contact with biological specimens can transmit potentially fatal disease. Use universal precautions when handling instrument hardware. Wear suitable protective clothing, eyewear, and gloves.

To start up the evacuator:

- 1** Install the splash shield or the tube holder below the aspirator drawer (Figure 10-3 on page 307).

The splash shield is required for sorting into a multiwell plate or onto a slide.

To install the splash shield:

- a** Close the sort block door and open the sort collection chamber door, if needed.

The sort block door must be closed to open the collection chamber door.

- b Remove the tube holder, if one is installed.
- c Insert the splash shield into the slotted fittings below the sort aspirator drawer. (See Figure 10-3.) Push the splash shield all the way in.

Figure 10-3 Installing the splash shield

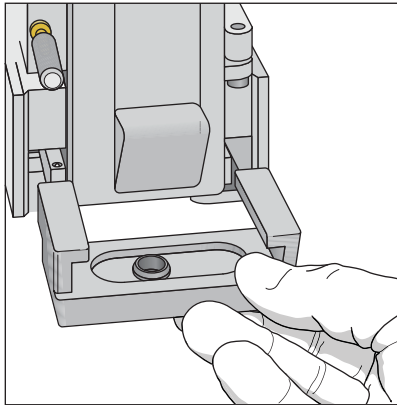

- 2 Ensure that an air filter is installed in the sort collection chamber door.

The filter traps airborne dust that could clog the ULPA filter. The filter should be changed on a monthly basis. See Replacing the Air Filter on page 317.

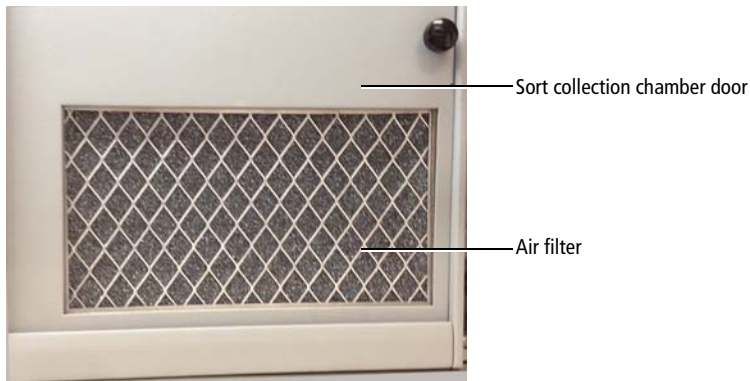

- 3 Close the sort collection chamber door.

NOTE The sort collection chamber door must be closed for the evacuator to generate negative pressure in the chamber.

- 4 Switch on the main power on the back of the evacuator (Figure 10-4).

Figure 10-4 Turning on main power

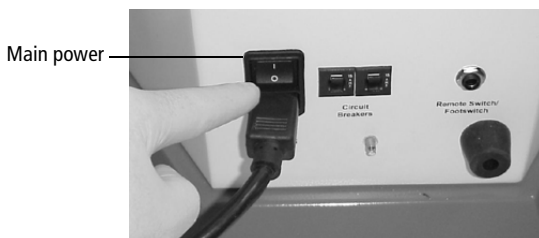

- 5 Press the power button on the membrane panel of the evacuator.



- 6 Press the up or down arrow button to set the suction control rate to 20%.

Each time either arrow button is pressed, the suction will increase or decrease by 10%. When two lights are lit on the suction control indicator, the actual air flow is the value between the two illuminated percentages.



Do not set the suction control rate above 20%. Higher rates could affect the stability of the side streams.

- 7 Verify that the filter flow gauge reads less than 2.4 inches of H₂O (Figure 10-5 on page 309).

For a new filter, the gauge should read 1.1–1.4 inches of H₂O. As the filter is used, the reading will increase. If the gauge reads 2.4 inches of H₂O or greater, replace the filter. See Replacing the ULPA Filter on page 313.

Figure 10-5 Reading the filter flow gauge

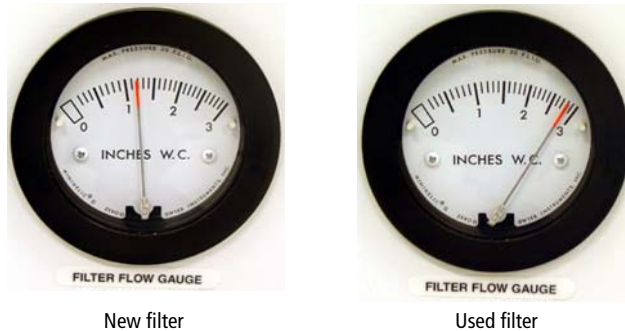

Setting Up for Sorting

To set up for sorting:

- 1 Start up the flow cytometer system. See Cytometer Startup on page 116.
- 2 Start up the evacuator as described in Starting Up the Evacuator on page 306.
- 3 Follow the standard sort setup procedure. See Setting Up for Sorting on page 170.

NOTE Always start up the evacuator before setting up for sorting. If you start up the evacuator after sort setup is complete, you will need to repeat the setup procedure.

Responding to a Nozzle Clog During a Sort with the AMO

If the stream is disturbed during the sort (due in part to a clogged nozzle), the sort is designed to stop automatically and block the sort tubes (if Sweet Spot is on). The sort will not restart until the operator has cleared the clog. In the event of a nozzle clog, do not open the sort collection chamber door or access the sort tubes before following this procedure.



Cell sorters that use droplet generation methods, such as the BD FACSAria Fusion, can produce aerosols around the sample stream. When acquiring biohazardous samples, follow universal precautions at all times. Keep the sort block door and the sort collection chamber door closed during sorting. Follow these steps to stop sample flow and evacuate potential aerosols before opening the sort collection chamber door.

To clear a clogged nozzle on a system with the AMO:

- 1 If the stream has not already shut down automatically, turn off the stream by clicking the **Stream** button (with a checkmark) at the top of the **Breakoff** window.

This will shut off the stream, unload the sample, and close the aspirator drawer.

- 2 Increase the air evacuation rate on the AMO unit to 100%.
- 3 Open the aspirator drawer using software controls (see Figure 1-12 on page 32).
- 4 Wait at least 60 seconds.

This procedure will clear aerosols from the sort chamber.

- 5 Close the aspirator drawer.
- 6 Turn on the stream and view the breakoff.

If the clog is removed, the breakoff will be similar to the breakoff before the clog.

- 7** If the clog is not cleared, turn the stream on and off several times to see if the clog will clear itself.
- 8** If the clog is not removed, turn the stream off and perform the Clean Flow Cell procedure with DI water (see *Cleaning the Flow Cell (Daily)* on page 206), followed by turning the stream on to see if the clog has cleared.
- 9** Open the aspirator drawer and evacuate for at least 60 seconds before closing the aspirator drawer again.
- 10** You can now open the sort collection chamber and remove the sort collection device.
- 11** If it is necessary to change nozzles or remove a clog from a nozzle, see *Cleaning the Integrated Nozzle* on page 233.
- 12** With stream turned off, open the sort block door and dry the plates and surfaces as needed.
- 13** When removing collection tubes, be aware that the outside of the tube is potentially contaminated. Use alcohol swabs or bleach to wipe the outsides of tubes.
- 14** Set the AMO unit back to 20% vacuum.
- 15** Make sure that all chamber doors are closed and restart the stream.
- 16** Perform these tasks if needed:
 - Turn on the Sweet Spot
 - Check the drop delay
 - Check the side stream deflection

Turning Off the Evacuator

Turn off the evacuator after you have finished running biohazardous samples.

- 1 Place the system in standby by pressing the power button on the membrane panel of the evacuator.
- 2 Switch off the main power on the back of the evacuator (Figure 10-4 on page 308).

Maintenance

Use the following guidelines to ensure optimal performance of the BD Aerosol Management Option.

- Change the ULPA filter and attached tubing when the flow gauge indicator is >2.4 at a 20% flow setting or when the red filter-life indicator LED is blinking. See Replacing the ULPA Filter on page 313.

Two spare filters and replacement tubing are included with the AMO. To order additional replacement kits, contact your local BD Biosciences representative.



- All biological specimens and materials coming into contact with them can transmit potentially fatal disease. Handle the ULPA filter and attached tubing as if capable of transmitting infection. Dispose of waste using proper precautions and in accordance with local regulations. Wear suitable protective clothing, eyewear, and gloves.
- Change the air filter in the sort collection chamber door on a monthly basis. The filter traps airborne dust that could clog the ULPA filter. Regular replacement of the air filter will extend the life of your ULPA filter. See Replacing the Air Filter on page 317.
 - Do not touch the Filter Life Reset button during normal operation. Doing so could shut down the evacuator and prevent the collection of aerosols.

- Do not disconnect the tubing from the instrument manifold outlet or the ULPA filter unless you are changing the filter. Repeated removal and reattachment of the tubing could loosen the connection and disrupt airflow.
- To ensure optimal airflow, keep the tubing free of kinks and away from sharp or heavy objects. Do not crush or puncture the tubing. Ensure that the tubing is securely attached at both ends before turning on the evacuator power.
- Keep the sort collection chamber free of potentially obstructive debris, such as Kimwipes® or disposable pipets.
- Replace the hydrophobic filter on the sort block door every six months. See Figure 1-13 on page 33 for the location of the filter.

Replacing the ULPA Filter

Replace the filter when either of the following conditions occur:

- The filter-flow gauge reads 2.4 inches of H₂O or greater at 20% suction.
- The red filter-life indicator LED is blinking.

NOTE When only the red LED light is illuminated (but is not blinking), you have approximately 1 hour of filter life remaining. If the red light comes on during sorting, the filter will not stop working. Replace the filter as soon as possible when the red light starts blinking.

To replace the ULPA filter:

- 1 Turn off the evacuator main power and disconnect the electrical plug.



To prevent potential shock, always turn off the evacuator main power and disconnect the electrical plug from the power source before installing or removing any filter.

- 2 Disconnect the tubing from the manifold.

The manifold is located in the connection panel on the back of the cytometer.

- 3 Remove the spring-loaded filter hold-down.

While pushing down on the filter, pull up on the spring-loaded handle (Figure 10-6A), and guide the handle over the top of the filter and behind the metal plate in the back of the evacuator (Figure 10-6B).

NOTE The photos in this section show the discontinued ULPA filter. The new ULPA filter has two ports (1 1/4-inch and 7/8-inch). See Figure 10-2 on page 305.

Figure 10-6 Removing the filter hold-down

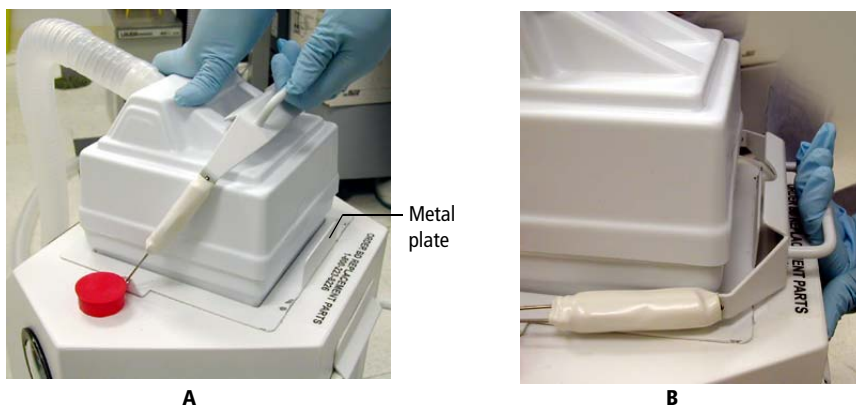

- 4 Lift off the ULPA filter and attached tubing from the evacuator and dispose of both the filter and the tubing.



All biological specimens and materials coming into contact with them can transmit potentially fatal disease. Handle the ULPA filter, attached tubing, and all instrument hardware as if capable of transmitting infection. Dispose of waste using proper precautions and in accordance with local regulations. Wear suitable protective clothing, eyewear, and gloves.

- 5 Insert the new ULPA filter into the evacuator filter well (Figure 10-7 on page 315).

Figure 10-7 Inserting the new filter



- 6 Push down on the filter to ensure that it is seated against the bottom of the filter chamber (Figure 10-8).

Figure 10-8 Seating the new filter



NOTE For optimal evacuation of aerosols, the filter must be completely seated in the evacuator filter well.

- 7 Lift the spring-loaded filter hold-down and place it on top of the filter.
- 8 Press and hold the Filter Life Reset button on the membrane panel for 5-10 seconds (Figure 10-9 on page 316).

Figure 10-9 Filter Life Reset button



All of the green, amber, and red LED lights will turn off, and then on. Hold down the button until the 100% indicator light is lit. This resets the 180-hour filter-life clock.

NOTE As the life of the filter is exhausted, the indicator lights will go out, starting from 100%. When only the red LED light is illuminated (but is not blinking), you have approximately 1 hour of filter life remaining.

- 9 Connect one end of the replacement tubing to the 1 1/4-inch (left) port on the ULPA filter (Figure 10-10), and the other end to the tubing manifold on the back of the cytometer.

Ensure that the cover on the 7/8-inch (right) port is closed. See Figure 10-2 on page 305.

Figure 10-10 Connecting new tubing to the ULPA filter



NOTE For optimal evacuation of aerosols, ensure that the tubing is securely connected at both ends.

- 10 Connect the evacuator power plug to the power source.

Replacing the Air Filter

To extend the life of your ULPA filter, we recommend that you replace the air filter on a monthly basis. The filter traps airborne dust that could clog the ULPA filter. Regular replacement of the air filter will extend the life of your ULPA filter.

The air filter is located inside the sort collection chamber door.

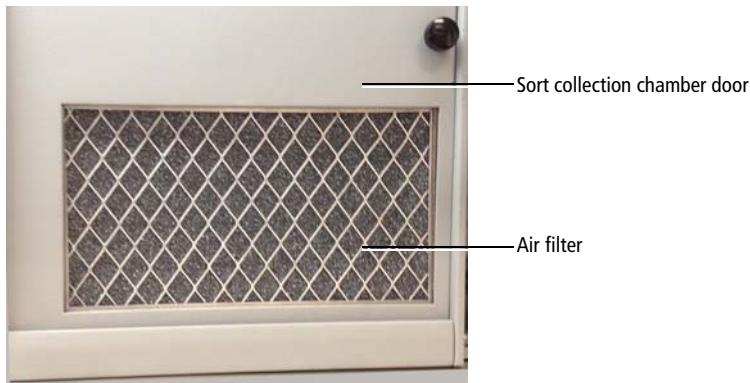

To replace the air filter:

- 1 Slide open the sort collection chamber door.

The air filter is held in place by a cover. See Figure 10-11 on page 318.

Figure 10-11 Removing the air filter



- 2 Unscrew the screw at the top of the cover.
- 3 Pull off the cover and slide out the air filter.

Grasp the filter and then carefully slide it out of the door. While it is still inside the BSC, bag the air filter to avoid exposure to biohazardous agents.



All biological specimens and materials coming into contact with them can transmit potentially fatal disease. Handle the air filter and all instrument hardware as if capable of transmitting infection. Dispose of waste using proper precautions and in accordance with local regulations. Wear suitable protective clothing, eyewear, and gloves.

- 4 Install a new air filter in the door.

Slide the new filter in from the right.

NOTE Make sure to install the filter with the grid side facing out so that it is visible through the closed door (Figure 10-12 on page 319).

Figure 10-12 View of the air filter from the top and bottom



Grid side faces out



Non-grid side faces inside

- 5 Reinstall the cover and tighten the screw.

Upgrades for the AMO

Upgrade kits are available for the AMO to improve the efficiency of the system to clear aerosols that can be produced during the sorting process. The components include a new universal tube holder top section with three holes (Figure 10-13) and a new sort block door with a hydrophobic filter (Figure 10-14 on page 320).

Contact BD Customer Support for information on the upgrade kits.

Figure 10-13 Universal tube holder top

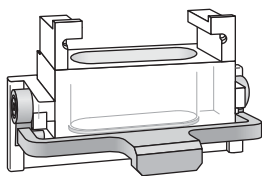

Universal top (front view)

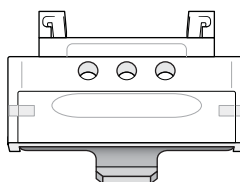

Universal top (back view)

Figure 10-14 Sort block door with filter

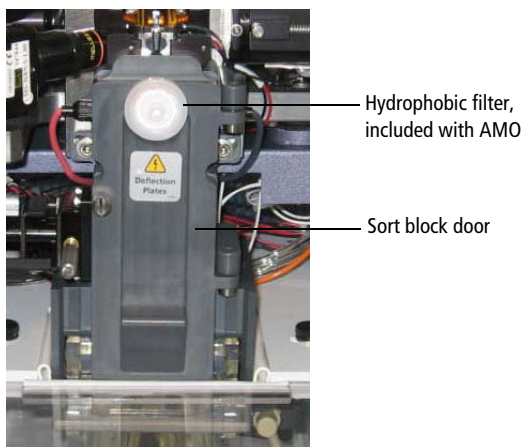

Troubleshooting

The tips in this section are provided to help you troubleshoot issues that arise when using the BD Aerosol Management Option. For cytometer-specific troubleshooting, see Troubleshooting on page 253.

If additional assistance is required, contact your local BD Biosciences technical support representative or supplier.



If any of the following are observed, assume that the AMO is not evacuating properly, and do not open the doors to the sort chamber.

Control Panel Troubleshooting

Observation	Possible Cause	Recommended Solution
Evacuator indicator lights off	Evacuator power cord unplugged	Connect the evacuator power cord to the power source.
	Evacuator power switched off	Switch on the evacuator main power. See Figure 10-4 on page 308.
	Evacuator motor failure	Contact your local BD technical support representative.
	Circuit breaker tripped	Depress the circuit breaker on the rear of the evacuator into its original position.
	Site power failure	Turn off the evacuator power switch and wait for site power to be restored.
Evacuator indicator lights pulsing	Erratic power source	Plug the power cord into a different outlet.
Arrow keys not responding	Improper operation	Push each button firmly before removing your finger from the control.
	Defective membrane panel	Contact your local BD technical support representative.
Red filter-life indicator light on	Approaching 180 hours of filter use	Monitor the light. When it blinks, change the filter.
	Filter life not reset after filter change	After changing the filter, press and hold the Filter Life Reset button until the 100% indicator light is lit.
Red filter-life indicator blinking	Filter used over 180 hours	Replace the filter.

Filter Flow Gauge Troubleshooting

Observation	Possible Cause	Recommended Solution
Zero reading on filter flow gauge	Power off	Press the power button on the membrane panel of the evacuator.
	Filter defective	Replace the filter.
	Filter improperly seated in evacuator	Re-seat the filter with the evacuator power off.
	Tubing loose or not connected	Ensure that the tubing is securely connected below the sort chamber and to the filter module.
	Tubing kinked or damaged	Inspect the tubing for kinks or punctures. Replace the tubing, if needed.
	Wrong tubing type or part	Ensure that the correct type of tubing is in use.
Erratic reading on filter flow gauge	Defective filter	Replace the filter.
	Filter improperly seated in evacuator	Re-seat the filter with the evacuator power off.
Off-scale reading on filter flow gauge	Tubing or sort collection chamber obstructed	<ul style="list-style-type: none"> Inspect the tubing for kinks or punctures. Replace the tubing, if needed. Check for obstructions in the sort collection chamber. Remove any obstruction.
	Filter clogged or saturated	Replace the filter as described in Replacing the ULPA Filter on page 313.

Specifications

Specifications for the BD Aerosol Management Option are as follows.

Evacuator

- Greater than or equal to 7 CFM (ft³/min) normal operation rate (20% suction control)
- Greater than or equal to 30 CFM boost evacuation (100% suction control)
- <35 lb unpacked weight

ULPA Filter Module

- VLSI grade
- Traps particles greater than or equal to 0.12 µm
- Three-stage filtration (pre-filter, ULPA, post-filter)
- Particulate removal efficiency >99.9995%

Air Filter

- Filter medium is an open-cell polyurethane foam
- Medium specially coated for improved fire retardation and fungi resistance
- High dust-trapping capacity, low air resistance
- Can be used in a wide variety of climatic conditions
- Rated UL 94 HF-1

THIS PAGE INTENTIONALLY LEFT BLANK

Biosafety Cabinet Option

The following topics are covered in this chapter:

- Biosafety Cabinet Overview on page 326
- Aerosol Management System on page 333
- Operating the AMS on page 335
- Working in the BSC on page 338
- Cleaning the Base Pan on page 340
- Replacing the Electronics Cable Plastic Sleeve on page 343
- Ergonomics Safety Guidelines on page 344

Biosafety Cabinet Overview

The optional biosafety cabinet (BSC) is designed to be used with the BD FACSAria Fusion, with the sorting hardware located inside the BSC (Figure 11-1). Biosafety protection is provided by negative pressure and controlled air flow within the cabinet. Before entering the work area or leaving the top of the cabinet, air passes through high-efficiency particulate air (HEPA) filters. An integrated Aerosol Management System (AMS) operates independently from the BSC blower and provides additional biosafety protection. The AMS evacuates the sort chamber during sorting and exhausts that air through a separate HEPA filter. Air flow probes in the BSC and AMS monitor exhaust air flow. An audible alarm is triggered if the air pressure differential (BSC) or air flow (AMS) drops to an unsafe level.

Figure 11-1 The BSC enclosing the BD FACSAria Fusion

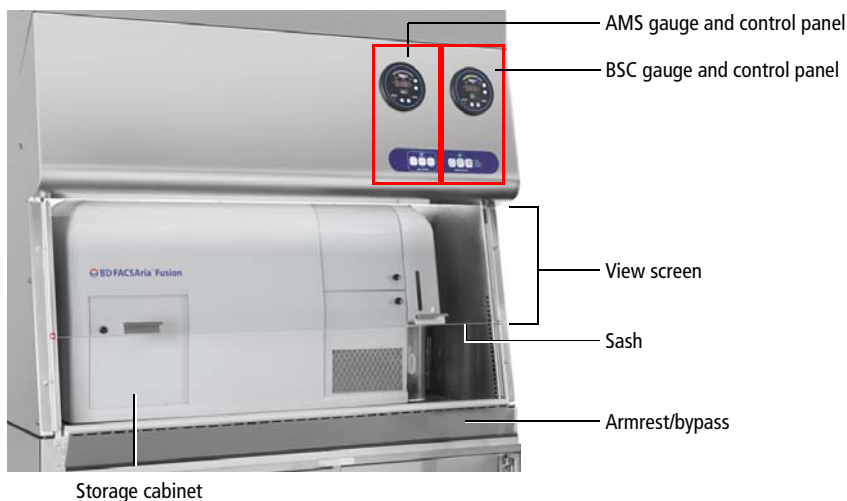

Operating the BD FACSAria Fusion inside the BSC can generate temperatures above the acceptable range of 17.5°C–22.5°C (63.5°F–72.5°F). Monitor the temperature inside the BSC to ensure that it does not exceed this range.

An optional FlexAIR® canopy can be purchased to connect the BSC to an in-house exhaust system (Figure 11-2). The FlexAIR canopy can help alleviate

excess heat inside the BSC. Lowering the temperature inside the lab will also help keep the temperature down.

Figure 11-2 FlexAIR canopy installed on the BSC

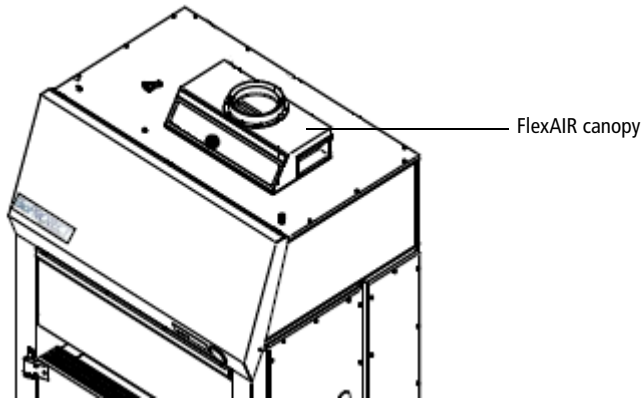

For safety information about the BSC, see the *BD FACSAria Fusion Safety and Limitations Guide*. Additional BSC information not contained in this guide can be found in The Baker Company *Biosafety Cabinet for BD FACSAria Fusion Operator's Manual*.

View Screen

The view screen is made from safety plate glass and is the barrier between the BSC work area and the user.

- Maximum opening: The view screen can be opened to a maximum of 18 inches to allow temporary full access to the work area.
- Minimum opening: The view screen can be fully closed.

Sash

The sash is the bottom edge of the view screen. Grip the sash and slowly:

- Pull down to close the view screen
- Push up to open the view screen

Safe Work Access Opening



The safe work access opening is 8 inches, which provides biosafety protection. If the sash is raised above 8 inches for more than 3 seconds, an alarm sounds.

The safe work access opening is marked by a red arrow located on both sides of the BSC frame. Ensure that the sash is at this level each time you work in the BSC.

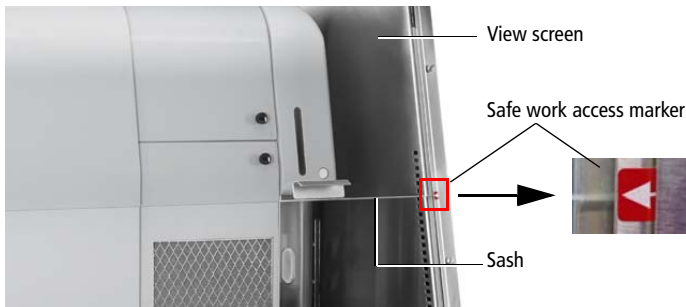

Ready Safe Mode

The ready safe mode is an energy saving mode for when the BSC is not in use. To put the BSC in ready safe mode:

- Keep the blower on.
- Lower the sash to fully close the view screen.
- Check the differential pressure gauge to verify that the pressure decreases. (See Differential Pressure Gauge on page 330 for more information.)

We recommend that you leave the BSC in ready safe mode when it is not being used.

Storage Cabinet

A storage cabinet is located on the left side of the BD FACSAria Fusion. Use the cabinet to store sample racks and tubes, squirt bottles, and other similar items to prevent obstruction of air flow. Open the door by gripping the knob and sliding it to the right.

Cabinet Gauge and Controls

The BSC differential pressure gauge and cabinet controls are located on the front of the BSC in the lower right corner. (The BSC and AMS controls are located on the same panel.) The BSC controls are on the right side of the panel (Figure 11-3).

Figure 11-3 BSC Differential Pressure Gauge and Control Panel

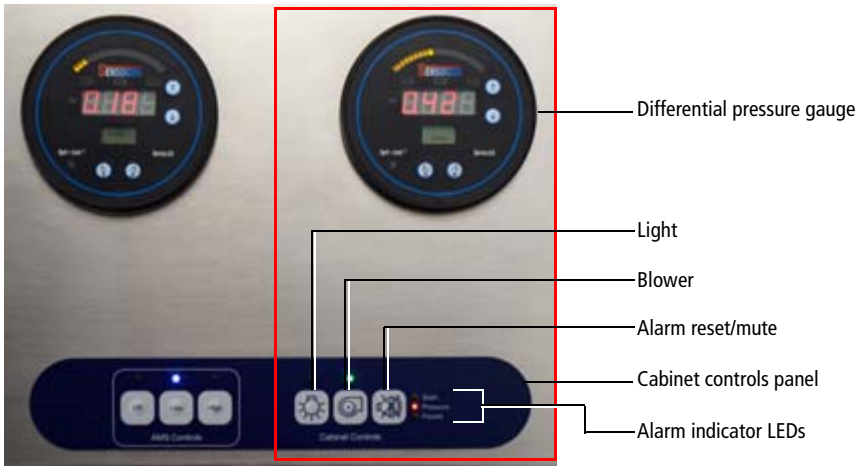

Differential Pressure Gauge

The differential pressure gauge displays the difference in air pressure inside the BSC vs outside the BSC, measured in inch water column (inch WC). The reading should be the value obtained during certification $\pm 20\%$. (See your BSC certification paperwork.) If the value drops below this level, the pressure alarm will sound and an orange indicator LED will flash. See Buttons and LED Indicators on page 331.

Buttons and LED Indicators

The following table describes the function of the BSC control buttons and the meaning of the LED indicators located above each button.

Button	Function	LED indicates	LED color	Comments
Light	Turns the light on and off	Power is on	Blue	Two fluorescent lamps light the work area.
Blower	Turns the blower on and off	Power is on	Green	The blower creates the air flow patterns inside the BSC.
		Power is off	Flashing green	–
Alarm	Mutes the alarm for 5 minutes or resets it	See LED Alarm Indicators.		

LED Alarm Indicators

LED indicators to the right of the Alarm button are illuminated when there is an alarm condition. The following table describes the LEDs and conditions that trigger them.

Alarm	LED Color	Condition
Sash	Flashing red	<ul style="list-style-type: none"> • The sash is raised above the 8-inch safe opening height. • The sash is lowered to fully close the view screen (until the pressure decreases).

Alarm	LED Color	Condition
Pressure	Flashing orange	<ul style="list-style-type: none"> The air pressure differential drops to an unsafe exhaust airflow level. The air pressure differential has not reached the proper level. (This occurs when the blower is first turned on.)
	Solid orange	The air pressure problem was corrected. Press the alarm button to reset the alarm.
FlexAIR ^a (if installed)	Flashing yellow	The air flow through the canopy drops to an unsafe level.

a. The optional FlexAIR canopy can be purchased to connect the BSC to an in-house exhaust system.

Audible Alarms

An LED indicator to the right of the alarm button is illuminated when there is an alarm condition. Audible alarms differ for each alarm type. The following table describes the alarms and conditions that trigger them.

LED Indicator	Audible Alarm	Condition
Sash	Sounds once per second.	The sash is positioned at an unsafe level for more than 3 seconds.
Pressure	Sounds four times per second followed by a two-second delay.	<ul style="list-style-type: none"> The air pressure differential drops to an unsafe exhaust air flow level. The air pressure differential has not reached the proper level. (This occurs when the blower is first turned on.)
FlexAIR ^a (if installed)	Sounds two times per second.	The air flow through the canopy drops to an unsafe level.

a. The optional FlexAIR canopy can be purchased to connect the BSC to an in-house exhaust system.

For detailed instructions on how to use the BSC, what the alarm conditions indicate, and how to reset them, see The Baker Company *Biosafety Cabinet for BD FACSAria Fusion Operator's Manual*.

Aerosol Management System

An AMS is incorporated into the BSC to rapidly evacuate aerosolized particles from the sort collection chamber during sorting or analysis. Equipped with a separate HEPA filter, the AMS operates independently of the BSC. The AMS will continue to operate if the BSC blower fails, providing an additional level of biosafety protection.

AMS Gauge and Controls

The AMS air flow gauge and controls are located on the front of the BSC in the lower right corner, to the left of the BSC controls.

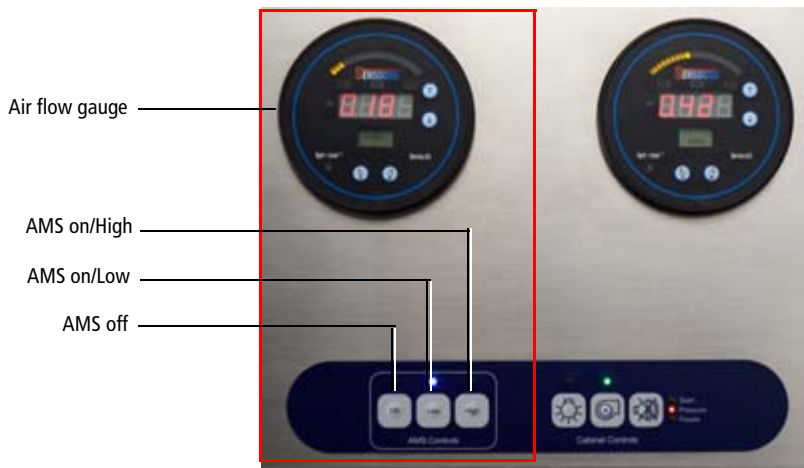

Air Flow Gauge

The air flow gauge indicates the amount of suction being applied to evacuate the sort collection chamber and the aspirator drawer. The air flow is measured in cubic feet per minute (CFM).

The air flow value should be:

- Low: 14 CFM \pm 1 CFM
- High: >26 CFM

See Buttons and LED Indicators and Audible Alarms on page 335.

Buttons and LED Indicators

The following table describes the functions of the AMS control buttons and the meaning of the LED indicators located above each button.

Button	Function	LED Color	Comments
AMS off	Turns the AMS off	Blue	Turn the AMS off when it is not in use.
AMS on/Low	Turns the AMS and low suction on. Turns low suction off.	Blue	Use low suction during normal sorting.
AMS on/High	Turns the AMS and high suction on. Turns high suction off.	Blue	Use high suction while removing a clog.

Audible Alarms

An LED indicator will flash above the corresponding button when there is an alarm condition. The following table describes the meaning of the LED indicators and the alarms and conditions that trigger them.

LED Indicator	LED Color	Audible Alarm?	Condition
AMS on/Low	Flashing orange	Yes	The air flow is outside the range of 14 ± 1 CFM. (This also occurs when the AMS is first turned on.)
AMS on/High	Flashing orange	Yes	The air flow is <26 CFM. (This also occurs when the AMS is first turned on.)

Operating the AMS



The AMS does not eliminate the health risks of working with biohazardous material and must be used in conjunction with good laboratory practice.

- 1 To turn on the AMS, press either the Low or the High button.
 - A blue indicator LED is illuminated over the button.
 - The air flow gauge goes through a startup sequence and then equilibrates.
- 2 Operate the AMS in:
 - Low during normal sorting.
 - High while removing a clog. See Responding to a Nozzle Clog During a Sort on page 336 to troubleshoot a nozzle clog.
- 3 Press the AMS Off button to turn off the AMS.

- A blue indicator LED is illuminated over the AMS off button.
- The flow air gauge shuts off.

Responding to a Nozzle Clog During a Sort

If the stream is disturbed during the sort (due in part to a clogged nozzle), the sort is designed to stop automatically and block the sort tubes (if the Sweet Spot is on). The sort will not restart until the operator has cleared the clog. In the event of a nozzle clog, do not open the sort collection chamber door or access the sort tubes before following this procedure.



Cell sorters that use droplet generation methods, such as the BD FACSAria Fusion, can produce aerosols around the sample stream. When acquiring biohazardous samples, follow universal precautions at all times. Keep the sort block door and the sort collection chamber door closed during sorting. Follow these steps to stop sample flow and evacuate potential aerosols before opening the sort collection chamber door.

To clear a clogged nozzle on a system with the AMS:

- 1 Keep the sort chamber door closed.
- 2 If the stream has not already shut down automatically, turn off the stream by clicking the **Stream** button (with a checkmark) at the top of the **Breakoff** window.

This will shut off the stream, unload the sample, and close the aspirator drawer.

- 3 Increase the air evacuation rate to high.
- 4 Open the aspirator drawer using the software controls (see Figure 1-12 on page 32).
- 5 Wait at least 60 seconds.

This procedure will clear aerosols from the sort chamber.

- 6** Close the aspirator drawer.
- 7** Turn on the stream and view the breakoff.

If the clog is removed, the breakoff will be similar to the breakoff before the clog.
- 8** If the clog is not cleared, turn the stream on and off several times to see if the clog has cleared.
- 9** If the clog is not removed, turn the stream off and perform the Clean Flow Cell procedure with DI water (see *Cleaning the Flow Cell (Daily)* on page 206), followed by turning the stream on to see if the clog has cleared.
- 10** Open the aspirator drawer and evacuate for at least 60 seconds before closing the aspirator drawer again.
- 11** You can now open the sort collection chamber and remove the sort collection device.
- 12** If it is necessary to change nozzles or remove a clog from a nozzle, see *Cleaning the Integrated Nozzle* on page 233.



- All cytometer surfaces that come in contact with biological specimens can transmit potentially fatal disease. Use universal precautions when cleaning cytometer surfaces. Wear suitable protective clothing, eyewear, and gloves.
- 13** With stream turned off, open the sort block door and dry the plates and surfaces as needed.
 - 14** When removing collection tubes, be aware that the outside of the tube is potentially contaminated. Use alcohol swabs or bleach to wipe the outsides of tubes.
 - 15** Press the AMS Low button.
 - 16** Make sure that all chamber doors are closed and restart the stream.
 - 17** Perform these tasks if needed:

- Turn on the Sweet Spot
- Check the drop delay
- Check the side stream deflection

Working in the BSC

When working inside the BSC, we recommend that you:

- Keep the blower on at all times.
- Keep the AMS on while sorting.
- Keep the view screen closed to the safe-access opening of 8 inches each time you work in the BSC.
- Do not work in the BSC if an alarm sounds and the corresponding indicator is illuminated. See the The Baker Company *Biosafety Cabinet for BD FACSAria Fusion Operator's Manual* for troubleshooting information. If additional assistance is required, contact your local BD Biosciences technical support representative or supplier.
- Do not block the intake grilles or the diffusers because it obstructs air flow.
- Do not store anything in front of the cytometer. Keep sample tubes and racks, squirt bottles, and other similar items inside the instrument storage cabinet to prevent obstruction of air flow.

NOTE Consult a qualified safety professional for decontamination procedures appropriate for you laboratory.

- Decontaminate the BSC and cytometer before:
 - Turning off the blower.
 - Having maintenance or service performed.

- Keep the blower on at all times and keep the view screen closed when the BSC is not being used, especially if you want the inside of the BSC to remain contamination-free.
- Use an adjustable chair for comfort.

Cleaning the BSC

Use this procedure to clean the BSC after sorting potentially infectious agents.

Materials

- 10% chlorine bleach (0.5% sodium hypochlorite) solution



Bleach can cause stainless steel to pit and crack. Ensure that you wipe down the BSC with 70% isopropyl alcohol to remove the bleach solution.

- 70% isopropyl alcohol
- Paper towels

Procedure



Any surface that comes in contact with biological specimens can transmit potentially fatal disease. Use universal precautions when cleaning the BSC. Wear suitable protective clothing, eyewear, and gloves.

To clean the BSC:

- 1 Wipe down the following areas using paper towels and 10% bleach (0.5% sodium hypochlorite) solution:
 - Floor of the BSC in front of the cytometer, and on each side
 - Inside and outside surfaces of the view screen

- Armrest/bypass
 - Cabinet Controls panel
 - Any other areas that might be contaminated
- 2 Repeat step 1 using 70% isopropyl alcohol.

Cleaning the Base Pan

NOTE Before cleaning the base pan, clean the inside of the BSC. See Cleaning the BSC on page 339.

Use the following procedure to clean the base pan.

Materials



- 10% chlorine bleach (0.5% sodium hypochlorite)



Bleach can cause stainless steel to pit and crack. Ensure that you wipe down the BSC with 70% isopropyl alcohol to remove the bleach solution.

- 70% isopropyl alcohol
- Paper towels
- A cleaning tool to reach into the base pan

Procedure

  Any surface that comes in contact with biological specimens can transmit potentially fatal disease. Use universal precautions when cleaning the base pan. Wear suitable protective clothing, eyewear, and gloves.

To clean the BSC:

- 1 Press in on the armrest/bypass and lift it up.



- 2 Remove the armrest/bypass.
- 3 Wipe down the armrest/bypass using paper towels and 10% bleach (0.5% sodium hypochlorite) solution.
- 4 Wipe down the armrest/bypass using paper towels and 70% isopropyl alcohol.
- 5 Set the armrest/bypass aside.
- 6 Wipe down the base pan using a cleaning tool and a 10% bleach (0.5% sodium hypochlorite) solution. Ensure that you also wipe down the areas underneath the electronic cables.



- 7 Wipe down the base pan using a cleaning tool and 70% isopropyl alcohol.
- 8 Check the position of the tabs above the base pan on either side of the BSC.

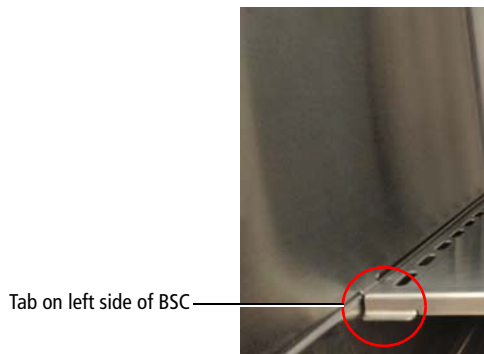

- 9 Reinstall the armrest/bypass by sliding it into position over the tabs.

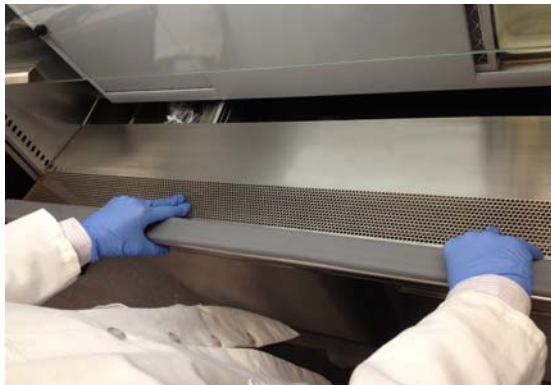

- 10 Lock the armrest/bypass into place by pushing it down and back so that the bottom snaps into place behind the lip of the base pan.

Replacing the Electronics Cable Plastic Sleeve

Some of the electronics cables for the BD FACSAria Fusion are located under the cytometer in the base pan. The cables are wrapped in plastic sleeves to protect the cables from exposure to liquids. When cleaning the base pan, check the plastic sleeves and replace them as necessary. Replacements are located in the spares kit.

To replace the plastic sleeves:

- 1 Remove the armrest/bypass by following step 1 through step 5 in the Cleaning the Base Pan procedure on page 340.
- 2 Check the plastic sleeves covering the electronic cables in the left and right sides of the base pan.

Figure 11-4 Electronic cables in the base pan



- 3 If necessary, remove the plastic sleeves by carefully removing the ties at each end of the sleeve and peeling off the plastic sleeve.
- 4 Wrap the cable bundles with new plastic sleeves and secure with ties at each end as shown in Figure 11-4.

Ergonomics Safety Guidelines

The following tables describe the monitor locations to provide optimum ergonomics for using the system monitors in a standing or seated station. A standing station is one where the operator stands or sits on a tall stool that places the operator at approximately the same height as standing, in front of the system monitors. A seated station is one where the operator sits on a short, office-style chair in front of the system monitor(s).

Table 11-1 Monitor location for standing stations

Display type	Height
Single monitor	147 cm (58 in.) (maximum)
	132 cm (52 in.) (minimum)
Stacked dual monitors (the primary monitor is the bottom monitor)	168 cm (66 in.) (maximum)

Table 11-2 Monitor location for seated stations

Display type	Height
Single monitor	51.7 cm (20.0 in.) (maximum)
	26.7 cm (10.5 in.) (minimum)
Stacked dual monitors (the primary monitor is the bottom monitor)	72.4 cm (28.5 in.) (maximum)
	26.7 cm (10.5 in.) (minimum)

Temperature Control Option

The BD™ temperature control option can be used to control the temperature of sorted samples in the BD FACSAria Fusion flow cytometer.

The following topics are described:

- Option Components on page 346
- Using the BD Temperature Control Option on page 347
- Maintenance on page 354
- Specifications on page 355

Option Components

The BD temperature control option includes the following:

- A recirculating water bath
- Specially designed collection tube holders with ports for recirculating water

Tube holders are available in these styles: two-way 15-mL, four-way 12 x 75-mm, and four-way 1.5-mL Eppendorf tubes. See Figure 12-1.

Figure 12-1 Temperature control option components

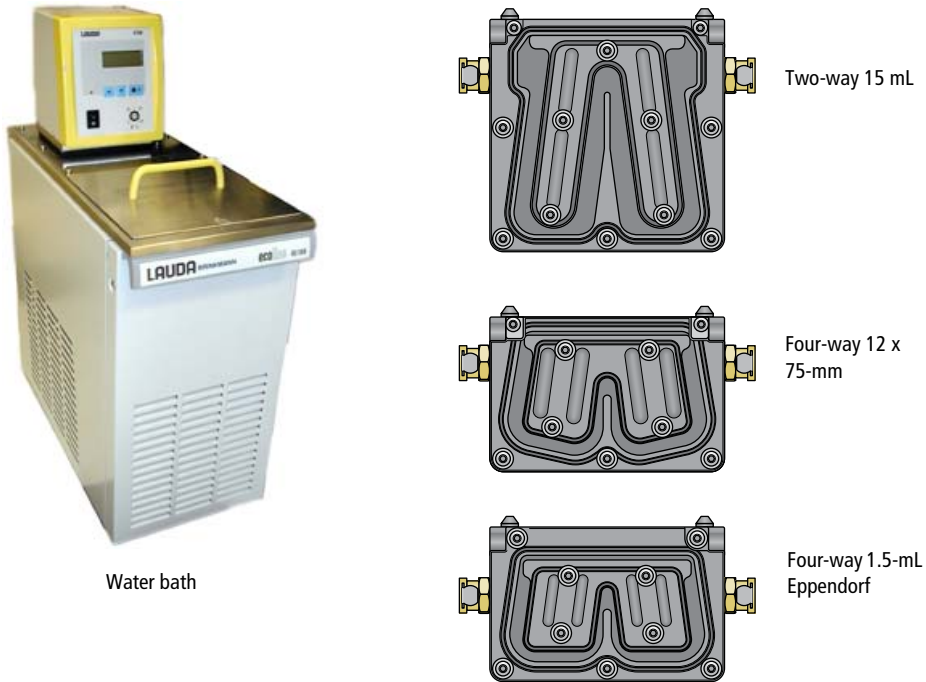



When acquiring biohazardous samples, follow universal precautions at all times. Keep the sort block door and the sort collection chamber door closed during sorting. We recommend that you use the BD Aerosol Management Option (for systems without a BSC) or the BD Aerosol Management System (for systems with a BSC) when sorting biohazardous samples into the temperature control tube holders. If the nozzle develops a clog, see Responding to a Nozzle Clog During a Sort with the AMO on page 310 or Responding to a Nozzle Clog During a Sort on page 336 (for systems with the AMS).

The BD temperature control option is For Research Use Only. It is not for use in diagnostic or therapeutic procedures.

Using the BD Temperature Control Option

Note that before you start the recirculating water bath, you must attach the tubing to the appropriate collection device.

Setting Up the Water Bath

- 1 Remove the threaded plug from the output port on the water bath.
- 2 Ensure that the drain cock on the back of the water bath is closed by turning it fully clockwise.
- 3 Set the pump outflow to maximum by turning the knob fully counter-clockwise.

Remove the top cover to access the knob, which is located inside the water bath toward the back. See the operating instructions supplied with the water bath for additional details on this process. This is referred to as position 1.

- 4 Connect the clear tubing end of the insulated hoses to the input and output ports on the water bath. (See Figure 12-2 on page 348.)

Slide the tubing over the hose barbs and twist gently while installing to get the tubing completely over the barbs.

Figure 12-2 Input and output ports on water bath



- 5 Connect the insulated hoses from the recirculating water bath to the ports on the right side of the cytometer base (Figure 12-3).

NOTE Because the water flow direction is controlled by the water bath pump, the ports on the cytometer base are multi-directional. The input and output hoses from the water bath can be connected to either port on the cytometer base.

Figure 12-3 Ports for temperature control option



- 6 Fill the water bath with distilled water containing 0.1 g/L of sodium carbonate.

Sodium carbonate helps reduce corrosion. See the water bath manufacturer's documentation for fill levels and other setup information.

NOTE We do not recommend using ethylene glycol (antifreeze) in the water bath.

- 7 Plug in the water bath power cord.

NOTE Do not start up the water bath until after you have connected the recirculating water tubing, as described in the following sections.

Setting Up the Tube Holder

This section describes how to install the temperature control tube holder on the instrument and how to attach the recirculating water tubing to the tube holder.



Any instrument surface that comes in contact with biological specimens can transmit potentially fatal disease. Use universal precautions when handling sorting hardware. Wear suitable protective clothing and gloves.

- 1 Place collection tubes in the temperature control tube holder.

Tube holders are available for 15-mL two-way sorting, 12 x 75-mm four-way sorting, and 1.5-mL Eppendorf tube four-way sorting. For compatible tubes, see Supplies and Consumables on page 275.

- 2 Attach the recirculating water tubing to the tube holder.
 - a Close the sort block door and open the sort collection chamber door, if needed. (The sort block door must be closed to open the collection chamber door.)

Note that the tubing ports are labeled *In* and *Out*. Attach the input tubing to the port on the left side of the collection tube holder, and the output tubing to the port on the right side, as shown in Figure 12-4 on page 350.

- b To attach the tubing, push it into the port until the tubing snaps into place.

Figure 12-4 Setting up the temperature control tube holder

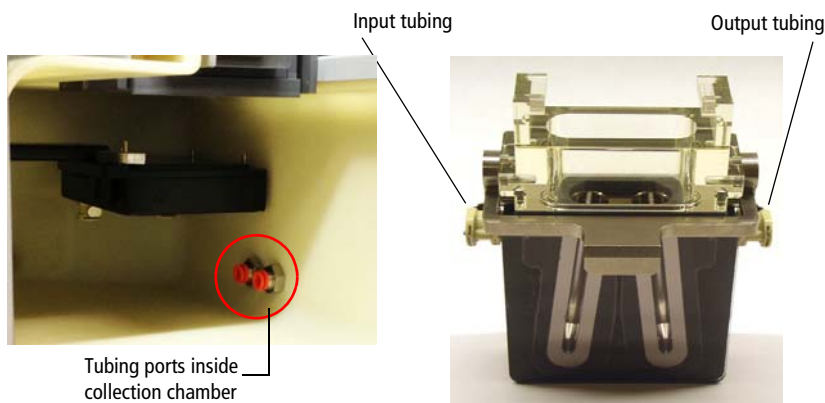

If you need to remove the tubing, push in the orange collar as you pull the tubing out of the port.



- 3** Install the tube holder on the instrument.

Remove the current tube holder (if one is installed), and slide the temperature control tube holder into the slotted fittings below the sort aspirator drawer. Push the tube holder all the way in.

- 4** Close the sort collection chamber door and start up the water bath.

Setting Up the ACDU Stage

This section describes how to attach the recirculating water tubing to the stage used with the automated cell deposition unit (ACDU).

  Any instrument surface that comes in contact with biological specimens can transmit potentially fatal disease. Use universal precautions when handling sorting hardware. Wear suitable protective clothing, eyewear, and gloves.

- 1** Install the splash shield below the aspirator drawer.

Figure 12-5 Setting up the temperature control on ACDU stage

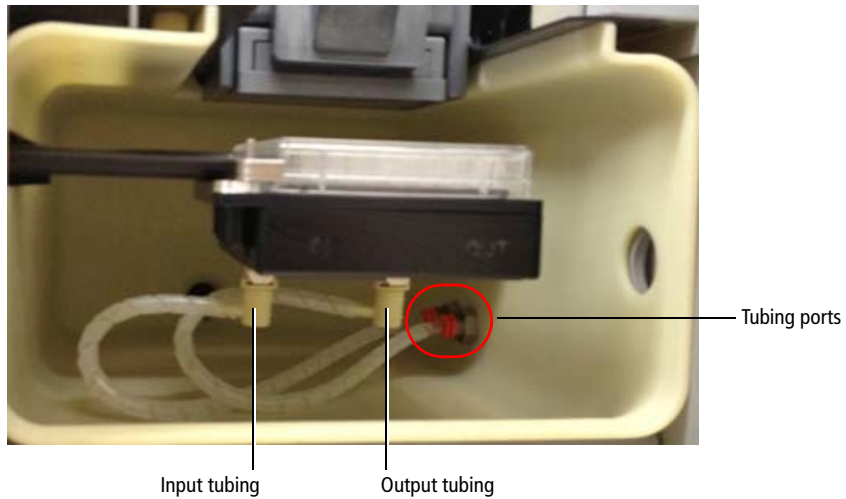

If you need to remove the tubing, push in the orange collar as you pull the tubing out of the port.

- 4** Install the appropriate collection device on the stage.
- 5** Close the sort collection chamber door and start up the water bath.

Starting Up the Water Bath

NOTE To ensure that the sample collection device is at the correct temperature, start up the water bath (115-V and 110-V models) at least 90 minutes before you start sorting.

- 1 Switch on the main power on the water bath control panel.

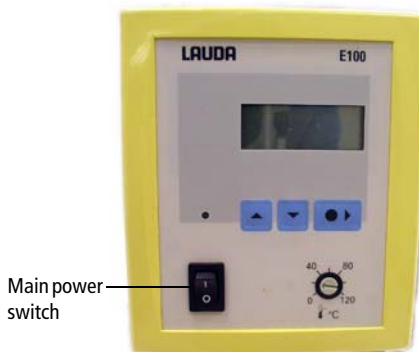

- 2 Use the up or down arrow keys to set the required temperature.

NOTE To achieve the required sample temperature, you will need to set the water bath temperature slightly higher or lower (see Table 12-1). These settings might need adjustment depending on the ambient temperature in your laboratory. We recommend that you calibrate the water bath for your operating environment.

Table 12-1 Water bath settings for corresponding sample temperature

Required Sample Temp (°C)	Water Bath Setting (°C)
4	2
37	37.5
42	43.2

- 3 Wait at least 90 minutes to allow the recirculating water to reach the required temperature.

Maintenance

To maintain the recirculating water bath, see the documentation provided by the manufacturer.

Tube Holders

Remove the tube holders when you are finished using them, and clean them periodically before storage.



When you detach the recirculating water tubing from the tube holder, any fluid remaining in the tubing can leak into the sort collection chamber. To ensure that fluid is aspirated from the sort collection chamber, make sure that the sort chamber aspirator pump is on (do not turn off the instrument main power) before you detach the tubing. Use caution when handling tubing containing hot water.

To detach the recirculating water tubing, push in the orange collar as you pull the tubing out of the port.

Clean the temperature control tube holders by wiping them down with an appropriate cleaning fluid (for example, 70% ethanol, 5% bleach, or DI water). Dry them with a lint-free cloth before storage.

Recirculating Water Tubing

Inspect the tubing periodically for leaks, plugs, or contaminants. If needed, remove the tubing and clean it with an appropriate cleaning solution, or replace the tubing. Contact your BD Biosciences service representative for replacement tubing.

Specifications

Specifications for the recirculating water bath are as follows.

NOTE The following specifications are for the US version only.

The temperature control option includes the Lauda® Ecoline cooling/heating bath, model RE 106.

- Operating temperature range: -20°C – 20°C
- Ambient temperature range: 5°C – 40°C
- Heater power for 115 V/60 Hz: 1.3 kW
- Maximum flow rate at pump output of 5: 17 L/min
- Maximum bath volume: 4–6 L
- Power consumption for 115 V/60 Hz: 1.4 kW

For more information, see the manufacturer's documentation.

THIS PAGE INTENTIONALLY LEFT BLANK

Index

Numerics

4-Way Purity mode 77

A

aborts

See also conflicts, sort
electronic 270

Access Stage button 110

accessory kit, contents 278

Accudrop

about 71

beads, sorting in Initial mode 180

experiment 114, 176

optimizing drop delay 178

ACDU *See* automated cell deposition unit

acquisition

controls 100

events to record 156

troubleshooting 265

Acquisition Dashboard 100

adding

cytometer configurations 92

folders 149

sort layouts 107, 184

sort populations 107, 184

adjusting

amplitude 68, 123

area scaling 143, 144, 145

Drop 1 68, 125

drop delay 178

flow rate 50, 100

Home location 194

laser delay 165

micrometer dial 179, 182

PMT voltages 62

side streams 194

sort block angle 31, 232

Window Extension 166

aerosol management option (AMO)

about 33

changing filters 229

components 304

evacuator components 305

maintenance 312

specifications 323

starting up the evacuator 306

troubleshooting 320

ULPA filter 305

using 303–323

agitating samples 85

air

external 44

filters, changing 229

line 119, 209

pressure 43

supply, external 44

air flow gauge

AMS 334

alarms

AMS 335

BSC 331, 332

AMO *See* aerosol management option
amplitude
 about 66
 adjusting 68, 123
AMS
 air flow gauge 334
 alarms 335
 buttons 334
 LED indicators 334
analysis
 batch 162
 data 155
 printing 161
 sorting 160, 171, 183
application settings
 about 141
 adjusting area scaling 143
 creating 142
 optimizing PMT voltages 146
 saving 147
 window 150
applications
 custom 92
 recommended flow rates 51
 recommended sort setup 103
area parameters 61
arrays, detector 40, 54
aseptic sorting 215
aspirator drawer
 about 32
 opening 70, 110, 186
assistance, technical xv
attenuation control 70
auto drop delay
 about 72
 graph 182
 overview 181
 using 181
autoclaving sheath tank 215

automated cell deposition unit (ACDU)
 about 34
 accessing stage 110
 chamber 34
 collection devices 195
 custom devices 197
 installing splash shield 192
 sorting 192
 troubleshooting 261

B

backflush, sample line 212
bandpass filters 57
base configurations 94
base pan
 cleaning 340
batch analysis, performing 162
BD FACSAria Fusion
 about 18
 cytometer 21
 workstation 19
BD FACSDiva software *See* software
beads
 Accudrop 178
 calibration 282
 CS&T research 138
 setup 136
beam splitters 56
biexponential
 display 158
 sort gates 183
bleach fluid line 216
bleeding filters 217
breakoff
 drop 65
 setting up 123–125
 troubleshooting 123, 259
 window 66, 102

- BSC
 - alarms 331, 332
 - cleaning 339
 - LED indicators 331
 - maintenance 339
 - ready safe mode 329
 - safe work access 328
 - sash 328
 - view screen 327
- bubble detector 27
- bulk sorting 171
- buttons
 - See also* controls
 - Access Stage 110
 - AMS 334
 - chamber light 26
 - emergency stop 44
 - Load 100
 - Sort 109
 - Unload 100
 - waste drawer 70
- C**
- calculating compensation 152
- cameras
 - about 42, 71
 - cleaning windows 244
- cap, waste 133
- chambers
 - ACDU 34
 - sample injection 26
 - sort block 30
 - sort collection 34
- changing
 - air filters 229
 - ethanol shutdown filter 220
 - fluid filters 218
 - nozzles 231
 - optical filters 249
 - pinch valve tubing 241
 - sample lines 221
 - sheath filters 219
 - waste cap 133
- charging drops 72
- cleaning
 - base pan 340
 - BSC 339
 - camera windows 244
 - cytometer 210, 212
 - flow cell 206
 - fluidics 215
 - mode failure 272
 - modes 212
 - nozzles 233
 - optical filters 250
 - strobe lens 245
- clogged nozzle
 - cleaning 233
 - responding to during a sort 190
 - responding to during a sort with
 - AMO 310
 - responding to during a sort with
 - AMS 336
- closed-loop nozzle
 - cleaning 237
 - for shutdown 206
 - installing 208
 - maintenance 237
 - replacing tubing 238
- coefficient of variation (CV), high 269
- collection
 - devices 34, 105
 - optics 39
 - tubes, replacing 188
- collet fitting 225

- compensation
 - calculating 152
 - controls, creating 151
 - gating data 154
 - setup 154
- components
 - AMS 335
 - BD FACSDiva workspace 82, 101
 - BSC 20
 - cytometer 21
 - electronics 43
 - fluidics 25
 - optics 35
 - workstation 19
- computer
 - about 19
 - shutting down 207, 210
- configuration, cytometer
 - about 59, 87, 88
 - adding 92
 - and sort setup 98
 - copying 94
 - custom 92
 - editing 96
 - mismatch dialog 140
 - selecting 136
- conflicts, sort
 - about 73
 - counting 110
 - printing 112
 - saving 108, 184
 - troubleshooting 263
- connecting
 - external air 44
- containers
 - about 22
 - autoclaving 215
 - emptying waste 132
 - refilling 130
- containment device, sheath probe 214
- controls
 - See also* buttons
 - ACDU stage 110
 - acquisition 100
 - aspirator drawer 70, 110
 - attenuation 70
 - BSC 329
 - compensation 151
 - cytometer (software) 83
 - flow rate 100
 - fluidics 83
 - optical filter 70, 71
 - sorting 101, 102, 109
 - stream 66
 - Sweet Spot 66
 - test sort 70
 - tube loading 100
 - voltage 70
 - waste drawer 70
- conventions, user's guide xiv
- cooling samples 85, 117
- cord, fluidics cart 43
- counters, sorting 110
- creating
 - analysis objects 160
 - application settings 142
 - compensation controls 151
 - custom devices 103, 197
 - folders 149
 - sort layouts 107, 184
 - sort precision modes 78
 - statistics view 161
- CS&T *See* Cytometer Setup and Tracking
- custom devices 103, 197
- custom optical filters 249
- customer support xv
- cuvette flow cell
 - about 28
 - cleaning 206

- cytometer
 - about 21
 - adding configurations 92
 - cleaning 210, 212
 - configuration 59, 87, 88, 136
 - controls, software 83
 - disconnect error 274
 - electronics 43
 - fluidics 25, 48
 - not responding 274
 - optics 35
 - performance 134
 - power 116
 - QC particles 282
 - shutting down 206, 207
 - starting 116
 - status report 90
 - supplies 276
 - workstation 19
- Cytometer Setup and Tracking (CS&T)
 - menu selections 87
 - overview 134
 - research beads 138
 - window 135

D

- daily shutdown procedure 206
- Dashboard, Acquisition 100
- data
 - analyzing 155, 160
 - gating 154, 160
 - recording 155, 159
- data collection, overview 148
- deflection
 - drop 73
 - plates 31, 172
 - removing 247
 - troubleshooting 262
- deflection plate removal tool 247

- delay
 - drop 70, 71, 176
 - See also* Accudrop
 - laser 63, 165
- deleting
 - custom devices 198
 - sort populations 109
 - sort precision modes 79
- detectors 40, 54, 59
 - detector configurations 289
 - detector locations 287
- devices, sorting 105, 197, 198
- diode laser 42, 71
- discriminating filters 57
- doors, sort collection chamber 35
- doublets
 - discrimination experiment 114
 - discrimination gating 149
 - eliminating 159
- drain plug 133
- drawer *See* aspirator drawer
- drop
 - auto delay 181
 - breakoff 65
 - charging 72
 - conflicts 73
 - correction factors 71, 173
 - deflection 73
 - delay 70, 71, 176, 178
 - See also* Accudrop
 - drive frequency 66
 - formation 65
 - satellites 124
- Drop 1
 - about 66, 67
 - adjusting 68, 125

E

- editing
 - cytometer configurations 96
 - sort layouts 109
 - statistics view 161
- electronics
 - aborts 270
 - about 43
 - signal processing 60
 - troubleshooting 274
- emergency stop button 44
- emission
 - spectra 53
- emptying waste 132
- error messages
 - cleaning mode failure 272
 - cytometer disconnected 274
 - cytometer not responding 274
 - Master DAQ overflow 274
- ethanol shutdown
 - filter, changing 220
 - tank
 - capacity 126
 - refilling 129
- events
 - not showing in plots 265, 267
 - rate, troubleshooting 268, 269
 - target 107, 184
 - troubleshooting 270
- excitation optics 36
- Experiment Layout 156
- experiments
 - Accudrop 114, 176
 - cytometer QC 114
 - doublet discrimination 114
 - setting up 156
 - sorting 184
 - templates 114
- exporting sort reports 113, 187

F

- FACSAria Fusion *See* BD FACSAria Fusion
- FACSDiva software *See* software
- ferrules, removing 224, 227
- fiber optics 37
- filling containers 130
- filters
 - about 55
 - air, changing 229
 - bandpass 57
 - changing 218, 249
 - discriminating 57
 - fluid, changing 218
 - holders 278
 - longpass 56
 - neutral density (ND) 58, 251, 278
 - optical 55, 250
 - purging 217
 - removing 218, 251
 - sample line 239, 240
 - sheath 219
- Fine Tune mode 78
- flow cell
 - about 28
 - access door 185
 - cleaning 206
- flow rate
 - about 51
 - adjusting 50, 100
 - recommendations 51
- fluid
 - bleach line 216
 - containers 22
 - filters 218
 - level indicators 86
 - line 119, 209
 - movement 48

- out port 217
- priming 131, 213
- refilling 130
- fluidics
 - about 48
 - cleaning 215
 - components 25
 - containers 22
 - controls 83
 - daily shutdown 206
 - level indicators 86
 - power 43
 - shutdown 84, 207
 - startup 49, 83, 119
 - system 48
 - troubleshooting 272
- fluidics cart
 - cord 121
 - power 43
- fluorescence
 - about 53
 - emission spectra 53
 - signal, troubleshooting 266
- folders, adding 149
- forward scatter (FSC)
 - about 52
 - detector 59
 - ND filter 251, 278
 - removing 251
- frequency, drop drive 66
- FSC *See* forward scatter

G

- Gap 66, 67
- gating
 - compensation controls 154
 - data 160
 - during sorting 183

- global worksheets
 - adding sort layouts 107, 184
 - previewing data 155
 - setting up 157

H

- hardware, ACDCU 192
- hazard symbols xiv
- hazards, mechanical 44
- heating samples 85, 117
- height parameters 61
- holders
 - collection tube 34, 171, 350
 - optical filter 278
 - sample tube 28
- Home Device 103, 194, 195
- hydrodynamic focusing 51

I

- index sorting
 - description 199
 - setting up for 199
- Initial mode 78
- installing
 - collection tube holders 171, 350
 - nozzle 231
 - plates 193, 352
 - sample line filter 239
 - sample tubes 28
 - slides 193, 352
 - splash shield 192
- instrument *See* cytometer
- integrated nozzle
 - about 29
 - changing 231
 - cleaning 233
 - replacing seal 236
- interrogation point 28

L

- labels, parameter 156
- label-specific tubes 151
- labware, parts list 284
- lasers
 - about 36
 - configurations 37
 - delay 63, 165
 - diode 42, 71
 - laser options 285
 - shutting down 207, 210
 - starting 116, 117
 - warmup time 116, 117
- layout *See* sort layouts
- leaks, troubleshooting 273
- LED indicators
 - AMS 334
 - BSC 331
- lens, strobe 245
- levels
 - fluid 86
 - sample 26
- lever, nozzle 120, 231
- light
 - detection 54
 - injection chamber 26
 - scatter signals 52
 - voltage warning 31
- limitations xvi
- Link & Save 154
- Load button 100
- loader, plate 35
- loading tubes 28, 50
- long clean 272
- longpass filters 56

M

- maintenance
 - AMO 312
 - BSC 339
 - scheduled 211
 - temperature control option 354
 - unscheduled 230
- managing aerosols 32
 - AMO 306
 - AMS 335
- Masks
 - about 73
 - default precision modes 77
 - Phase 76
 - Purity 75
 - Yield 74
- Master DAQ overflow error 274
- micrometer dial 42, 179, 182
- mirrors, dichroic 56
- mismatch dialog
 - configuration 140
 - cytometer settings 151
- modes
 - defining 78
 - deleting 79
 - sort precision 73, 77
- monitoring sorts 111, 187

N

- ND filters 58, 251, 278
- neutral density filters 58, 251, 278
- nozzles
 - See also* closed-loop nozzle
 - about 29
 - breakoff patterns 125
 - changing 231
 - cleaning 233
 - integrated 29

- lever 120, 231
- O-ring 279
- responding to clogs 190
- responding to clogs with AMO 310
- responding to clogs with AMS 336
- sizes 103, 231
- spare 279

O

- octagon
 - about 39, 40, 54
- opening
 - aspirator drawer 70, 110, 186
 - sample injection chamber 28
- Optical Filter control 70, 71
- optical filters
 - about 55
 - changing 249
 - cleaning 250
 - custom 249
- optics
 - about 35
 - collection 39
 - excitation 36
 - fiber 37
 - filter holders 278
 - reordering 276
 - stream-viewing 42
- optimizing
 - cytometer settings 148
 - drop delay 178
 - PMT voltages 146
 - streams 194
- ordering supplies 275
- O-ring
 - nozzle 279
 - sample injection chamber 248

P

- parameters
 - about 61
 - adding 59, 88, 92
 - labels 156
 - measuring 62
 - scatter, distorted 269
- parts, replacement 281
- pausing sorting 68, 110, 189
- performance
 - check, running 138
 - tracking 88
- phase
 - field 71
 - masks 74, 76
- photodiodes 59
- photomultiplier tubes (PMTs)
 - about 40, 59
 - applying voltages 62
 - assigning 59, 88, 92
 - optimizing for application settings 146
- pinch valve
 - changing tubing 241
 - collet fitting 243
- plate loader 35
- plate voltage 71
- plates
 - deflection 31, 172
 - removing 247
 - installing 193, 352
 - sorting into 192
- plots
 - excessive debris 270
 - no events in 265
 - unexpected events in 267
- PMTs *See* photomultiplier tubes
- populations
 - sorting 72, 107, 183, 184
 - troubleshooting 263, 270

- power
 - cytometer 116
 - fluidics cart 43
- precision modes 73, 77
 - See also* sort precision modes
- preferences, user 160
- pressure
 - air 43
 - sample 50
 - sheath 49, 84
 - sort, default values 103
 - troubleshooting 272
- priming fluids 131, 213
- printing
 - sort reports 113, 187
 - worksheets 161
- pulse, electronic 60
- purging filters 217
- Purity
 - Masks 75
 - mode 77, 184

Q

- quality control (QC)
 - experiment 114
 - particles 282

R

- ready safe mode 329
- reagents, parts list 283
- recording
 - data 155, 159
 - during sorting 186
- refilling
 - ethanol shutdown
 - tank 129
 - plastic containers 130
 - sheath tank 127
- removal tool, deflection plate 247

- removing
 - deflection plates 247
 - ferrules 224, 227
 - filters 218, 249, 251
 - sample line filter 239
- replacement parts 281
- replacing
 - closed-loop nozzle tubing 238
 - tubes 187
- reports
 - cytometer status 90
 - printing 113, 187
 - sort 112, 113
- results, troubleshooting 264
- rotating sort block 31, 232
- running performance check 138

S

- safety, general 44
- sample
 - agitation 85
 - core diameter 51
 - flow 48, 50
 - injection chamber
 - about 26
 - lubricating O-ring 248
 - sample line 240
 - interrogation 28
 - line
 - backflush 212
 - changing 221
 - filter 239, 240
 - pressure 50
 - temperature 85, 117
 - tubes, replacing 188
- samples
 - heating 85, 117
 - running 159

- sash
 - BSC 328
- satellites, drop 124
- Save Conflicts 108, 184
- saving
 - application settings 147
 - sort conflicts 108, 184
- scatter
 - light 52
 - parameters, distorted 269
- second laser
 - adjusting delay 165
- settings
 - See also* application settings
 - optimizing 148
- setup
 - beads 136
 - compensation 154
 - values, sort 103, 104
- sheath
 - flow 49
 - line 217
 - pressure 49, 84
 - reservoir, autoclaving 215
- sheath filter
 - changing 219
 - purging 218
- sheath probe
 - containment device 214
 - removing 213
- sheath tank
 - capacity 126
 - changing air filter 229
 - changing filter 219
 - connectors 127
 - refilling 127
 - required location 128
- shutdown tank, ethanol
 - capacity 126
 - refilling 129
- shutting down
 - computer 207, 210
 - daily procedure 206
 - fluidics 84, 206, 207
 - lasers 207, 210
- side scatter (SSC) 52
- side streams
 - optimizing 194
 - window 69, 102
- signals
 - about 52
 - detection 54
 - fluorescence 53
 - generating 60
 - low Area 267
 - no fluorescence 266
 - scattered light 52
 - troubleshooting 271
- Single Cell mode 78
- slides
 - installing 193, 352
 - sorting into 192
- software
 - about 19
 - cleaning modes 212
 - components 82, 101
 - cytometer controls 83
 - templates 114
- sort
 - block 30, 33
 - collection
 - chamber 34
 - devices 34
- Sort button 109
- sort layouts
 - about 72
 - creating 107, 184
 - custom 103, 197
 - editing 109
 - entering populations 107, 184

- sort menu 102
- sort precision modes
 - 4-Way Purity 77, 184
 - about 73
 - creating 78, 102
 - defaults 77
 - deleting 79
 - Fine Tune 78
 - Initial 78
 - Purity 77
 - Single Cell 78
 - Yield 78
- sort reports
 - about 112
 - exporting 113, 187
 - printing 113, 187
- sort setup values 103, 104
- sort, test 70, 173
- sorting
 - about 64, 169
 - Accudrop beads 180
 - analysis 160, 171, 183
 - aseptic 215
 - aspirator drawer control 70, 110
 - bulk 171
 - collection devices 105
 - conflicts 73, 108, 110, 184, 263
 - controls 101, 109
 - counters 110
 - experiment 184
 - gates 183
 - index 199
 - into plates 192
 - into slides 192
 - into tubes 171
 - monitoring 111, 187
 - pausing 68, 110, 189
 - populations 72, 107, 183, 184
 - recording data 186
 - resuming 187, 189
 - setup 170
 - starting 109, 185
 - stopping 109
 - troubleshooting 260
- specifications
 - temperature control option 355
- splash shield, installing 192
- stage, accessing 110
- starting
 - cytometer 116
 - fluidics 49, 83, 119
 - lasers 116, 117
 - sorting 109, 185
 - stream 121
- statistics view, creating 161
- status, cytometer report 90
- Stokes shift 53
- stop button 44
- stopping sorting 109
- stream
 - centering 70, 173
 - control 66
 - deflecting 71
 - flow rate 49
 - setting up 194
 - starting 121
 - troubleshooting 121, 254
 - viewing 42
- stream-charging wire 73
- strobe lens, cleaning 245, 246
- supplies, cytometer 276
- Sweet Spot
 - about 65, 68
 - control 66
- symbols, hazard xiv

T

- tanks *See* containers
- target events 107, 184

- technical assistance xv
- temperature control option
 - about 34
 - maintenance 354
 - setting up ACDU 350
 - specifications 355
 - using 346–355
 - water bath 347
- temperature, sample 85
- templates, experiment 114
- Terasaki plate adapter 203
- test sort 70, 173, 195
- threshold, troubleshooting 271
- trap, waste 133
- troubleshooting
 - ACDU 261
 - acquisition 265
 - AMO 320
 - breakoff 123, 259
 - CVs 269
 - deflection 262
 - electronic aborts 270
 - electronics 274
 - event rate 268, 269
 - fluidics cart 272
 - leaks 273
 - low Area signal 267
 - populations 263, 270
 - pressure 272
 - scatter parameters 269
 - signals 266, 271
 - sorting 260, 263, 264
 - stream 121, 254
 - threshold 271
- tubes
 - adding sort layouts 107, 184
 - agitating 85
 - compensation 151
 - heating/cooling 85, 117
 - holders 28, 34

- label-specific 151
- loading 28, 50
- replacing 188
- sorting into 34, 171
- unloading 28, 50
- typographical conventions xiv

U

- ULPA filter on AMO 305
- Unload button 100
- unloading tubes 28, 50
- user preferences 160

V

- View Configurations selection 88
- view screen
 - BSC 327
- viewing global worksheets 157
- views
 - statistics 161
- violet laser
 - configuration 37
 - detector 54, 277
 - laser delay 63
- voltage
 - adjusting PMT 62
 - controls 70
 - optimizing PMT 146
 - warning light 31

W

- waste
 - aspirator 32
 - cap, changing 133
 - container parts 132
 - emptying 132
- water bath 347, 353
- width parameters 61

- Window Extension
 - adjusting 166
- windows
 - See also* views
 - about 82, 101
 - Acquisition Dashboard 100
 - Breakoff 66
 - camera, cleaning 244
 - CS&T 135
 - cytometer configuration 88
 - device setup 195
 - Side Stream 69
 - strobe lens 246
- worksheets
 - See also* global worksheets
 - printing 161
 - viewing 157
- workspace
 - components 82, 101
 - setting up 148
 - setting up CS&T 135
- workstation
 - about 19
 - shutting down 207, 210

X

- X-mount optical plate 38

Y

- Yield
 - mask 74, 76
 - mode 78